



WL4SLGC-3P2252A71

W4

MINIATURE PHOTOELECTRIC SENSORS

SICK
Sensor Intelligence.



Illustration may differ

Ordering information

Type	Part no.
WL4SLGC-3P2252A71	1080955

The sensor is equipped with a special Smart Task function. Additional information can be found in the "Technical Data." Use of the sensor for pure object detection is limited.

Other models and accessories → www.sick.com/W4



Detailed technical data

Features

Functional principle	Photoelectric retro-reflective sensor
Functional principle detail	Without reflector minimum distance (autocollimation/coaxial optics)
Sensing range max.	0 m ... 3.5 m ^{1) 2)}
Sensing range	0 m ... 2.2 m ^{1) 2)}
Polarisation filters	Yes
Emitted beam	
Light source	Laser ³⁾
Type of light	Visible red light
Light spot size (distance)	Ø 0.4 mm (60 mm)
Key laser figures	
Normative reference	EN 60825-1:2014, IEC 60825-1:2014 / CDRH 21 CFR 1040.10 & 1040.11
Laser class	1
Wave length	650 nm
Adjustment	IO-Link, Single teach-in button

¹⁾ Reflective tape REF-AC1000.

²⁾ To ensure reliable operation, we recommend using REF-AC1000 reflective tape or reflective-tap reflectors such as P41F, PLV14-A, PLH25-M12, or PLH25-D12. Reflectors with large-scale triple structures must only be used if deemed suitable for the application.

³⁾ Average service life: 50,000 h at T_U = +25 °C.

Special applications	Detecting transparent objects, Detecting small objects
Mounting hole	M3
Pin 2 configuration	External input, Teach-in input, Sender off input, Detection output, logic output, Device contamination alarm output
AutoAdapt	✓

¹⁾ Reflective tape REF-AC1000.

²⁾ To ensure reliable operation, we recommend using REF-AC1000 reflective tape or reflective-tap reflectors such as P41F, PLV14-A, PLH25-M12, or PLH25-D12. Reflectors with large-scale triple structures must only be used if deemed suitable for the application.

³⁾ Average service life: 50,000 h at $T_J = +25\text{ °C}$.

Safety-related parameters

MTTF_D	562 years (EN ISO 13849-1) ¹⁾
DC_{avg}	0 %
T_M (mission time)	10 years

¹⁾ Mode of calculation: Parts-Count-calculation.

Communication interface

IO-Link	✓, COM2 (38,4 kBaud)
Data transmission rate	COM2 (38,4 kBaud)
Cycle time	2.3 ms
Process data length	16 Bit
Process data structure	Bit 0 = switching signal Q _{L1} Bit 1 = switching signal Q _{L2} Bit 2 ... 15 = measuring value
VendorID	26
DeviceID HEX	0x800119
DeviceID DEC	8388889

Electrical data

Supply voltage U_B	10 V DC ... 30 V DC ¹⁾
Ripple	< 5 V _{pp} ²⁾
Current consumption	30 mA ³⁾
Protection class	III
Digital output	
Type	PNP ⁴⁾ ⁵⁾
Switching mode	Light/dark switching ⁴⁾

¹⁾ Limit values when operated in short-circuit protected network: max. 8 A.

²⁾ May not fall below or exceed U_y tolerances.

³⁾ Without load.

⁴⁾ Q = light switching.

⁵⁾ Pin 4: This switching output must not be connected to another output.

⁶⁾ Signal transit time with resistive load.

⁷⁾ Valid for Q \ on Pin2, if configured with software.

⁸⁾ With light/dark ratio 1:1.

⁹⁾ A = V_S connections reverse-polarity protected.

¹⁰⁾ B = inputs and output reverse-polarity protected.

¹¹⁾ C = interference suppression.

¹²⁾ With light / dark ratio 1:1, valid for Q \ on Pin2, if configured with software.

Output current $I_{\max.}$	≤ 100 mA
Response time	≤ 0.5 ms ⁶⁾
Repeatability (response time)	150 μ s ⁷⁾
Switching frequency	1,000 Hz ⁸⁾
Output function	Complementary
Circuit protection	A ⁹⁾ B ¹⁰⁾ C ¹¹⁾
Response time Q/ on Pin 2	300 μ s ... 450 μ s ^{6) 7)}
Switching frequency Q / to pin 2	1,000 Hz ¹²⁾

- 1) Limit values when operated in short-circuit protected network: max. 8 A.
 2) May not fall below or exceed U_V tolerances.
 3) Without load.
 4) Q = light switching.
 5) Pin 4: This switching output must not be connected to another output.
 6) Signal transit time with resistive load.
 7) Valid for Q \ on Pin2, if configured with software.
 8) With light/dark ratio 1:1.
 9) A = V_S connections reverse-polarity protected.
 10) B = inputs and output reverse-polarity protected.
 11) C = interference suppression.
 12) With light / dark ratio 1:1, valid for Q \ on Pin2, if configured with software.

Mechanical data

Housing	Rectangular
Design detail	Slim
Dimensions (W x H x D)	12.2 mm x 41.8 mm x 17.3 mm
Connection	Male connector M8, 4-pin
Material	
Housing	Plastic, Novodur
Front screen	Plastic, PMMA
Weight	100 g

Ambient data

Enclosure rating	IP66 IP67
Ambient operating temperature	-10 °C ... +50 °C
Ambient operating temperature extended	-30 °C ... +55 °C ^{1) 2)}
Ambient temperature, storage	-30 °C ... +70 °C
UL File No.	NRKH.E181493
RoHS certificate	✓

- 1) As of $T_a = 50$ °C, a max. supply voltage $V_{\max.} = 24$ V and a max. load current $I_{\max.} = 50$ mA is permitted.
 2) Operation below $T_u -10$ °C is possible if the sensor is already switched on at $T_u > -10$ °C, then cools down, and the supply voltage is subsequently not switched off. Switching on below $T_u -10$ °C is not permissible.

Smart Task

Smart Task name	Counter + debouncing
Logic function	Direct WINDOW Hysteresis
Timer function	Deactivated Switch-on delay Off delay ON and OFF delay Impulse (one shot)
Inverter	Yes
Maximum counting frequency	SIO Direct: --- ¹⁾ SIO Logic: 1000 Hz ²⁾ IOL: 900 Hz ³⁾
Counter reset	SIO Direct: --- SIO Logic: 1,5 ms IOL: 1,5 ms
Min. Time between two process events (switches)	SIO Direct: --- SIO Logic: 450 µs IOL: 500 µs
Debounce time max.	SIO Direct: --- ¹⁾ SIO Logic: 450 µs ²⁾ IOL: 500 µs ³⁾
Switching signal	
Switching signal Q _{L1}	Output type (dependant on the adjusted threshold)
Switching signal Q _{L2}	Output type (dependant on the adjusted threshold)
Measuring value	Counting value

¹⁾ SIO Direct: sensor operation in standard I/O mode without IO-Link communication and without using internal sensor logic or time parameters (set to "direct"/"deactivated").

²⁾ SIO Logic: Sensor operation in standard I/O mode without IO-Link communication. Sensor-internal logic or timing parameters plus Automation Functions used.

³⁾ IOL: Sensor operation with full IO-Link communication and usage of logic, timing and Automation Function parameters.

Diagnosis

Device status	Yes
Quality of teach	Yes
Quality of run	Yes, Contamination display

Classifications

ECLASS 5.0	27270902
ECLASS 5.1.4	27270902
ECLASS 6.0	27270902
ECLASS 6.2	27270902
ECLASS 7.0	27270902
ECLASS 8.0	27270902
ECLASS 8.1	27270902
ECLASS 9.0	27270902
ECLASS 10.0	27270902
ECLASS 11.0	27270902
ECLASS 12.0	27270902

ETIM 5.0	EC002717
ETIM 6.0	EC002717
ETIM 7.0	EC002717
ETIM 8.0	EC002717
UNSPSC 16.0901	39121528

Connection diagram

Cd-363

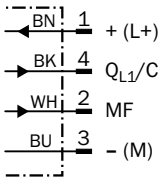

Characteristic curve

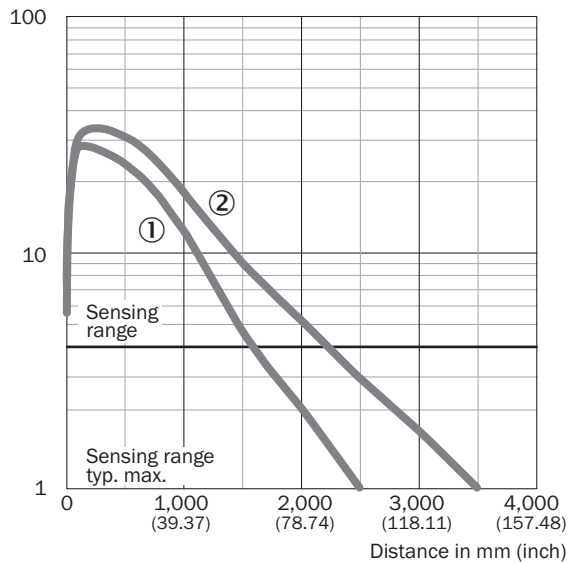

- ① Reflector PLV14-A / PLH25-M12 / PLH25-D12
- ② Reflector P41F / reflective tape REF-AC1000

Light spot size

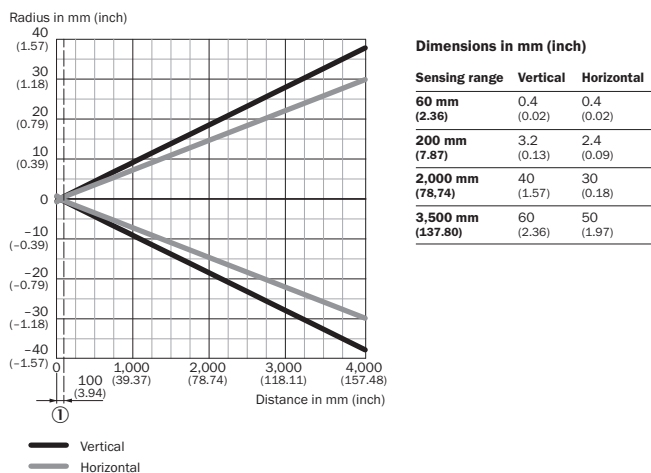

① Minimum distance between sensor and reflector

Light spot size (detailed view)

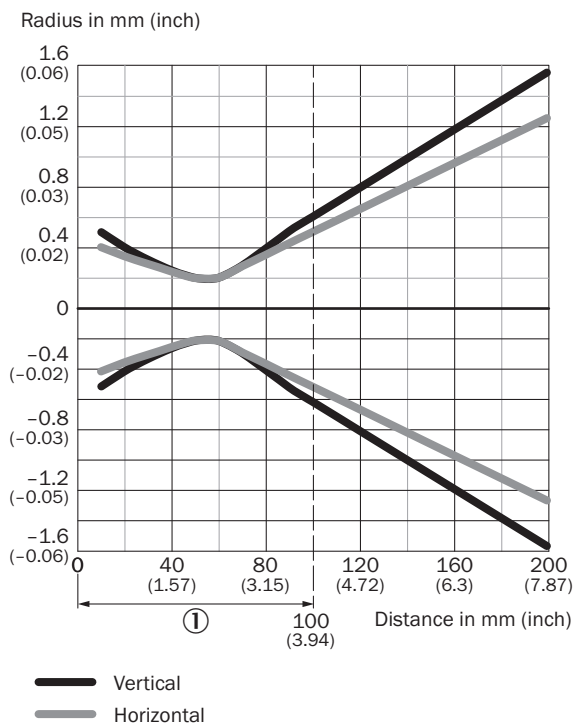

① Minimum distance between sensor and reflector

Sensing range diagram

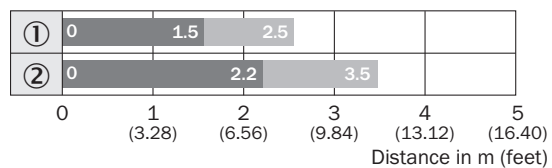

■ Sensing range ■ Sensing range max.

- ① Reflector PLV14-A / PLH25-M12 / PLH25-D12
- ② Reflector P41F / reflective tape REF-AC1000

Dimensional drawing (Dimensions in mm (inch))

WL4SL-3, WL4SLG-3, WSE4SL-3, plug

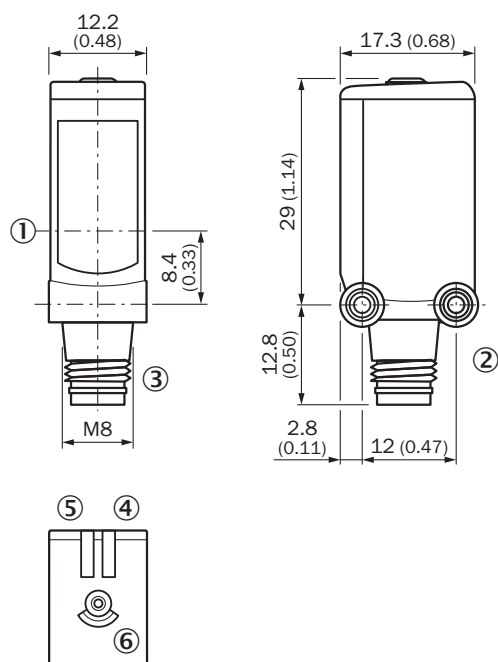





- ① Center of optical axis
- ② Threaded mounting hole M3
- ③ Connection
- ④ LED indicator green: Supply voltage active
- ⑤ LED indicator yellow: Status of received light beam
- ⑥ Single teach-in button

Recommended accessories

Other models and accessories → www.sick.com/W4

	Brief description	Type	Part no.
Mounting brackets and plates			
	Mounting bracket for floor mounting, Stainless steel 1.4571, mounting hardware included	BEF-W4-B	2051630

	Brief description	Type	Part no.
	Universal mounting bracket for reflectors, steel, zinc coated	BEF-WN-REFX	2064574
Reflectors			
	Suitable for laser sensors, self-adhesive, cut, see alignment note, 56.3 mm x 56.3 mm, self-adhesive	REF-AC1000-56	4063030
Others			
	<ul style="list-style-type: none"> • Connection type head A: Female connector, M8, 4-pin, straight, A-coded • Connection type head B: Flying leads • Signal type: Sensor/actuator cable • Cable: 5 m, 4-wire, PVC • Description: Sensor/actuator cable, unshielded • Application: Zones with chemicals 	YF8U14-050VA3XLEAX	2095889
	<ul style="list-style-type: none"> • Connection type head A: Male connector, M8, 4-pin, straight, A-coded • Description: Unshielded • Connection systems: Screw-type terminals • Permitted cross-section: 0.14 mm² ... 0.5 mm² 	STE-0804-G	6037323

Recommended services

Additional services → www.sick.com/W4

	Type	Part no.
Function Block Factory		
<ul style="list-style-type: none"> • Description: The Function Block Factory supports common programmable logic controllers (PLCs) from various manufacturers, such as Siemens, Beckhoff, Rockwell Automation and B&R. More information on the FBF can be found <a _blank"="" href="https://fbf.cloud.sick.com target=">here. • Note: You can configure your function block at <a _blank"="" href="https://fbf.cloud.sick.com target=">Function Block Factory. As a login please use your SICK ID. 	Function Block Factory	On request

SICK AT A GLANCE

SICK is one of the leading manufacturers of intelligent sensors and sensor solutions for industrial applications. A unique range of products and services creates the perfect basis for controlling processes securely and efficiently, protecting individuals from accidents and preventing damage to the environment.

We have extensive experience in a wide range of industries and understand their processes and requirements. With intelligent sensors, we can deliver exactly what our customers need. In application centers in Europe, Asia and North America, system solutions are tested and optimized in accordance with customer specifications. All this makes us a reliable supplier and development partner.

Comprehensive services complete our offering: SICK LifeTime Services provide support throughout the machine life cycle and ensure safety and productivity.

For us, that is “Sensor Intelligence.”

WORLDWIDE PRESENCE:

Contacts and other locations –www.sick.com