



WL4SL-3P3232

W4

MINIATURE PHOTOELECTRIC SENSORS

SICK
Sensor Intelligence.



Ordering information

Type	Part no.
WL4SL-3P3232	1061563

Other models and accessories → www.sick.com/W4

Illustration may differ



Detailed technical data

Features

Functional principle	Photoelectric retro-reflective sensor
Functional principle detail	Without reflector minimum distance (autocollimation/coaxial optics)
Sensing range max.	0 m ... 12 m ¹⁾
Sensing range	0 m ... 8 m ¹⁾
Polarisation filters	Yes
Emitted beam	
Light source	Laser ²⁾
Type of light	Visible red light
Light spot size (distance)	Ø 1 mm (500 mm)
Key laser figures	
Normative reference	EN 60825-1:2014, IEC 60825-1:2014 / CDRH 21 CFR 1040.10 & 1040.11
Laser class	1
Wave length	650 nm
Adjustment	Single teach-in button
Special applications	Detecting small objects
Mounting hole	M3

¹⁾ Reflector PL80A.

²⁾ Average service life: 50,000 h at T_U = +25 °C.

Safety-related parameters

MTTF_D	715 years (EN ISO 13849-1) ¹⁾
DC_{avg}	0 %

¹⁾ Mode of calculation: Parts-Count-calculation.

Electrical data

Supply voltage U_B	10 V DC ... 30 V DC ¹⁾
Ripple	< 5 V _{pp} ²⁾
Current consumption	30 mA ³⁾
Protection class	III
Digital output	
Type	PNP ⁴⁾
Switching mode	Light/dark switching ⁴⁾
Output current I _{max.}	≤ 100 mA
Response time	≤ 0.5 ms ⁵⁾
Switching frequency	1,000 Hz ⁶⁾
Output function	Complementary
Circuit protection	A ⁷⁾ B ⁸⁾ C ⁹⁾

¹⁾ Limit values when operated in short-circuit protected network: max. 8 A.

²⁾ May not fall below or exceed U_y tolerances.

³⁾ Without load.

⁴⁾ Q = light switching.

⁵⁾ Signal transit time with resistive load.

⁶⁾ With light/dark ratio 1:1.

⁷⁾ A = V_S connections reverse-polarity protected.

⁸⁾ B = inputs and output reverse-polarity protected.

⁹⁾ C = interference suppression.

Mechanical data

Housing	Rectangular
Design detail	Slim
Dimensions (W x H x D)	12.2 mm x 41.8 mm x 17.3 mm
Connection	Cable with M8 male connector, 4-pin ¹⁾
Connection detail	
Conductor size	0.14 mm ²
Length of cable (L)	120 mm ¹⁾
Material	
Housing	Plastic, Novodur
Front screen	Plastic, PMMA
Cable	Plastic, PVC
Weight	100 g

¹⁾ Do not bend below 0 °C.

Ambient data

Enclosure rating	IP66 IP67
Ambient operating temperature	-10 °C ... +50 °C
Ambient operating temperature extended	-30 °C ... +55 °C ^{1) 2)}
Ambient temperature, storage	-30 °C ... +70 °C

¹⁾ As of $T_a = 50\text{ °C}$, a max. supply voltage $V_{max.} = 24\text{ V}$ and a max. load current $I_{max.} = 50\text{ mA}$ is permitted.

²⁾ Operation below $T_u -10\text{ °C}$ is possible if the sensor is already switched on at $T_u > -10\text{ °C}$, then cools down, and the supply voltage is subsequently not switched off. Switching on below $T_u -10\text{ °C}$ is not permissible.

Classifications

ECLASS 5.0	27270902
ECLASS 5.1.4	27270902
ECLASS 6.0	27270902
ECLASS 6.2	27270902
ECLASS 7.0	27270902
ECLASS 8.0	27270902
ECLASS 8.1	27270902
ECLASS 9.0	27270902
ECLASS 10.0	27270902
ECLASS 11.0	27270902
ECLASS 12.0	27270902
ETIM 5.0	EC002717
ETIM 6.0	EC002717
ETIM 7.0	EC002717
ETIM 8.0	EC002717
UNSPSC 16.0901	39121528

Connection diagram

Cd-083

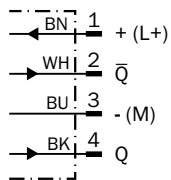

Characteristic curve

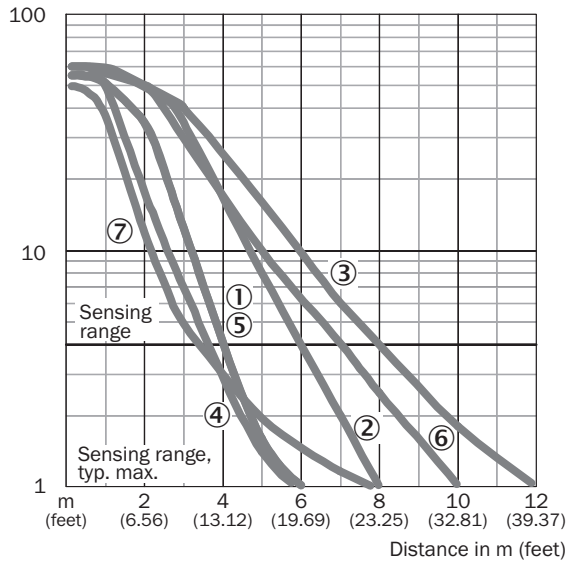

- ① Reflector PL20A
- ② Reflector PL40A
- ③ Reflector PL80A
- ④ PL10F reflector
- ⑤ Reflector PL20F
- ⑥ Reflector P250F
- ⑦ Reflective tape REF-AC1000

Light spot size

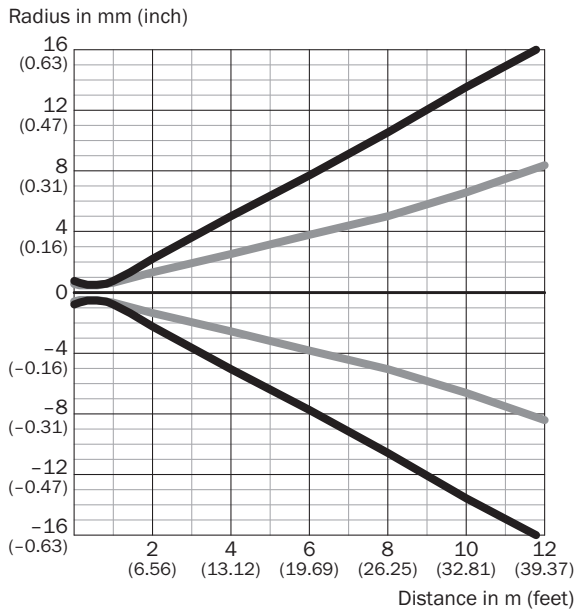

Dimensions in mm (inch)

Sensing range	Vertical	Horizontal
0.5 m (1.64 feet)	< 1.0 (0.04)	< 1.0 (0.04)
1 m (3.28 feet)	1.5 (0.06)	1.2 (0.05)
6 m (19.69 feet)	15.2 (0.60)	7.6 (0.30)
12 m (39.37 feet)	32.4 (1.28)	16.4 (0.65)

— Vertical
— Horizontal

Light spot size (detailed view)

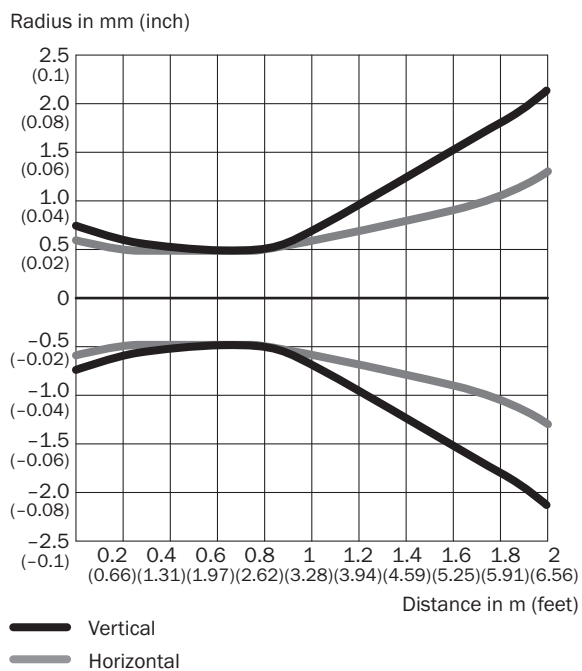

Sensing range diagram

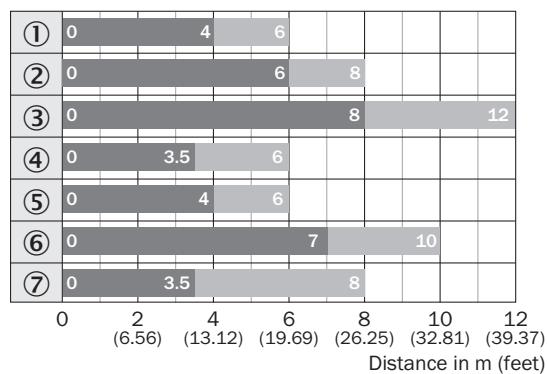

- ① Reflector PL20A
- ② Reflector PL40A
- ③ Reflector PL80A
- ④ PL10F reflector
- ⑤ Reflector PL20F
- ⑥ Reflector P250F
- ⑦ Reflective tape REF-AC1000

Dimensional drawing (Dimensions in mm (inch))

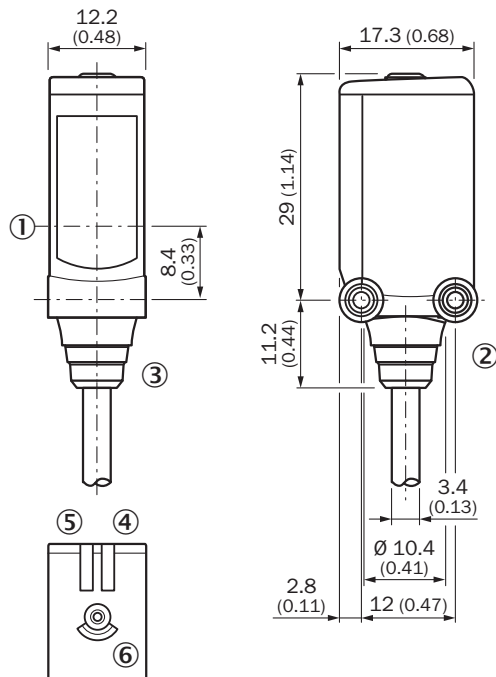

WL4SL-3, WL4SLG-3, WSE4SL-3, cable



- ① Center of optical axis
- ② Threaded mounting hole M3
- ③ Connection
- ④ LED indicator green: Supply voltage active
- ⑤ LED indicator yellow: Status of received light beam
- ⑥ Single teach-in button

Recommended accessories

Other models and accessories → www.sick.com/W4

	Brief description	Type	Part no.
Reflectors			
	Fine triple reflector, screw connection, suitable for laser sensors, 20 mm x 32 mm, PM-MA/ABS, Screw-on, 2 hole mounting	PL10F	5311210
Others			
	<ul style="list-style-type: none"> • Connection type head A: Female connector, M8, 4-pin, straight, A-coded • Connection type head B: Flying leads • Signal type: Sensor/actuator cable • Cable: 5 m, 4-wire, PVC • Description: Sensor/actuator cable, unshielded • Application: Zones with chemicals 	YF8U14-050VA3XLEAX	2095889
	<ul style="list-style-type: none"> • Connection type head A: Male connector, M8, 4-pin, straight, A-coded • Description: Unshielded • Connection systems: Screw-type terminals • Permitted cross-section: 0.14 mm² ... 0.5 mm² 	STE-0804-G	6037323

SICK AT A GLANCE

SICK is one of the leading manufacturers of intelligent sensors and sensor solutions for industrial applications. A unique range of products and services creates the perfect basis for controlling processes securely and efficiently, protecting individuals from accidents and preventing damage to the environment.

We have extensive experience in a wide range of industries and understand their processes and requirements. With intelligent sensors, we can deliver exactly what our customers need. In application centers in Europe, Asia and North America, system solutions are tested and optimized in accordance with customer specifications. All this makes us a reliable supplier and development partner.

Comprehensive services complete our offering: SICK LifeTime Services provide support throughout the machine life cycle and ensure safety and productivity.

For us, that is “Sensor Intelligence.”

WORLDWIDE PRESENCE:

Contacts and other locations –www.sick.com