



WL9GC-3P2432A70

W9

SMALL PHOTOELECTRIC SENSORS

SICK
Sensor Intelligence.



Illustration may differ



Ordering information

Type	Part no.
WL9GC-3P2432A70	1080919

The sensor is equipped with a special Smart Task function. Additional information can be found in the "Technical Data." Use of the sensor for pure object detection is limited.

Other models and accessories → www.sick.com/W9

Detailed technical data

Features

Functional principle	Photoelectric retro-reflective sensor
Functional principle detail	Without reflector minimum distance (autocollimation/coaxial optics)
Dimensions (W x H x D)	12.2 mm x 52.2 mm x 23.6 mm
Housing design (light emission)	Rectangular
Mounting hole	M3
Sensing range max.	0 m ... 5 m ¹⁾
Sensing range	0 m ... 3 m ¹⁾
Type of light	Visible red light
Light source	PinPoint LED ²⁾
Light spot size (distance)	Ø 45 mm (1.5 m)
Wave length	650 nm
Adjustment	Cable, Single teach-in button
Pin 2 configuration	External input, Teach-in input, Sender off input, Detection output, logic output, Device contamination alarm output
AutoAdapt	✓
Special feature	Detecting transparent objects
Special applications	Detecting transparent objects

¹⁾ Reflector PL80A.

²⁾ Average service life: 100,000 h at T_J = +25 °C.

Mechanics/electronics

Supply voltage U_B	10 V DC ... 30 V DC ¹⁾
Ripple	< 5 V _{pp} ²⁾
Current consumption	20 mA ³⁾
Switching output	PNP ^{4) 5)}
Output function	Complementary
Switching mode	Light/dark switching ⁴⁾
Output current $I_{max.}$	≤ 100 mA ⁶⁾
Response time	< 0.5 ms ⁷⁾
Response time Q/ on Pin 2	300 μs ... 450 μs ^{7) 8)}
Switching frequency	1,000 Hz ⁹⁾
Switching frequency Q / to pin 2	≤ 1,000 Hz ¹⁰⁾
Connection type	Male connector M12, 4-pin
Circuit protection	A ¹¹⁾ B ¹²⁾ C ¹³⁾
Protection class	III
Weight	13 g
Polarisation filter	✓
Housing material	Plastic, VISTAL®
Optics material	Plastic, PMMA
Enclosure rating	IP66 IP67 IP69K
Special feature	Detecting transparent objects
Ambient operating temperature	-40 °C ... +60 °C
Ambient temperature, storage	-40 °C ... +75 °C
UL File No.	NRKH.E181493
Repeatability Q/ on Pin 2:	150 μs ⁸⁾

¹⁾ Limit values when operated in short-circuit protected network: max. 8 A.

²⁾ May not fall below or exceed U_V tolerances.

³⁾ Without load.

⁴⁾ Q = light switching.

⁵⁾ Pin 4: This switching output must not be connected to another output.

⁶⁾ At and above T_u 50 °C, a max. load current of $I_{max.} = 50$ mA is permitted.

⁷⁾ Signal transit time with resistive load.

⁸⁾ Valid for Q \ on Pin2, if configured with software.

⁹⁾ With light/dark ratio 1:1.

¹⁰⁾ With light / dark ratio 1:1, valid for Q \ on Pin2, if configured with software.

¹¹⁾ A = V_S connections reverse-polarity protected.

¹²⁾ B = inputs and output reverse-polarity protected.

¹³⁾ C = interference suppression.

Safety-related parameters

MTTF_D	1,222 years
-------------------------	-------------

DC_{avg}	0 %
Communication interface	
Communication interface	IO-Link V1.1
Communication Interface detail	COM2 (38,4 kBaud)
Cycle time	2.3 ms
Process data length	16 Bit
Process data structure	Bit 0 = switching signal Q _{L1} Bit 1 = switching signal Q _{L2} Bit 2 ... 15 = measuring value
VendorID	26
DeviceID HEX	0x8000DF
DeviceID DEC	8388831

Smart Task

Smart Task name	Time measurement + debouncing
Logic function	Direct WINDOW
Timer function	Deactivated Switch-on delay Off delay ON and OFF delay Impulse (one shot)
Inverter	Yes
Time measurement accuracy	SIO Direct: --- ¹⁾ SIO Logic: - 0,7 ... + 0,7 ms ± 0,5 % of time measurement value ²⁾ IOL: - 0.9 ... + 0.9 ms ± 0.5% of the time measurement ³⁾
Time measurement accuracy (e.g. accuracy for time measurement value = 1 s)	SIO Direct: --- ¹⁾ SIO Logic: - 5,7 ... + 5,7 ms ²⁾ IOL: - 5,9 ... + 5,9 ms ³⁾
Resolution time measuring value	1 ms
Min. Time between two process events (switches)	SIO Direct: --- SIO Logic: 450 µs IOL: 500 µs
Debounce time max.	SIO Direct: --- SIO Logic: 30.000 ms IOL: 30.000 ms
Switching signal	Switching signal Q _{L1} Output type (dependant on the adjusted threshold) Switching signal Q _{L2} Output type (dependant on the adjusted threshold)
Measuring value	Time measurement value

¹⁾ SIO Direct: sensor operation in standard I/O mode without IO-Link communication and without using internal sensor logic or time parameters (set to "direct"/"deactivated").

²⁾ SIO Logic: Sensor operation in standard I/O mode without IO-Link communication. Sensor-internal logic or timing parameters plus Automation Functions used.

³⁾ IOL: Sensor operation with full IO-Link communication and usage of logic, timing and Automation Function parameters.

Diagnosis

Device status	Yes
Quality of teach	Yes
Quality of run	Yes, Contamination display

Classifications

ECLASS 5.0	27270902
ECLASS 5.1.4	27270902
ECLASS 6.0	27270902
ECLASS 6.2	27270902
ECLASS 7.0	27270902
ECLASS 8.0	27270902
ECLASS 8.1	27270902
ECLASS 9.0	27270902
ECLASS 10.0	27270902
ECLASS 11.0	27270902
ECLASS 12.0	27270902
ETIM 5.0	EC002717
ETIM 6.0	EC002717
ETIM 7.0	EC002717
ETIM 8.0	EC002717
UNSPSC 16.0901	39121528

Adjustments

Single teach-in button

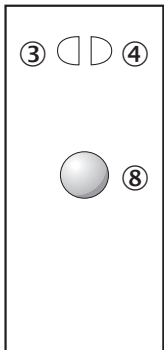

- ③ LED indicator yellow: Status of received light beam
- ④ LED indicator green: power on
- ⑧ Teach-in button

Connection type

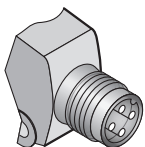

Connection diagram

Cd-367

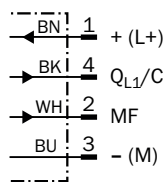

Characteristic curve

WL9G-3

Function reserve

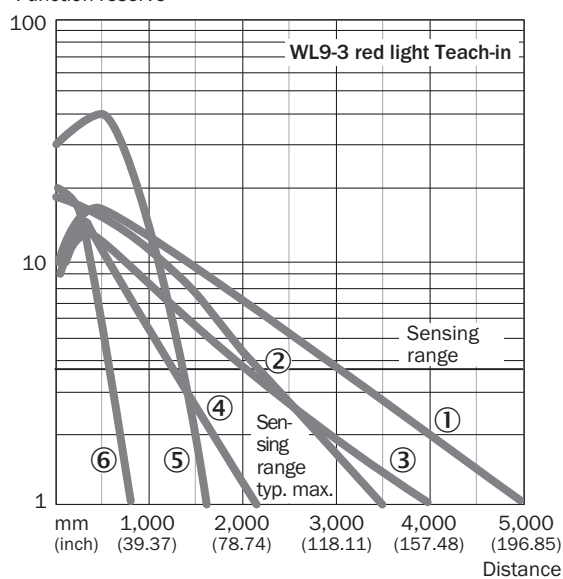

- ① Reflector PL80A
- ② Reflector P250F
- ③ Reflector PL40A
- ④ Reflector PL20F
- ⑤ PL10F reflector
- ⑥ Reflective tape REF-IRF-56

Light spot size

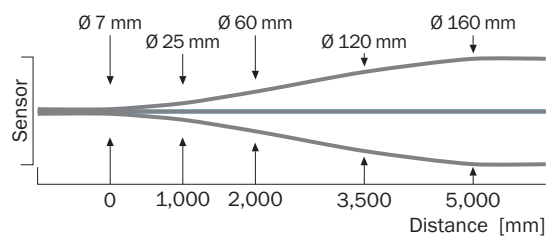

Sensing range diagram

WL9G-3

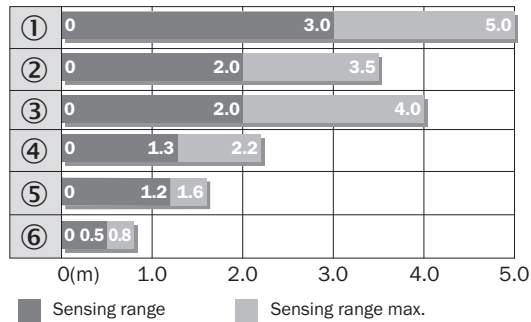

- ① Reflector PL80A
- ② Reflector P250F
- ③ Reflector PL40A
- ④ Reflector PL20F
- ⑤ PL10F reflector
- ⑥ Reflective tape REF-IRF-56

Dimensional drawing (Dimensions in mm (inch))



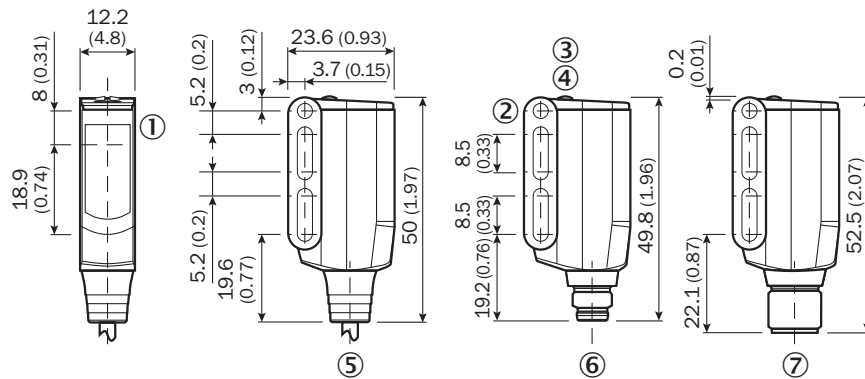

WL9-3, WSE9-3



- ① Sender and receiver optical axis center
- ② Mounting hole M3 (Ø 3.1 mm)
- ③ LED indicator yellow: Status of received light beam
- ④ LED indicator green: power on
- ⑤ Connecting cable or connector
- ⑥ Male connector M8, 4-pin
- ⑦ Male connector M12, 4-pin

Recommended accessories

Other models and accessories → www.sick.com/W9

	Brief description	Type	Part no.
Mounting brackets and plates			
	Mounting bracket, steel, zinc coated, mounting hardware included	BEF-WN-W9-2	2022855
Reflectors			
	Fine triple reflector, screw connection, suitable for laser sensors, 52 mm x 62 mm, PM-MA/ABS, Screw-on, 2 hole mounting	P250F	5308843
Others			
	<ul style="list-style-type: none"> • Connection type head A: Female connector, M12, 4-pin, straight, A-coded • Connection type head B: Flying leads • Signal type: Sensor/actuator cable • Cable: 5 m, 4-wire, PVC • Description: Sensor/actuator cable, unshielded • Application: Zones with chemicals, Uncontaminated zones 	YF2A14-050VB3XLEAX	2096235
	<ul style="list-style-type: none"> • Connection type head A: Male connector, M12, 4-pin, straight, A-coded • Description: Unshielded • Connection systems: Screw-type terminals • Permitted cross-section: ≤ 0.75 mm² 	STE-1204-G	6009932

Recommended services

Additional services → www.sick.com/W9

	Type	Part no.
Function Block Factory		
<ul style="list-style-type: none"> • Description: The Function Block Factory is an engineering tool for creating device and environment-specific function blocks that enable IO-Link sensors to be integrated into programmable logic controllers. The Function Block Factory supports common programmable logic controllers (PLCs) of various manufacturers such as Siemens, Beckhoff, Rockwell Automation B&R and more. More information on the FBF can be found here. • Provision: Customers can obtain access to the Function Block Factory and the license via https://fbf.cloud.sick.com. 	Function Block Factory	On request

SICK AT A GLANCE

SICK is one of the leading manufacturers of intelligent sensors and sensor solutions for industrial applications. A unique range of products and services creates the perfect basis for controlling processes securely and efficiently, protecting individuals from accidents and preventing damage to the environment.

We have extensive experience in a wide range of industries and understand their processes and requirements. With intelligent sensors, we can deliver exactly what our customers need. In application centers in Europe, Asia and North America, system solutions are tested and optimized in accordance with customer specifications. All this makes us a reliable supplier and development partner.

Comprehensive services complete our offering: SICK LifeTime Services provide support throughout the machine life cycle and ensure safety and productivity.

For us, that is “Sensor Intelligence.”

WORLDWIDE PRESENCE:

Contacts and other locations –www.sick.com