



# WLA16P-24161100A00

W16

SMALL PHOTOELECTRIC SENSORS

**SICK**  
Sensor Intelligence.



Illustration may differ



### Ordering information

| Type               | Part no. |
|--------------------|----------|
| WLA16P-24161100A00 | 1220993  |

Other models and accessories → [www.sick.com/W16](http://www.sick.com/W16)

### Detailed technical data

#### Features

|  |   |
|--|---|
| <b>Functional principle</b>  | Photoelectric retro-reflective sensor                               |
| <b>Functional principle detail</b>   | Without reflector minimum distance (autocollimation/coaxial optics) |
| <b>Sensing range</b>   |   |
| Sensing range min.   | 0 m   |
| Sensing range max.   | 10 m  |
| Maximum distance range from reflector to sensor (operating reserve 1)        | 0 m ... 10 m  |
| Recommended distance range from reflector to sensor (operating reserve 3,75) | 0 m ... 7 m   |
| Reference reflector  | Reflector PL80A   |
| Recommended sensing range for the best performance                           | 0 m ... 7 m   |
| <b>Polarisation filters</b>  | Yes   |
| <b>Emitted beam</b>  |   |
| Light source   | PinPoint LED  |
| Type of light  | Visible red light   |
| Shape of light spot  | Point-shaped  |
| Light spot size (distance)   | Ø 80 mm (5 m)   |

|   |  |
|---|--|
| Maximum dispersion of the emitted beam around the standardized transmission axis (squint angle) | < +/- 1.0° (at T <sub>a</sub> = +23 °C)  |
| <b>Key LED figures</b>  |  |
| Normative reference   | EN 62471:2008-09   IEC 62471:2006, modified  |
| LED risk group marking  | Free group   |
| Wave length   | 635 nm   |
| Average service life  | 100,000 h at T <sub>a</sub> = +25 °C   |
| <b>Adjustment</b>   |  |
| IO-Link   | For configuring the sensor parameters and Smart Task functions   |
| <b>Indication</b>   |  |
| LED blue  | BluePilot: Alignment aid   |
| LED green   | Operating indicator<br>Static on: power on<br>Flashing: IO-Link mode   |
| LED yellow  | Status of received light beam<br>Static on: object not present<br>Static off: object present<br>Flashing: Below the 1.5 function reserve |
| <b>Special applications</b>   | Detecting objects wrapped in film  |

### Safety-related parameters

|                                     |  |
|-------------------------------------|--|
| <b>MTTF<sub>D</sub></b>             | 690 years                                  |
| <b>DC<sub>avg</sub></b>             | 0%   |
| <b>T<sub>M</sub> (mission time)</b> | 20 years (EN ISO 13849, rate of use: 60 %) |

### Communication interface

|                             |  |
|-----------------------------|--|
| <b>IO-Link</b>              | ✓, V1.1  |
| Data transmission rate      | COM2 (38,4 kBaud)  |
| Cycle time                  | 2.3 ms   |
| Process data length         | 16 Bit   |
| Process data structure      | Bit 0 = switching signal Q <sub>L1</sub><br>Bit 1 = switching signal Q <sub>L2</sub><br>Bit 2 ... 15 = empty |
| VendorID                    | 26   |
| DeviceID HEX                | 0x80016C   |
| DeviceID DEC                | 8388972  |
| Compatible master port type | A  |
| SIO mode support            | Yes  |

### Electrical data

|                                     |  |
|-------------------------------------|--|
| <b>Supply voltage U<sub>B</sub></b> | 10 V DC ... 30 V DC <sup>1)</sup>                                      |
| <b>Ripple</b>                       | ≤ 5 V <sub>pp</sub>  |
| <b>Usage category</b>               | DC-12 (According to EN 60947-5-2)<br>DC-13 (According to EN 60947-5-2) |

<sup>1)</sup> Limit values.

<sup>2)</sup> Signal transit time with resistive load in switching mode.

<sup>3)</sup> With light/dark ratio 1:1.

<sup>4)</sup> This switching output must not be connected to another output.

|                                       |  |
|---------------------------------------|--|
| <b>Current consumption</b>            | ≤ 30 mA, without load. At $U_B = 24\text{ V}$  |
| <b>Protection class</b>               | III  |
| <b>Digital output</b>                 |  |
| Number                                | 2 (Complementary)  |
| Type                                  | Push-pull: PNP/NPN   |
| Switching mode                        | Light/dark switching   |
| Signal voltage PNP HIGH/LOW           | Approx. $U_B - 2.5\text{ V} / 0\text{ V}$  |
| Signal voltage NPN HIGH/LOW           | Approx. $U_B / < 2.5\text{ V}$   |
| Output current $I_{\text{max}}$       | ≤ 100 mA   |
| Circuit protection outputs            | Reverse polarity protected<br>Overcurrent and short-circuit protected  |
| Response time                         | ≤ 500 $\mu\text{s}$ <sup>2)</sup>  |
| Repeatability (response time)         | 150 $\mu\text{s}$  |
| Switching frequency                   | 1,000 Hz <sup>3)</sup>   |
| <b>Pin/Wire assignment</b>            |  |
| Function of pin 4/black (BK)          | Digital output, dark switching, object present → output $\bar{Q}_{L1}$ HIGH; IO-Link communication C <sup>4)</sup> |
| Function of pin 4/black (BK) – detail | The pin 4 function of the sensor can be configured, Additional possible settings via IO-Link                       |
| Function of pin 2/white (WH)          | Digital output, light switching, object present → output $Q_{L1}$ LOW <sup>4)</sup>                                |
| Function of pin 2/white (WH) – detail | The pin 2 function of the sensor can be configured, Additional possible settings via IO-Link                       |

<sup>1)</sup> Limit values.

<sup>2)</sup> Signal transit time with resistive load in switching mode.

<sup>3)</sup> With light/dark ratio 1:1.

<sup>4)</sup> This switching output must not be connected to another output.

### Mechanical data

|   |                           |
|---|---------------------------|
| <b>Housing</b>  | Rectangular               |
| <b>Dimensions (W x H x D)</b>                         | 20 mm x 55.7 mm x 42 mm   |
| <b>Connection</b>                                     | Male connector M12, 4-pin |
| <b>Material</b>                                       |                           |
| Housing   | Plastic, VISTAL®          |
| Front screen  | Plastic, PMMA             |
| Male connector  | Plastic, VISTAL®          |
| <b>Weight</b>   | Approx. 50 g              |
| <b>Maximum tightening torque of the fixing screws</b> | 1.3 Nm                    |

### Ambient data

|                                      |   |
|--------------------------------------|---|
| <b>Enclosure rating</b>              | IP66 (EN 60529)<br>IP67 (EN 60529)<br>IP69 (EN 60529) <sup>1)</sup>   |
| <b>Ambient operating temperature</b> | -40 °C ... +60 °C   |
| <b>Ambient temperature, storage</b>  | -40 °C ... +75 °C   |
| <b>Shock resistance</b>              | 50 g, 11 ms (25 positive and 25 negative shocks per axis, for X, Y, Z axes, 150 shocks in total (EN60068-2-27)) |

<sup>1)</sup> Replaces IP69K with ISO 20653: 2013-03.

|  |   |
|--|---|
|  | 50 g, 6 ms (5,000 positive and 5,000 negative shocks per axis, for X, Y, Z axes, 30,000 shocks in total (EN60068-2-27)) |
| <b>Vibration resistance</b>                | 10 Hz ... 2,000 Hz (Amplitude 0.5 mm / 10 g, 20 sweeps per axis, for X, Y, Z axes, 1 octave/min, (EN60068-2-6))         |
| <b>Air humidity</b>                        | 35 % ... 95 %, relative humidity (no condensation)  |
| <b>Electromagnetic compatibility (EMC)</b> | EN 60947-5-2  |
| <b>Resistance to cleaning agent</b>        | ECOLAB  |
| <b>UL File No.</b>                         | NRKH.E181493 & NRKH7.E181493  |

<sup>1)</sup> Replaces IP69K with ISO 20653: 2013-03.

## Smart Task

|                                 |   |
|---------------------------------|---|
| <b>Smart Task name</b>          | Base logics   |
| <b>Logic function</b>           | Direct<br>AND<br>OR<br>Window<br>Hysteresis   |
| <b>Timer function</b>           | Deactivated<br>Switch-on delay<br>Off delay<br>ON and OFF delay<br>Impulse (one shot) |
| <b>Inverter</b>                 | Yes   |
| <b>Switching frequency</b>      | SIO Logic: 800 Hz <sup>1)</sup><br>IOL: 650 Hz <sup>2)</sup>                          |
| <b>Response time</b>            | SIO Logic: 600 µs <sup>1)</sup><br>IOL: 750 µs <sup>2)</sup>                          |
| <b>Repeatability</b>            | SIO Logic: 300 µs <sup>1)</sup><br>IOL: 750 µs <sup>2)</sup>                          |
| <b>Switching signal</b>         |   |
| Switching signal $Q_{L1}$       | Switching output  |
| Switching signal $\bar{Q}_{L1}$ | Switching output  |

<sup>1)</sup> Use of Smart Task functions without IO-Link communication (SIO mode).

<sup>2)</sup> Use of Smart Task functions with IO-Link communication function.

## Diagnosis

|                         |                            |
|-------------------------|----------------------------|
| <b>Device status</b>    | Yes                        |
| <b>Quality of teach</b> | Yes                        |
| <b>Quality of run</b>   | Yes, Contamination display |

## Classifications

|                     |          |
|---------------------|----------|
| <b>ECLASS 5.0</b>   | 27270902 |
| <b>ECLASS 5.1.4</b> | 27270902 |
| <b>ECLASS 6.0</b>   | 27270902 |
| <b>ECLASS 6.2</b>   | 27270902 |
| <b>ECLASS 7.0</b>   | 27270902 |
| <b>ECLASS 8.0</b>   | 27270902 |
| <b>ECLASS 8.1</b>   | 27270902 |

|                       |          |
|-----------------------|----------|
| <b>ECLASS 9.0</b>     | 27270902 |
| <b>ECLASS 10.0</b>    | 27270902 |
| <b>ECLASS 11.0</b>    | 27270902 |
| <b>ECLASS 12.0</b>    | 27270902 |
| <b>ETIM 5.0</b>       | EC002717 |
| <b>ETIM 6.0</b>       | EC002717 |
| <b>ETIM 7.0</b>       | EC002717 |
| <b>ETIM 8.0</b>       | EC002717 |
| <b>UNSPSC 16.0901</b> | 39121528 |

### Dimensional drawing (Dimensions in mm (inch))

Dimensional drawing, sensor

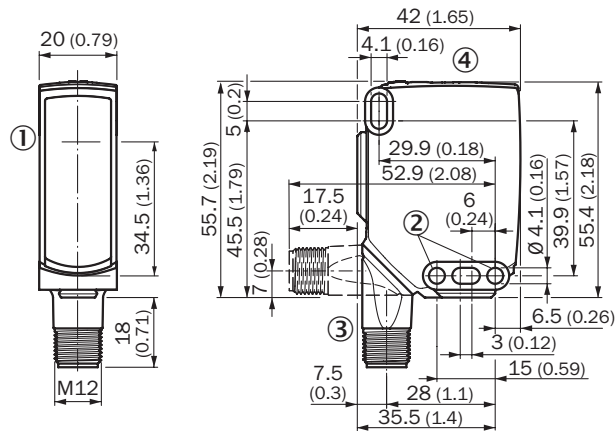

- ① Center of optical axis
- ② Mounting hole,  $\varnothing$  4.1 mm
- ③ Connection
- ④ Display and adjustment elements

### Adjustments

Display and adjustment elements

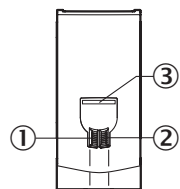

- ① LED indicator green
- ② LED indicator yellow
- ③ LED blue

Connection type

M12 male connector, 4-pin

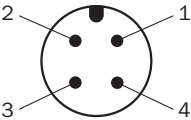

Connection diagram

Cd-390



Truth table

Push-pull: PNP/NPN - light switching Q

|                         | Light switching Q (normally closed (upper switch), normally open (lower switch)) |                             |
|-------------------------|--|-----------------------------|
|                         | Object not present → Output HIGH   | Object present → Output LOW |
| Light receive           | ✓  | ✗                           |
| Light receive indicator | ☀  | ✗                           |
| Load resistance to L+   | ✗  | ⚠                           |
| Load resistance to M    | ⚠  | ✗                           |
|                         |  |                             |

Push-pull: PNP/NPN – dark switching  $\bar{Q}$

|                         | Dark switching $\bar{Q}$ (normally open (upper switch), normally closed (lower switch)) |                              |
|-------------------------|---|------------------------------|
|                         | Object not present → Output LOW   | Object present → Output HIGH |
| Light receive           | ✓   | ✗                            |
| Light receive indicator | ☀   | ✗                            |
| Load resistance to L+   | ⚠   | ✗                            |
| Load resistance to M    | ✗   | ⚠                            |
|                         |   |                              |

### Characteristic curve

Reflective tape

Operating reserve

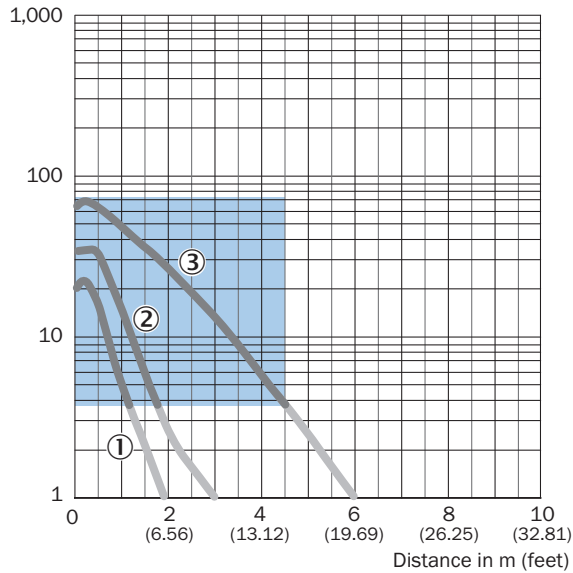

Recommended sensing range for the best performance

- ① Reflective tape REF-DG (50 x 50 mm)
- ② Reflective tape REF-IRF-56 (50 x 50 mm)
- ③ Reflective tape REF-AC1000 (50 x 50 mm)

Standard reflectors

Operating reserve

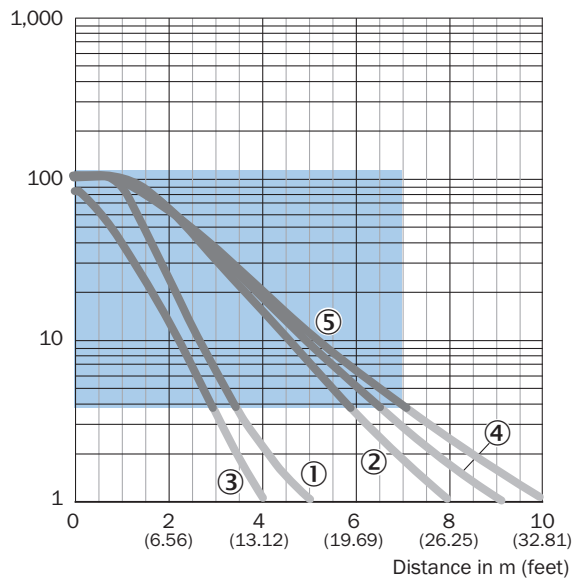

Recommended sensing range for the best performance

- ① Reflector PL22
- ② Reflector P250, PL30A
- ③ Reflector PL20A
- ④ Reflector PL40A
- ⑤ Reflector PL80A, C110A



**Fine triple reflectors**

Operating reserve

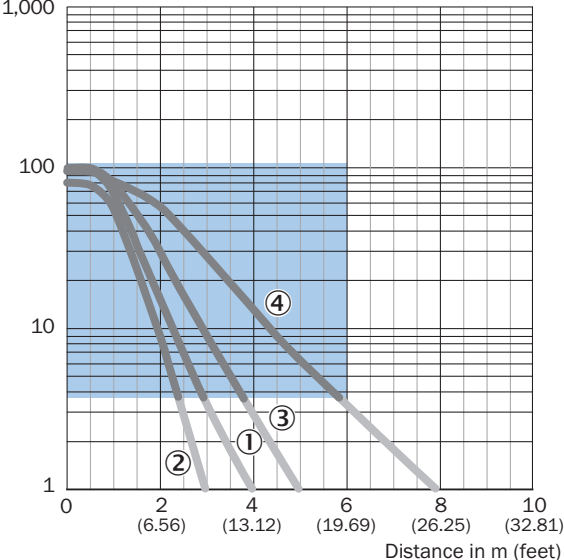

- Recommended sensing range for the best performance
- ① PL10FH-1 reflector
- ② PL10F reflector
- ③ Reflector PL20F
- ④ Reflector P250F

**Chemical-resistant reflectors**

Operating reserve

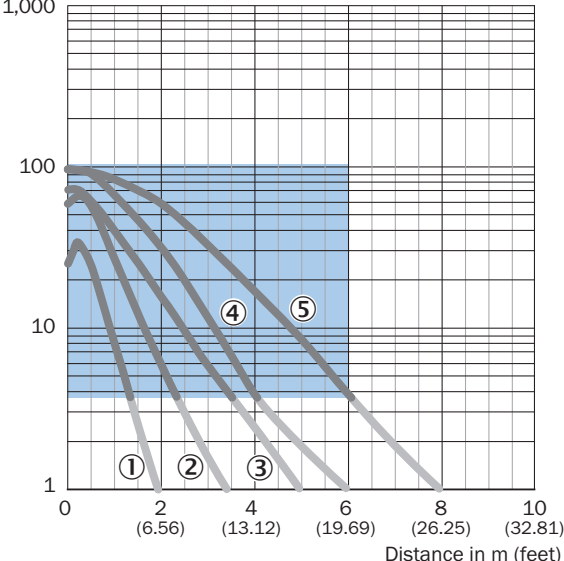

- Recommended sensing range for the best performance
- ① PL10F CHEM reflector
- ② Reflector PL20 CHEM
- ③ Reflector P250 CHEM
- ④ Reflector P250H
- ⑤ Reflector PL40A Antifog

### Light spot size

WLA16P-xxxxx1xx

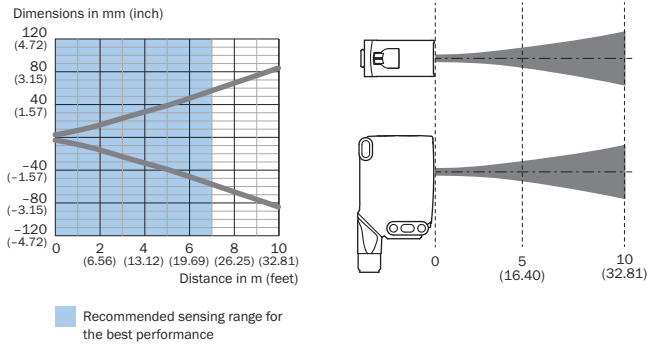

### Sensing range diagram

Reflective tape

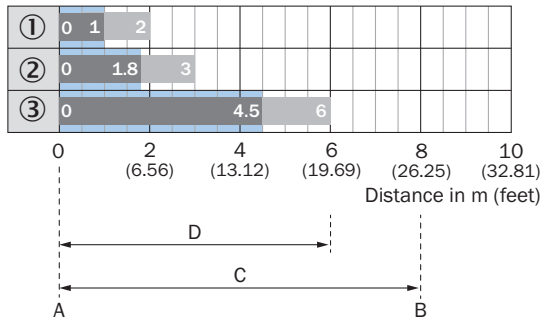

Recommended sensing range for the best performance

WLA16P-xxxxx1xx

|   |  |
|---|--|
| 1 | Reflective tape REF-DG (50 x 50 mm)  |
| 2 | Reflective tape REF-IRF-56 (50 x 50 mm)                                      |
| 3 | Reflective tape REF-AC1000 (50 x 50 mm)                                      |
| A | Sensing range min. in m  |
| B | Sensing range max. in m  |
| C | Maximum distance range from reflector to sensor (operating reserve 1)        |
| D | Recommended distance range from reflector to sensor (operating reserve 3,75) |

Standard reflectors

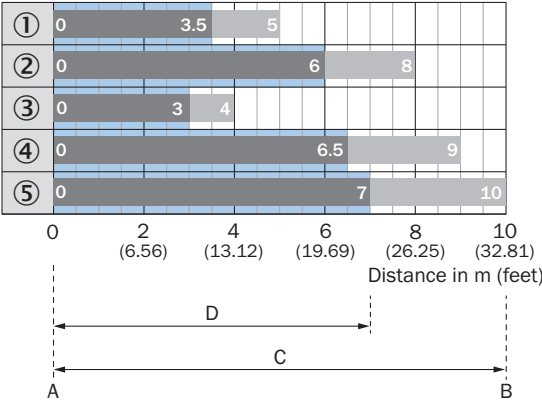

Recommended sensing range for the best performance  
WLA16P-xxxx1xx

|   |  |
|---|--|
| 1 | Reflector PL22   |
| 2 | Reflector P250, PL30A  |
| 3 | Reflector PL20A  |
| 4 | Reflector PL40A  |
| 5 | Reflector PL80A, C110A   |
| A | Sensing range min. in m  |
| B | Sensing range max. in m  |
| C | Maximum distance range from reflector to sensor (operating reserve 1)        |
| D | Recommended distance range from reflector to sensor (operating reserve 3,75) |

Fine triple reflectors

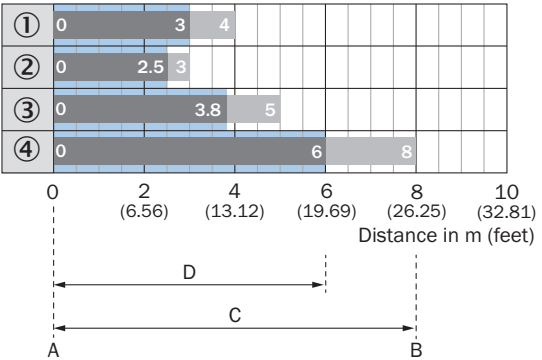

Recommended sensing range for the best performance  
WLA16P-xxxx1xx

|   |                         |
|---|-------------------------|
| 1 | PL10FH-1 reflector      |
| 2 | PL10F reflector         |
| 3 | Reflector PL20F         |
| 4 | Reflector P250F         |
| A | Sensing range min. in m |
| B | Sensing range max. in m |

|   |  |
|---|--|
| C | Maximum distance range from reflector to sensor (operating reserve 1)        |
| D | Recommended distance range from reflector to sensor (operating reserve 3,75) |

### Chemical-resistant reflectors

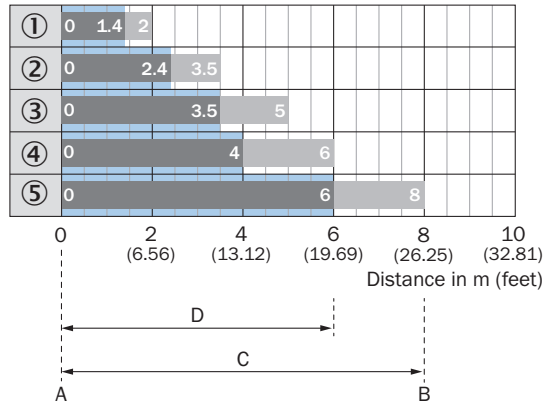

Recommended sensing range for the best performance

### WLA16P-xxxx1xx

|   |  |
|---|--|
| 1 | PL10F CHEM reflector   |
| 2 | Reflector PL20 CHEM  |
| 3 | Reflector P250 CHEM  |
| 4 | Reflector P250H  |
| 5 | Reflector PL40A Antifog  |
| A | Sensing range min. in m  |
| B | Sensing range max. in m  |
| C | Maximum distance range from reflector to sensor (operating reserve 1)        |
| D | Recommended distance range from reflector to sensor (operating reserve 3,75) |

## Functions

### Operation note

#### BluePilot: Blue indicator LEDs with double benefits

|   |  |
|---|--|
| <p>Easy and quick sensor alignment with the help of the LED indicator</p> <ul style="list-style-type: none"> <li>All blue LEDs illuminate</li> <li>- optimum alignment</li> <li>- highest possible operating reserve</li> </ul>   | <p>WLA photoelectric retro-reflection sensor alignment</p> |
| <p><b>Service note</b></p> <p>A reduction in sensor availability is displayed by a decrease of the blue LEDs.</p> <p>Possible causes:</p> <ul style="list-style-type: none"> <li>a) insufficient alignment</li> <li>b) contamination of the optical surfaces</li> <li>c) particles in the light beam</li> </ul> |  |

Operation note

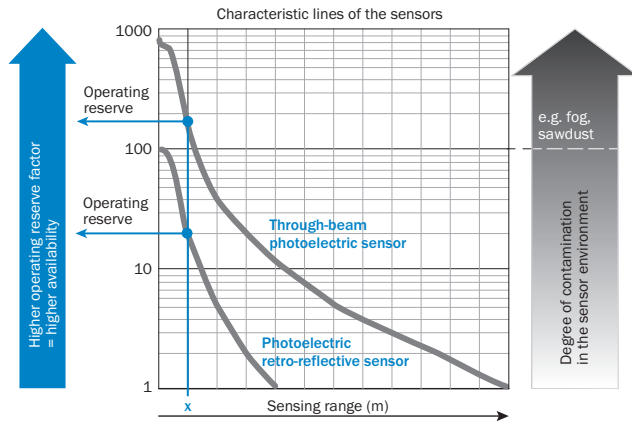

At a sensing range of „x“ the photoelectric retro-reflective and through-beam photoelectric sensors have different operating reserves (see blue arrow). The higher the operating reserve factor, the better the sensor can compensate the contamination in the air or in the light beam and on the optical surfaces (front screen, reflector), i.e. the sensor has the maximum availability, otherwise the sensor switches due to pollution although there is no object in the path of the light beam.

Recommended accessories

Other models and accessories → [www.sick.com/W16](http://www.sick.com/W16)

|                                     | Brief description   | Type               | Part no. |
|-------------------------------------|---|--------------------|----------|
| <b>Universal bar clamp systems</b>  |   |                    |          |
|                                     | Plate N02 for universal clamp bracket, Zinc plated steel (sheet), Zinc die cast (clamping bracket), Universal clamp (5322626), mounting hardware  | BEF-KHS-N02        | 2051608  |
| <b>Mounting brackets and plates</b> |   |                    |          |
|                                     | Universal mounting bracket for reflectors, steel, zinc coated   | BEF-WN-REFX        | 2064574  |
|                                     | Adapter for mounting W16 sensors in existing W14-2/W18-3 installations or L25 sensors in existing L28 installations, plastic, fastening screws included   | BEF-AP-W16         | 2095677  |
| <b>Reflectors</b>                   |   |                    |          |
|                                     | Rectangular, screw connection, 84 mm x 84 mm, PMMA/ABS, Screw-on, 2 hole mounting   | PL80A              | 1003865  |
| <b>Others</b>                       |   |                    |          |
|                                     | <ul style="list-style-type: none"> <li>• <b>Connection type head A:</b> Female connector, M12, 4-pin, straight, A-coded</li> <li>• <b>Connection type head B:</b> Flying leads</li> <li>• <b>Signal type:</b> Sensor/actuator cable</li> <li>• <b>Cable:</b> 5 m, 4-wire, PVC</li> <li>• <b>Description:</b> Sensor/actuator cable, unshielded</li> <li>• <b>Application:</b> Zones with chemicals</li> </ul> | YF2A14-050VB3XLEAX | 2096235  |

### Recommended services

Additional services → [www.sick.com/W16](http://www.sick.com/W16)

|   | Type                   | Part no.   |
|---|------------------------|------------|
| Function Block Factory  |                        |            |
| <ul style="list-style-type: none"><li>• <b>Description:</b> The Function Block Factory supports common programmable logic controllers (PLCs) from various manufacturers, such as Siemens, Beckhoff, Rockwell Automation and B&amp;R. More information on the FBF can be found <a _blank"="" href="https://fbf.cloud.sick.com target=">here</a>.</li><li>• <b>Note:</b> You can configure your function block at <a _blank"="" href="https://fbf.cloud.sick.com target=">Function Block Factory</a>. As a login please use your SICK ID.</li></ul> | Function Block Factory | On request |

## SICK AT A GLANCE

SICK is one of the leading manufacturers of intelligent sensors and sensor solutions for industrial applications. A unique range of products and services creates the perfect basis for controlling processes securely and efficiently, protecting individuals from accidents and preventing damage to the environment.

We have extensive experience in a wide range of industries and understand their processes and requirements. With intelligent sensors, we can deliver exactly what our customers need. In application centers in Europe, Asia and North America, system solutions are tested and optimized in accordance with customer specifications. All this makes us a reliable supplier and development partner.

Comprehensive services complete our offering: SICK LifeTime Services provide support throughout the machine life cycle and ensure safety and productivity.

For us, that is “Sensor Intelligence.”

## WORLDWIDE PRESENCE:

Contacts and other locations –[www.sick.com](http://www.sick.com)