



WLD4FP-841121A0ZZZ

W4

MINIATURE PHOTOELECTRIC SENSORS

SICK
Sensor Intelligence.



Illustration may differ

Ordering information

Type	Part no.
WLD4FP-841121A0ZZZ	1123746

Other models and accessories → www.sick.com/W4



Detailed technical data

Features

Functional principle	Photoelectric retro-reflective sensor
Functional principle detail	With minimum distance to reflector (dual lens system)
Sensing range	
Sensing range min.	0 m
Sensing range max.	4.5 m
Maximum distance range from reflector to sensor (operating reserve 1)	0.015 m ... 4.5 m
Recommended distance range from reflector to sensor (operating reserve 3,75)	0.035 m ... 3.9 m
Reference reflector	Reflector P250
Recommended sensing range for the best performance	0.035 m ... 3.9 m
Polarisation filters	Yes
Emitted beam	
Light source	PinPoint LED
Type of light	Visible red light
Shape of light spot	Point-shaped
Light spot size (distance)	Ø 38 mm (1,000 mm)
Maximum dispersion of the emitted beam around the standardized transmission axis (squint angle)	< +/- 1.5° (at Ta = +23 °C)
Key LED figures	

Normative reference	EN 62471:2008-09 IEC 62471:2006, modified	
LED risk group marking	Free group	
Wave length	635 nm	
Average service life	100,000 h at $T_a = +25\text{ °C}$	
Adjustment		
	None	-
Indication		
	LED green	Operating indicator Static on: power on
	LED yellow	Status of received light beam Static on: object not present Static off: object present Flashing: Below the 1.5 function reserve

Safety-related parameters

MTTF_D	1,390 years
DC_{avg}	0 %
T_M (mission time)	20 years (EN ISO 13849, rate of use: 60 %)

Electrical data

Supply voltage U_B	10 V DC ... 30 V DC ¹⁾	
Ripple	≤ 5 V _{pp}	
Usage category	DC-12 (According to EN 60947-5-2) DC-13 (According to EN 60947-5-2)	
Current consumption	≤ 20 mA, without load. At U _B = 24 V	
Protection class	III	
Digital output		
	Number	2 (Complementary)
	Type	Push-pull: PNP/NPN
	Switching mode	Light/dark switching
	Signal voltage PNP HIGH/LOW	Approx. U _B -2.5 V / 0 V
	Signal voltage NPN HIGH/LOW	Approx. U _B / < 2.5 V
	Output current I _{max}	≤ 100 mA
	Circuit protection outputs	Reverse polarity protected Overcurrent protected Short-circuit protected
	Response time	≤ 500 μs ²⁾
	Repeatability (response time)	150 μs
	Switching frequency	1,000 Hz ³⁾
Pin/Wire assignment		
	Function of pin 4/black (BK)	Digital output, light switching, object present → output Q LOW ⁴⁾
	Function of pin 2/white (WH)	Digital output, dark switching, object present → output \bar{Q}_{L1} HIGH ⁴⁾

¹⁾ Limit values.

²⁾ Signal transit time with resistive load in switching mode.

³⁾ With light/dark ratio 1:1.

⁴⁾ This switching output must not be connected to another output.

Mechanical data

Housing	Rectangular
Design detail	Flat
Dimensions (W x H x D)	16 mm x 40.1 mm x 12.1 mm
Connection	Cable with M12 male connector, 4-pin, 182 mm
Connection detail	
Deep-freeze property	Do not bend below 0 °C
Conductor size	0.14 mm ²
Cable diameter	Ø 3.4 mm
Length of cable (L)	140 mm
Material	
Housing	Plastic, VISTAL®
Front screen	Plastic, PMMA
Cable	Plastic, PVC
Male connector	Plastic, VISTAL®
Weight	Approx. 30 g
Maximum tightening torque of the fixing screws	0.4 Nm

Ambient data

Enclosure rating	IP66 (EN 60529) IP67 (EN 60529) IP69 (EN 60529)
Ambient operating temperature	-40 °C ... +60 °C
Ambient temperature, storage	-40 °C ... +75 °C
Typ. Ambient light immunity	Artificial light: ≤ 50,000 lx Sunlight: ≤ 50,000 lx
Shock resistance	30 g, 11 ms (3 positive and 3 negative shocks along X, Y, Z axes, 18 total shocks (EN60068-2-27))
Vibration resistance	10 Hz ... 1,000 Hz (Amplitude 1 mm, 3 x 30 min (EN60068-2-6))
Air humidity	35 % ... 95 %, relative humidity (no condensation)
Electromagnetic compatibility (EMC)	EN 60947-5-2
Resistance to cleaning agent	ECOLAB
UL File No.	NRKH.E181493 & NRKH7.E181493

Classifications

ECLASS 5.0	27270902
ECLASS 5.1.4	27270902
ECLASS 6.0	27270902
ECLASS 6.2	27270902
ECLASS 7.0	27270902
ECLASS 8.0	27270902
ECLASS 8.1	27270902
ECLASS 9.0	27270902
ECLASS 10.0	27270902

ECLASS 11.0	27270902
ECLASS 12.0	27270904
ETIM 5.0	EC002717
ETIM 6.0	EC002717
ETIM 7.0	EC002717
ETIM 8.0	EC002717
UNSPSC 16.0901	39121528

Connection type

M12 male connector, 4-pin

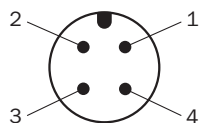

Connection diagram

Cd-083

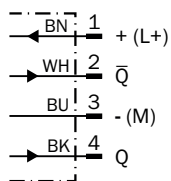

Truth table

Push-pull: PNP/NPN - light switching Q

	Light switching Q (normally closed (upper switch), normally open (lower switch))	
	Object not present → Output HIGH	Object present → Output LOW
Light receive	✔	✘
Light receive indicator	☉	✘
Load resistance to L+	✘	⚠
Load resistance to M	⚠	✘

Push-pull: PNP/NPN – dark switching \bar{Q}

	Dark switching \bar{Q} (normally open (upper switch), normally closed (lower switch))	
	Object not present → Output LOW	Object present → Output HIGH
Light receive	✓	✗
Light receive indicator	☉	✗
Load resistance to L+	⚠	✗
Load resistance to M	✗	⚠

Characteristic curve

Reflective tape

Operating reserve

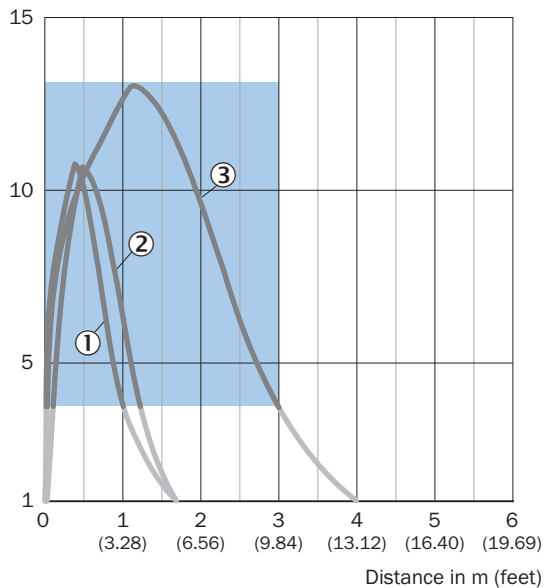

Recommended sensing range for the best performance

- ① Reflective tape REF-DG
- ② Reflective tape REF-IRF-56
- ③ Reflective tape REF-AC1000

Standard reflectors

Operating reserve

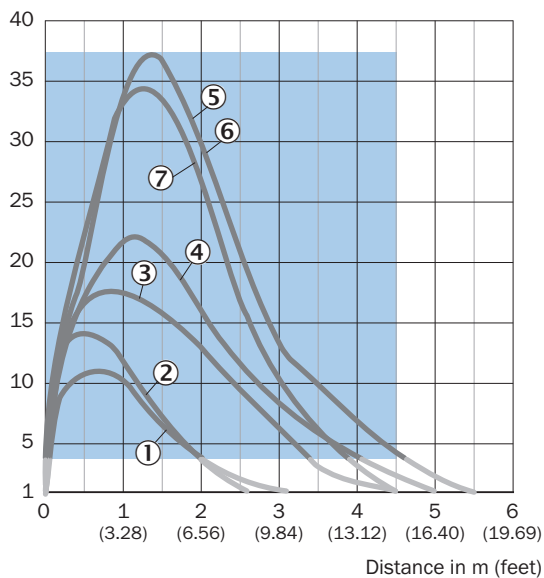

Recommended sensing range for the best performance

- ① Reflector PL22
- ② Reflector PL20A
- ③ Reflector PL30A
- ④ Reflector PL40A
- ⑤ Reflector PL80A
- ⑥ Reflector C110A
- ⑦ Reflector P250

Fine triple reflectors

Operating reserve

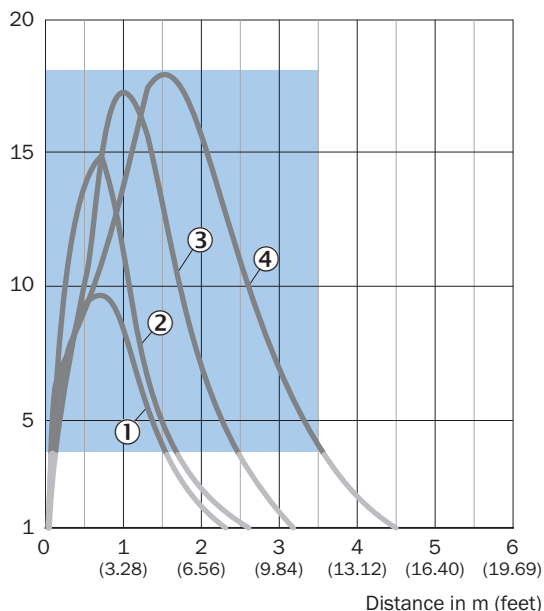

- Recommended sensing range for the best performance
- ① PL10FH reflector
- ② PL10F reflector
- ③ Reflector PL20F
- ④ Reflector P250F

Chemical-resistant reflectors

Operating reserve

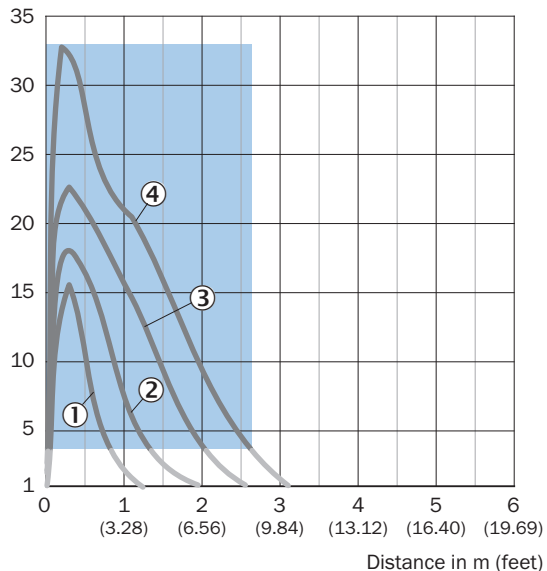

- Recommended sensing range for the best performance
- ① PL10F CHEM reflector
- ② Reflector PL20 CHEM
- ③ Reflector P250 CHEM
- ④ Reflector P250H

Light spot size

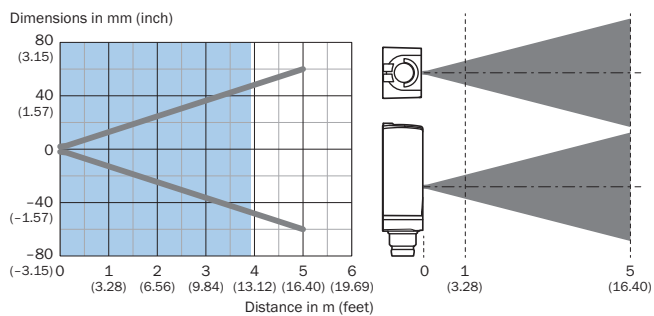

Recommended sensing range for the best performance

Sensing range diagram

Standard reflectors

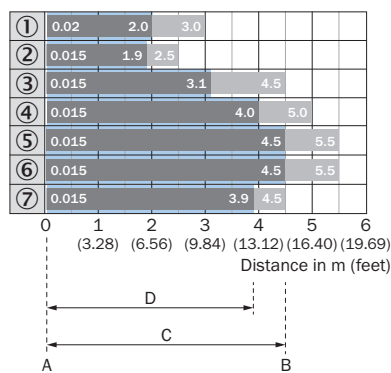

A = Sensing range min. in m

B = Sensing range max. in m

C = Maximum distance range from reflector to sensor (operating reserve 1)

D = Recommended distance range from reflector to sensor (operating reserve 3.75)

Recommended sensing range for the best performance

- ① Reflector PL22
- ② Reflector PL20A
- ③ Reflector PL30A
- ④ Reflector PL40A
- ⑤ Reflector PL80A
- ⑥ Reflector C110A
- ⑦ Reflector P250

Reflective tape

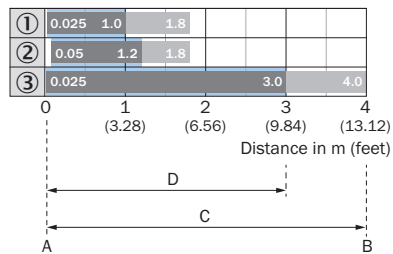

A = Sensing range min. in m
 B = Sensing range max. in m
 C = Maximum distance range from reflector to sensor (operating reserve 1)
 D = Recommended distance range from reflector to sensor (operating reserve 3.75)

Recommended sensing range for the best performance

- ① Reflective tape REF-DG (50 x 50 mm)
- ② Reflective tape REF-IRF-56
- ③ Reflective tape REF-AC1000

Fine triple reflectors

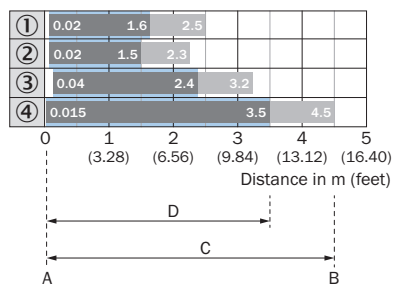

A = Sensing range min. in m
 B = Sensing range max. in m
 C = Maximum distance range from reflector to sensor (operating reserve 1)
 D = Recommended distance range from reflector to sensor (operating reserve 3.75)

Recommended sensing range for the best performance

- ① PL10FH reflector
- ② PL10F reflector
- ③ Reflector PL20F
- ④ Reflector P250F

Chemical-resistant reflectors

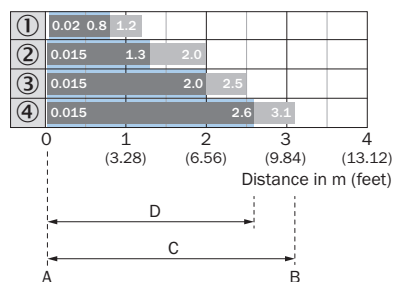

A = Sensing range min. in m
 B = Sensing range max. in m
 C = Maximum distance range from reflector to sensor (operating reserve 1)
 D = Recommended distance range from reflector to sensor (operating reserve 3.75)

Recommended sensing range for the best performance

- ① PL10F CHEM reflector
- ② Reflector PL20 CHEM
- ③ Reflector P250 CHEM
- ④ Reflector P250H

Dimensional drawing (Dimensions in mm (inch))

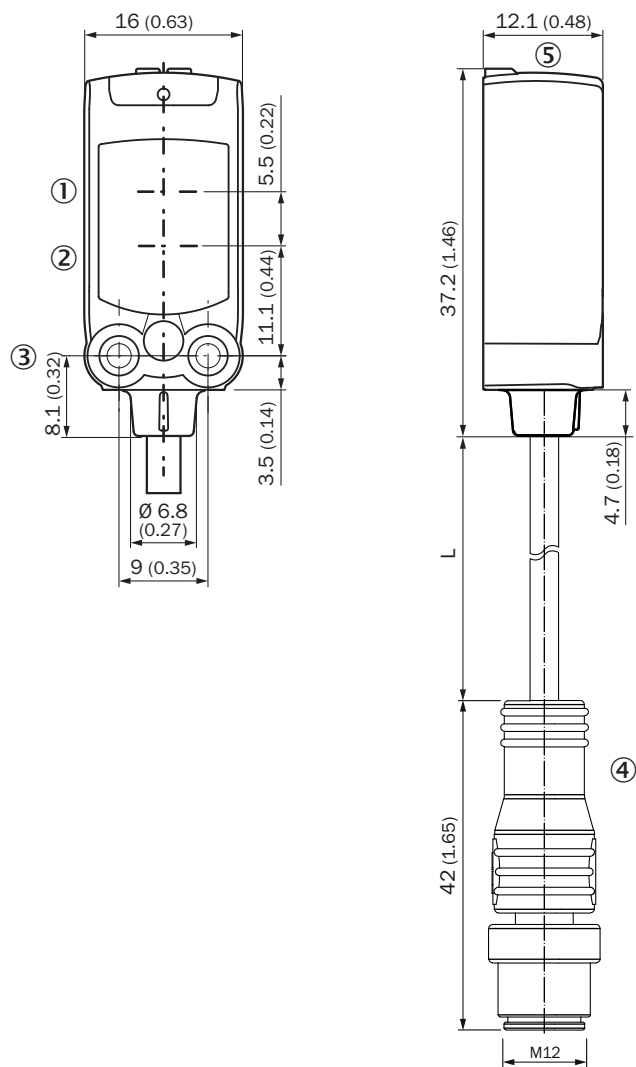





For length of cable (L), see technical data

- ① Center of optical axis, sender
- ② Center of optical axis, receiver
- ③ M3 mounting hole
- ④ Cable with M12 male connector
- ⑤ Display and adjustment elements

Recommended accessories

Other models and accessories → www.sick.com/W4

	Brief description	Type	Part no.
Mounting brackets and plates			
	Mounting bracket for wall mounting, Stainless steel 1.4571, mounting hardware included	BEF-W4-A	2051628

	Brief description	Type	Part no.
Reflectors			
	Fine triple reflector, screw connection, suitable for laser sensors, 20 mm x 32 mm, PM-MA/ABS, Screw-on, 2 hole mounting	PL10F	5311210
Others			
	<ul style="list-style-type: none"> • Connection type head A: Female connector, M12, 4-pin, straight, A-coded • Connection type head B: Flying leads • Signal type: Sensor/actuator cable • Cable: 5 m, 4-wire, PVC • Description: Sensor/actuator cable, unshielded • Application: Zones with chemicals 	YF2A14-050VB3XLEAX	2096235
	<ul style="list-style-type: none"> • Connection type head A: Male connector, M12, 4-pin, straight, A-coded • Description: Unshielded • Connection systems: Screw-type terminals • Permitted cross-section: ≤ 0.75 mm² 	STE-1204-G	6009932

SICK AT A GLANCE

SICK is one of the leading manufacturers of intelligent sensors and sensor solutions for industrial applications. A unique range of products and services creates the perfect basis for controlling processes securely and efficiently, protecting individuals from accidents and preventing damage to the environment.

We have extensive experience in a wide range of industries and understand their processes and requirements. With intelligent sensors, we can deliver exactly what our customers need. In application centers in Europe, Asia and North America, system solutions are tested and optimized in accordance with customer specifications. All this makes us a reliable supplier and development partner.

Comprehensive services complete our offering: SICK LifeTime Services provide support throughout the machine life cycle and ensure safety and productivity.

For us, that is “Sensor Intelligence.”

WORLDWIDE PRESENCE:

Contacts and other locations –www.sick.com