



WLT280L-2N1536

WTT280 PowerProx

TIME-OF-FLIGHT SENSORS

SICK
Sensor Intelligence.



Ordering information

Type	Part no.
WLT280L-2N1536	6048072

Included in delivery: P250 (1), BEF-W280 (1)

Other models and accessories → www.sick.com/WTT280_PowerProx

Illustration may differ



Detailed technical data

Features

Functional principle	Photoelectric proximity sensor
Functional principle detail	Background suppression, Optical time-of-flight
Housing design (light emission)	Rectangular
Sensing range max.	200 mm ... 18,000 mm ¹⁾ 200 mm ... 18,000 mm ¹⁾
Sensing range	200 mm ... 18,000 mm ²⁾
Type of light	Visible red light
Light source	Laser ³⁾
Light spot size (distance)	Ø 50 mm (18 m)
Laser class	1 (EN 60825-1:2014, IEC 60825-1:2014)
Adjustment	Potentiometer (2 x)
Special applications	Detecting small objects
Items supplied	Mounting bracket BEF-W280, Reflector P250
Safety-related parameters	
	MTTF _D 194 years
	DC _{avg} 0 %

¹⁾ Reflector P250.

²⁾ Einstellbar.

³⁾ Average service life: 100,000 h at T_U = +25 °C.

Electronics

Supply voltage U_B	10 V DC ... 30 V DC ¹⁾
Ripple	< 3 V _{pp}
Current consumption	70 mA ²⁾
Switching output	NPN
Number of switching outputs	2 (Q ₁ , Q ₂) ³⁾
Switching mode	Light/dark switching
Switching mode selector	Selectable via light/dark rotary switch
Output current I_{max}	≤ 100 mA
Response time	≤ 0.5 ms ⁴⁾
Switching frequency	+ 1,000 Hz ⁵⁾
Analog output	-
Input	Sender off
Circuit protection	A ⁶⁾ B ⁷⁾ C ⁸⁾ D ⁹⁾
Protection class	III
Enclosure rating	IP67

¹⁾ Limit values. Operated in short-circuit protected network: max. 8 A.

²⁾ Without load.

³⁾ Q₁, Q₂ = 2 switching thresholds, light/dark switching selectable via light/dark selector.

⁴⁾ Signal transit time with resistive load.

⁵⁾ With light/dark ratio 1:1.

⁶⁾ A = V_S connections reverse-polarity protected.

⁷⁾ B = output reverse-polarity protected.

⁸⁾ C = interference suppression.

⁹⁾ D = outputs overcurrent and short-circuit protected.

Mechanics

Dimensions (W x H x D)	23.5 mm x 76 mm x 55.8 mm
Housing material	Plastic, ABS
Optics material	Plastic, PMMA
Weight	120 g
Connection type	Cable, 5-wire, 2 m
Connection type Detail	
Cable diameter	Ø 3.8 mm
Conductor cross section	0.18 mm ²
Cable material	Plastic, PVC

Ambient data

Ambient operating temperature	-10 °C ... +50 °C
Ambient temperature, storage	-40 °C ... +70 °C
Electromagnetic compatibility (EMC)	EN 60947-5-2

Classifications

ECLASS 5.0	27270904
ECLASS 5.1.4	27270904
ECLASS 6.0	27270904
ECLASS 6.2	27270904
ECLASS 7.0	27270904
ECLASS 8.0	27270904
ECLASS 8.1	27270904
ECLASS 9.0	27270904
ECLASS 10.0	27270904
ECLASS 11.0	27270904
ECLASS 12.0	27270903
ETIM 5.0	EC002719
ETIM 6.0	EC002719
ETIM 7.0	EC002719
ETIM 8.0	EC002719
UNSPSC 16.0901	39121528

Dimensional drawing (Dimensions in mm (inch))

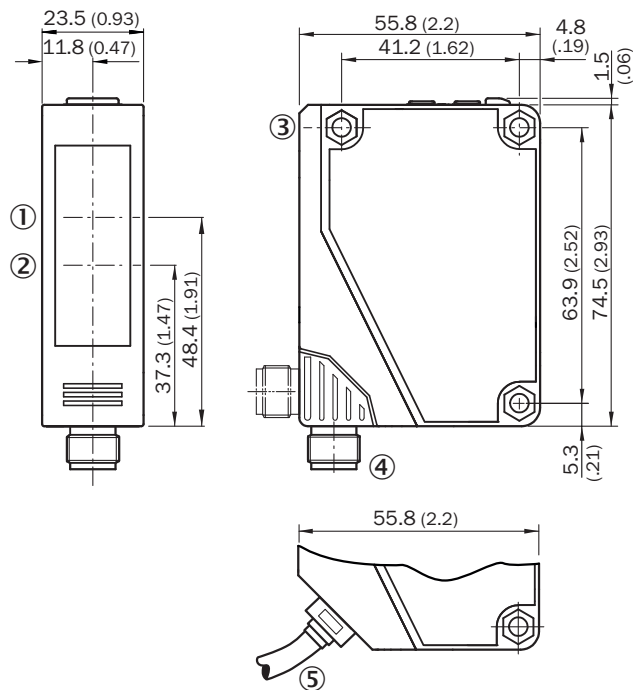

- ① Center of optical axis, receiver
- ② Center of optical axis, sender
- ③ Mounting hole, \varnothing 4.3 mm
- ④ M12 plug connector, 5-pin, can be rotated through 90°
- ⑤ Cable, 2 m, 5-wire, \varnothing 3.8 mm

Connection type

WTT280L-2x15xx WLT280L-2x15xx

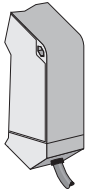

Connection diagram

Cd-208

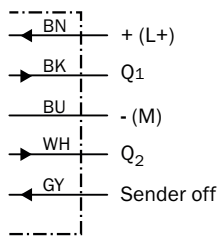

Adjustment possible

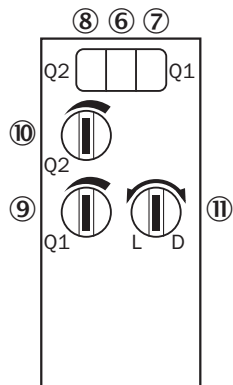

WxT280L-2xxxx6



- ⑥ LED indicator green: Stability indicator
- ⑦ Status indicator LED, yellow: Status of received light beam (switching output 1)
- ⑧ Status indicator LED, yellow: Status of received light beam (switching output 2)
- ⑨ Sensing range adjustment: potentiometer for switching output 1
- ⑩ Sensing range adjustment: potentiometer for switching output 2
- ⑪ Light/dark selector

Recommended accessories

Other models and accessories → www.sick.com/WTT280_PowerProx

	Brief description	Type	Part no.
Mounting brackets and plates			
	Mounting bracket, Stainless steel V2A (1.4301), 2 screws, 2 nuts, 2 circlips, 2 washers for mounting the sensor	BEF-W280	5313885
Reflectors			
	Rectangular, screw connection, 51 mm x 61 mm, PMMA/ABS, Screw-on, 2 hole mounting	P250	5304812
Others			
	<ul style="list-style-type: none"> • Connection type head A: Male connector, M12, 5-pin, straight, A-coded • Description: Unshielded, Head A: male connector, M12, 5-pin, straight, unshielded, for cable diameter 4 mm ... 6 mm Head B: - • Connection systems: Screw-type terminals • Permitted cross-section: ≤ 0.75 mm² • Note: For field bus technology 	STE-1205-G	6022083

SICK AT A GLANCE

SICK is one of the leading manufacturers of intelligent sensors and sensor solutions for industrial applications. A unique range of products and services creates the perfect basis for controlling processes securely and efficiently, protecting individuals from accidents and preventing damage to the environment.

We have extensive experience in a wide range of industries and understand their processes and requirements. With intelligent sensors, we can deliver exactly what our customers need. In application centers in Europe, Asia and North America, system solutions are tested and optimized in accordance with customer specifications. All this makes us a reliable supplier and development partner.

Comprehensive services complete our offering: SICK LifeTime Services provide support throughout the machine life cycle and ensure safety and productivity.

For us, that is “Sensor Intelligence.”

WORLDWIDE PRESENCE:

Contacts and other locations –www.sick.com