



WSE4FP-6G312100ZZZ

W4

MINIATURE PHOTOELECTRIC SENSORS

SICK
Sensor Intelligence.



Illustration may differ

Ordering information

| Type | Part no. |
|--------------------|----------|
| WSE4FP-6G312100ZZZ | 1123899 |

Other models and accessories → www.sick.com/W4



Detailed technical data

Features

| | |
|---|---|
| Functional principle | Through-beam photoelectric sensor |
| Sensing range | |
| Sensing range min. | 0 m |
| Sensing range max. | 10 m |
| Maximum distance range from receiver to sender (operating reserve 1) | 0 m ... 10 m |
| Recommended distance range from receiver to sender (operating reserve 2) | 0 m ... 7.5 m |
| Recommended sensing range for the best performance | 0 m ... 7.5 m |
| Emitted beam | |
| Light source | PinPoint LED |
| Type of light | Visible red light |
| Shape of light spot | Point-shaped |
| Light spot size (distance) | Ø 40 mm (1,000 mm) |
| Maximum dispersion of the emitted beam around the standardized transmission axis (squint angle) | < +/- 1.5° (at T _a = +23 °C) |
| Key LED figures | |
| Normative reference | EN 62471:2008-09 IEC 62471:2006, modified |
| LED risk group marking | Free group |
| Wave length | 635 nm |
| Average service life | 100,000 h at T _a = +25 °C |

| | | |
|---|------------|--|
| Adjustment | Wire/pin | For deactivation of the sender and execution of test logic |
| Indication | LED blue | BluePilot: Alignment aid |
| | LED green | Operating indicator Static on: power on |
| | LED yellow | Status of received light beam Static on: object not present Static off: object present |
| Part number of individual components | | WS04FP-6G3ZZ1A0ZZZ, 2126119 WE04FP-6G312100ZZZ, 2126124 |

Safety-related parameters

| | |
|-------------------------------------|-----------|
| MTTF_D | 574 years |
| DC_{avg} | 0 % |
| T_M (mission time) | 20 years |

Electrical data

| | | |
|--------------------------------------|--|--|
| Supply voltage U_B | 10 V DC ... 30 V DC ¹⁾ | |
| Ripple | ≤ 5 V _{pp} | |
| Usage category | DC-12 (According to EN 60947-5-2) DC-13 (According to EN 60947-5-2) | |
| Current consumption | ≤ 20 mA, without load. At U _B = 24 V | |
| Protection class | III | |
| Digital output | Number | 1 |
| | Type | Push-pull: PNP/NPN |
| | Switching mode | Light switching |
| | Signal voltage PNP HIGH/LOW | Approx. U _B -2.5 V / 0 V |
| | Signal voltage NPN HIGH/LOW | Approx. U _B / < 2.5 V |
| | Output current I _{max.} | ≤ 100 mA |
| | Circuit protection outputs | Reverse polarity protected Overcurrent protected Short-circuit protected |
| | Response time | ≤ 500 μs |
| | Switching frequency | 1,000 Hz ²⁾ |
| Pin/Wire assignment, sender | | |
| Function of pin 4/black (BK) | Input, sender off, LOW active | |
| Pin/Wire assignment, receiver | | |
| Function of pin 4/black (BK) | Digital output, light switching, object present → output Q LOW ³⁾ | |

¹⁾ Limit values.

²⁾ With light/dark ratio 1:1.

³⁾ This switching output must not be connected to another output.

Mechanical data

| | |
|----------------------|-------------|
| Housing | Rectangular |
| Design detail | Flat |

| | |
|---|---------------------------|
| Dimensions (W x H x D) | 16 mm x 40.1 mm x 12.1 mm |
| Connection | Cable, 3-wire, 5 m |
| Connection detail | |
| Deep-freeze property | Do not bend below 0 °C |
| Conductor size | 0.14 mm ² |
| Cable diameter | Ø 3.4 mm |
| Length of cable (L) | 5 m |
| Material | |
| Housing | Plastic, VISTAL® |
| Front screen | Plastic, PMMA |
| Cable | Plastic, PVC |
| Weight | Approx. 30 g |
| Maximum tightening torque of the fixing screws | 0.4 Nm |

Ambient data

| | |
|--|---|
| Enclosure rating | IP66 (EN 60529) IP67 (EN 60529) |
| Ambient operating temperature | -40 °C ... +60 °C |
| Ambient temperature, storage | -40 °C ... +75 °C |
| Typ. Ambient light immunity | Artificial light: ≤ 15,000 lx Sunlight: ≤ 50,000 lx |
| Shock resistance | 30 g, 11 ms (3 positive and 3 negative shocks along X, Y, Z axes, 18 total shocks (EN60068-2-27)) |
| Vibration resistance | 10 Hz ... 1,000 Hz (Amplitude 1 mm, 3 x 30 min (EN60068-2-6)) |
| Air humidity | 35 % ... 95 %, relative humidity (no condensation) |
| Electromagnetic compatibility (EMC) | EN 60947-5-2 |
| Resistance to cleaning agent | ECOLAB |
| UL File No. | NRKH.E181493 & NRKH7.E181493 |

Classifications

| | |
|---------------------|----------|
| ECLASS 5.0 | 27270901 |
| ECLASS 5.1.4 | 27270901 |
| ECLASS 6.0 | 27270901 |
| ECLASS 6.2 | 27270901 |
| ECLASS 7.0 | 27270901 |
| ECLASS 8.0 | 27270901 |
| ECLASS 8.1 | 27270901 |
| ECLASS 9.0 | 27270901 |
| ECLASS 10.0 | 27270901 |
| ECLASS 11.0 | 27270901 |
| ECLASS 12.0 | 27270901 |
| ETIM 5.0 | EC002716 |
| ETIM 6.0 | EC002716 |
| ETIM 7.0 | EC002716 |

| | |
|-----------------------|----------|
| ETIM 8.0 | EC002716 |
| UNSPSC 16.0901 | 39121528 |

Adjustments

Display and adjustment elements

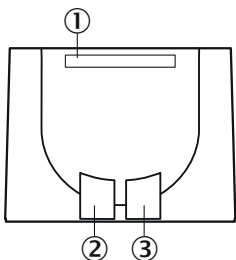

- ① LED blue
- ② LED green
- ③ LED yellow

Connection type

Cable, 3-wire

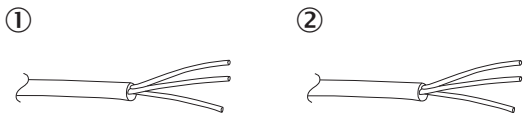

- ① Sender
- ② Receiver

Connection diagram

Cd-519

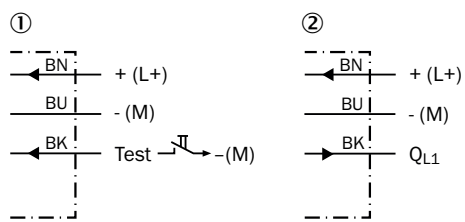

- ① Sender
- ② Receiver

Truth table

Push-pull: PNP/NPN – dark switching \bar{Q}

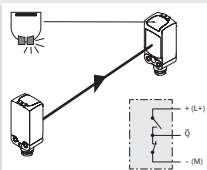
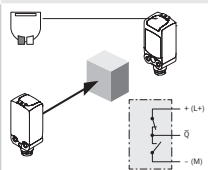
| | Dark switching \bar{Q} (normally open (upper switch), normally closed (lower switch)) | |
|-------------------------|---|---|
| | Object not present → Output LOW | Object present → Output HIGH |
| Light receive | ✓ | ✗ |
| Light receive indicator | ☉ | ✗ |
| Load resistance to L+ | ⚠ | ✗ |
| Load resistance to M | ✗ | ⚠ |
| |  |  |

Push-pull: PNP/NPN - light switching Q

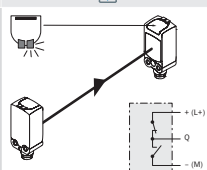
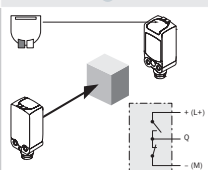
| | Light switching Q (normally closed (upper switch), normally open (lower switch)) | |
|-------------------------|--|--|
| | Object not present → Output HIGH | Object present → Output LOW |
| Light receive | ✓ | ✗ |
| Light receive indicator | ☉ | ✗ |
| Load resistance to L+ | ✗ | ⚠ |
| Load resistance to M | ⚠ | ✗ |
| |  |  |

Characteristic curve

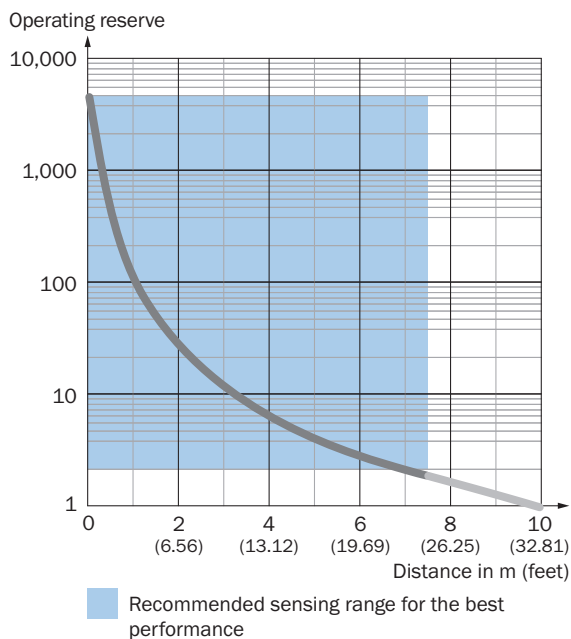

Light spot size

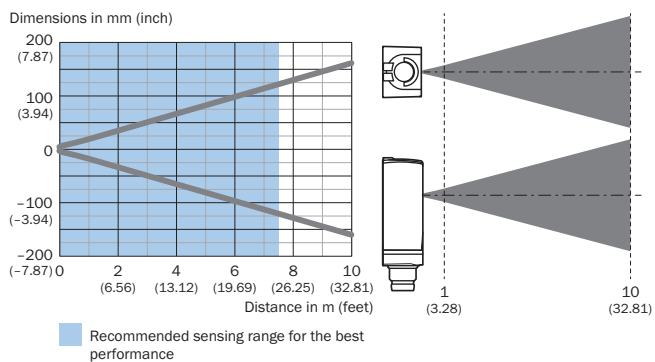

Sensing range diagram

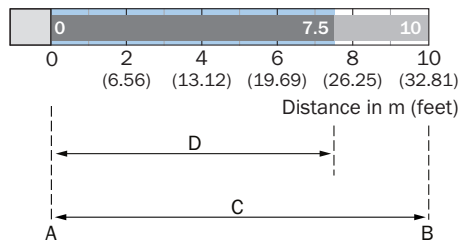

- A = Sensing range min. in m
- B = Sensing range max. in m
- C = Maximum distance range from receiver to sender
- D = Recommended distance range from receiver to sender

Recommended sensing range for the best performance

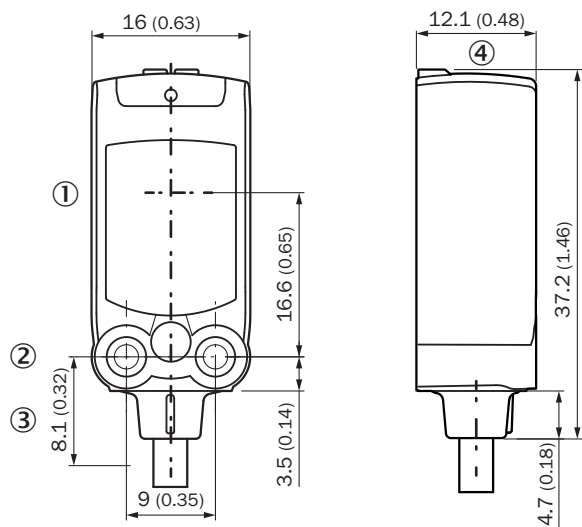

Dimensional drawing (Dimensions in mm (inch))



- ① Center of optical axis
- ② M3 mounting hole
- ③ Connection
- ④ Display and adjustment elements

Recommended accessories

Other models and accessories → www.sick.com/W4

| | Brief description | Type | Part no. |
|---|--|------------|----------|
| Mounting brackets and plates | | | |
|  | Mounting bracket for wall mounting, Stainless steel 1.4571, mounting hardware included | BEF-W4-A | 2051628 |
| Others | | | |
|  | <ul style="list-style-type: none"> • Connection type head A: Male connector, M8, 3-pin, straight, A-coded • Description: Unshielded • Connection systems: Screw-type terminals • Permitted cross-section: 0.14 mm² ... 0.5 mm² | STE-0803-G | 6037322 |

SICK AT A GLANCE

SICK is one of the leading manufacturers of intelligent sensors and sensor solutions for industrial applications. A unique range of products and services creates the perfect basis for controlling processes securely and efficiently, protecting individuals from accidents and preventing damage to the environment.

We have extensive experience in a wide range of industries and understand their processes and requirements. With intelligent sensors, we can deliver exactly what our customers need. In application centers in Europe, Asia and North America, system solutions are tested and optimized in accordance with customer specifications. All this makes us a reliable supplier and development partner.

Comprehensive services complete our offering: SICK LifeTime Services provide support throughout the machine life cycle and ensure safety and productivity.

For us, that is “Sensor Intelligence.”

WORLDWIDE PRESENCE:

Contacts and other locations –www.sick.com