



WS/WE100-2P3439

W100-2

MINIATURE PHOTOELECTRIC SENSORS

SICK
Sensor Intelligence.



Illustration may differ



Ordering information

Type	Part no.
WS/WE100-2P3439	6052367

Included in delivery: BEF-W100-A (2)

Other models and accessories → www.sick.com/W100-2

Detailed technical data

Features

Functional principle	Through-beam photoelectric sensor
Dimensions (W x H x D)	11 mm x 31 mm x 20 mm
Housing design (light emission)	Rectangular
Sensing range max.	0 m ... 33 m
Sensing range	0 m ... 20 m
Type of light	Visible red light
Light source	LED ¹⁾
Light spot size (distance)	Ø 850 mm (12 m)
Wave length	632 nm
Adjustment	Potentiometer, 270° (Sensitivity)

¹⁾ Average service life: 100,000 h at T_U = +25 °C.

Mechanics/electronics

Supply voltage U_B	10 V DC ... 30 V DC ¹⁾
Ripple	± 10 % ²⁾
Power consumption, sender	≤ 15 mA ³⁾
Power consumption, receiver	≤ 20 mA ³⁾

¹⁾ Limit values.

²⁾ May not fall below or exceed U_y tolerances.

³⁾ Without load.

⁴⁾ Signal transit time with resistive load.

⁵⁾ With light/dark ratio 1:1.

⁶⁾ A = V_S connections reverse-polarity protected.

⁷⁾ B = output reverse-polarity protected.

⁸⁾ D = outputs overcurrent and short-circuit protected.

Switching output	PNP
Switching mode	Light/dark switching
Switching mode selector	Selectable via light/dark rotary switch
Signal voltage PNP HIGH/LOW	$U_V - 1,8 \text{ V} / \text{ca. } 0 \text{ V}$
Output current I_{max}	$\leq 100 \text{ mA}$
Response time	$\leq 0,5 \text{ ms}^{4)}$
Switching frequency	$1,000 \text{ Hz}^{5)}$
Connection type	Connector M8, 3-pin
Circuit protection	A ⁶⁾ B ⁷⁾ D ⁸⁾
Protection class	III
Housing material	Plastic, ABS/PC/POM
Optics material	Plastic, PMMA
Enclosure rating	IP67
Items supplied	2 Stainless steel mounting brackets (1.4301/304) BEF-W100-A
Ambient operating temperature	$-25 \text{ }^\circ\text{C} \dots +55 \text{ }^\circ\text{C}$
Ambient temperature, storage	$-40 \text{ }^\circ\text{C} \dots +70 \text{ }^\circ\text{C}$

1) Limit values.

2) May not fall below or exceed U_V tolerances.

3) Without load.

4) Signal transit time with resistive load.

5) With light/dark ratio 1:1.

6) A = V_S connections reverse-polarity protected.

7) B = output reverse-polarity protected.

8) D = outputs overcurrent and short-circuit protected.

Classifications

ECLASS 5.0	27270901
ECLASS 5.1.4	27270901
ECLASS 6.0	27270901
ECLASS 6.2	27270901
ECLASS 7.0	27270901
ECLASS 8.0	27270901
ECLASS 8.1	27270901
ECLASS 9.0	27270901
ECLASS 10.0	27270901
ECLASS 11.0	27270901
ECLASS 12.0	27270901
ETIM 5.0	EC002716
ETIM 6.0	EC002716
ETIM 7.0	EC002716
ETIM 8.0	EC002716
UNSPSC 16.0901	39121528

Dimensional drawing (Dimensions in mm (inch))

WS/WE100

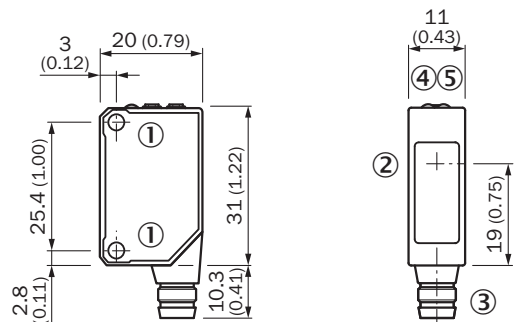

- ① Threaded mounting hole M3
- ② Center of optical axis
- ③ Connection
- ④ LED indicator orange: switching output active
- ⑤ LED indicator green: power on

Adjustments

W100-2

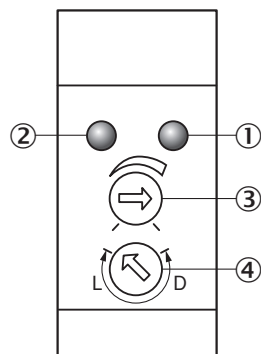

- ① LED indicator orange: switching output active
- ② LED indicator green: power on
- ③ Sensing range adjustment: potentiometer
- ④ Light/ dark rotary switch: L = light switching, D = dark switching

Connection diagram

Cd-051

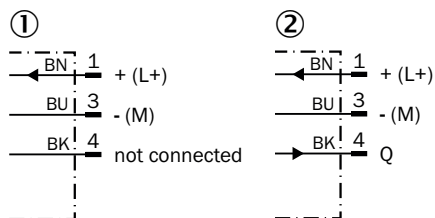

- ① Sender
- ② Receiver

Characteristic curve

WS/WE100-2

Function reserve

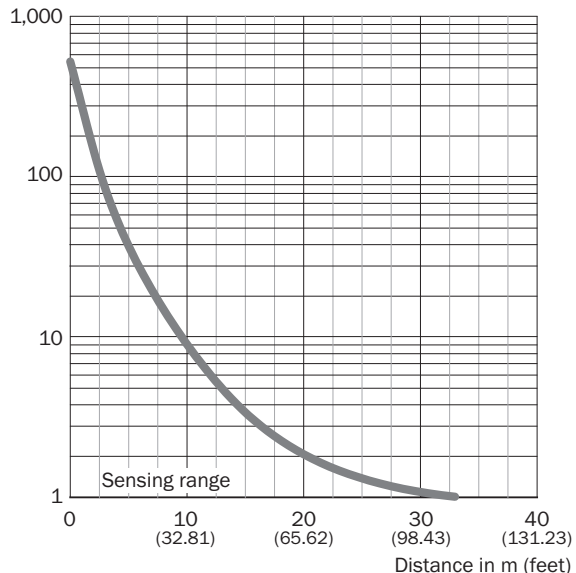

Light spot size

Light spot size

Diameter in mm (inch)

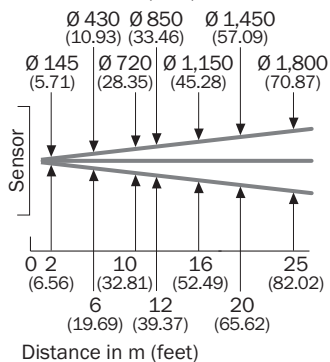



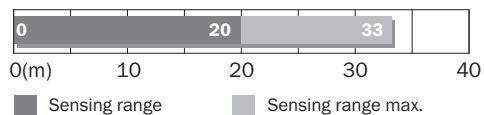

Sensing range diagram

WS/WE100-2



Recommended accessories

Other models and accessories → www.sick.com/W100-2

	Brief description	Type	Part no.
Mounting brackets and plates			
	Mounting bracket for wall mounting, stainless steel, mounting hardware included	BEF-W100-A	5311520
	Mounting bracket for floor mounting, steel, zinc coated, mounting hardware included	BEF-W100-B	5311521
Others			
	<ul style="list-style-type: none"> • Connection type head A: Female connector, M8, 3-pin, straight, A-coded • Connection type head B: Flying leads • Signal type: Sensor/actuator cable • Cable: 5 m, 3-wire, PVC • Description: Sensor/actuator cable, unshielded • Application: Zones with chemicals 	YF8U13-050VA1XLEAX	2095884
	<ul style="list-style-type: none"> • Connection type head A: Male connector, M8, 3-pin, straight, A-coded • Description: Unshielded • Connection systems: Screw-type terminals • Permitted cross-section: 0.14 mm² ... 0.5 mm² 	STE-0803-G	6037322

SICK AT A GLANCE

SICK is one of the leading manufacturers of intelligent sensors and sensor solutions for industrial applications. A unique range of products and services creates the perfect basis for controlling processes securely and efficiently, protecting individuals from accidents and preventing damage to the environment.

We have extensive experience in a wide range of industries and understand their processes and requirements. With intelligent sensors, we can deliver exactly what our customers need. In application centers in Europe, Asia and North America, system solutions are tested and optimized in accordance with customer specifications. All this makes us a reliable supplier and development partner.

Comprehensive services complete our offering: SICK LifeTime Services provide support throughout the machine life cycle and ensure safety and productivity.

For us, that is “Sensor Intelligence.”

WORLDWIDE PRESENCE:

Contacts and other locations –www.sick.com