



WT12L-2B510

W12-2 Laser

SMALL PHOTOELECTRIC SENSORS

SICK
Sensor Intelligence.



Ordering information

Type	Part no.
WT12L-2B510	1017959

Included in delivery: BEF-KH-W12 (2)

Other models and accessories → www.sick.com/W12-2_Laser

Illustration may differ



Detailed technical data

Features

Functional principle	Photoelectric proximity sensor
Functional principle detail	Background suppression
Sensing range max.	20 mm ... 50 mm ¹⁾
Emitted beam	
Light source	Laser ²⁾
Type of light	Visible red light
Light spot size (distance)	Ø 0.1 mm (45 mm)
Focus position	45 mm
Key laser figures	
Normative reference	EN 60825-1:2014, IEC 60825-1:2007
Laser class	2 ³⁾
Key LED figures	
Wave length	650 nm
Adjustment	None
Special applications	Detecting small objects, Detection of objects moving at high speeds
Items supplied	2 x clamps BEF-KH-W12, incl. screws

¹⁾ Object with 6% remission (based on standard white, DIN 5033).

²⁾ Average service life: 50,000 h at T_U = +25 °C.

³⁾ Pulse length 4 µs, max. pulse power < 5,0 mW.

Safety-related parameters

MTTF_D	293 years
DC_{avg}	0 %

Electrical data

Supply voltage U_B	10 V DC ... 30 V DC ¹⁾
Ripple	< 5 V _{pp} ²⁾
Current consumption	55 mA ³⁾
Protection class	III
Digital output	
Type	PNP, NPN ^{4) 5)}
Switching mode	Light switching, Dark switching ^{4) 5)}
Switching mode selector	Selectable via L/D control cable
Signal voltage PNP HIGH/LOW	U _v - < 2 V, U _v / 0 V, <= 1.5 V
Signal voltage NPN HIGH/LOW	U _v - < 2 V, U _v / 0 V, <= 1.5 V
Output current I _{max.}	≤ 100 mA
Response time	≤ 200 μs ⁶⁾
Switching frequency	2,500 Hz ⁷⁾
Circuit protection	A ⁸⁾ C ⁹⁾ D ¹⁰⁾

¹⁾ Limit values when operated in short-circuit protected network: max. 8 A.

²⁾ May not fall below or exceed U_y tolerances.

³⁾ Without load.

⁴⁾ 0 V or not connected, light switching.

⁵⁾ U_v, dark switching.

⁶⁾ Signal transit time with resistive load.

⁷⁾ With light/dark ratio 1:1.

⁸⁾ A = V_S connections reverse-polarity protected.

⁹⁾ C = interference suppression.

¹⁰⁾ D = outputs overcurrent and short-circuit protected.

Mechanical data

Housing	Rectangular
Dimensions (W x H x D)	15 mm x 49 mm x 41.5 mm
Connection	Male connector M12, 5-pin
Material	
Housing	Metal
Front screen	Plastic, PMMA
Weight	130 g

Ambient data

Enclosure rating	IP67 IP69K
Ambient operating temperature	-10 °C ... +50 °C
Ambient temperature, storage	-25 °C ... +75 °C
UL File No.	NRKH.E181493 & NRKH7.E181493

Classifications

ECLASS 5.0	27270904
-------------------	----------

ECLASS 5.1.4	27270904
ECLASS 6.0	27270904
ECLASS 6.2	27270904
ECLASS 7.0	27270904
ECLASS 8.0	27270904
ECLASS 8.1	27270904
ECLASS 9.0	27270904
ECLASS 10.0	27270904
ECLASS 11.0	27270904
ECLASS 12.0	27270903
ETIM 5.0	EC002719
ETIM 6.0	EC002719
ETIM 7.0	EC002719
ETIM 8.0	EC002719
UNSPSC 16.0901	39121528

Adjustments

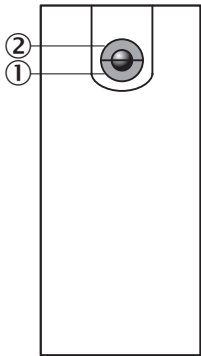

- ① Operating indicator, green
- ② LED reception indicator, yellow

WT12L-2

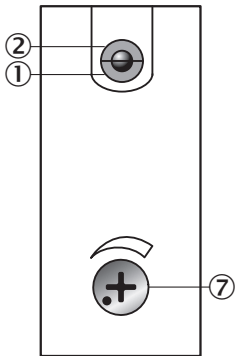

- ① Operating indicator, green
- ② LED reception indicator, yellow
- ⑦ Adjustment of sensing range

Connection type

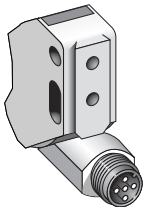

Connection diagram

Cd-145

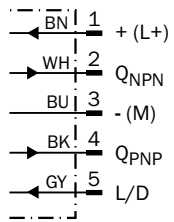

Characteristic curve

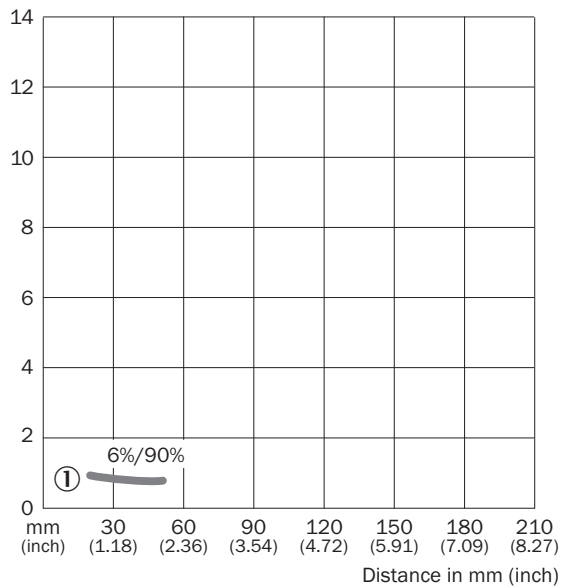

Sensing range diagram

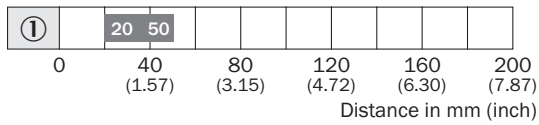

■ Sensing range

① Sensing range on black, 6 % remission, fix

Dimensional drawing (Dimensions in mm (inch))

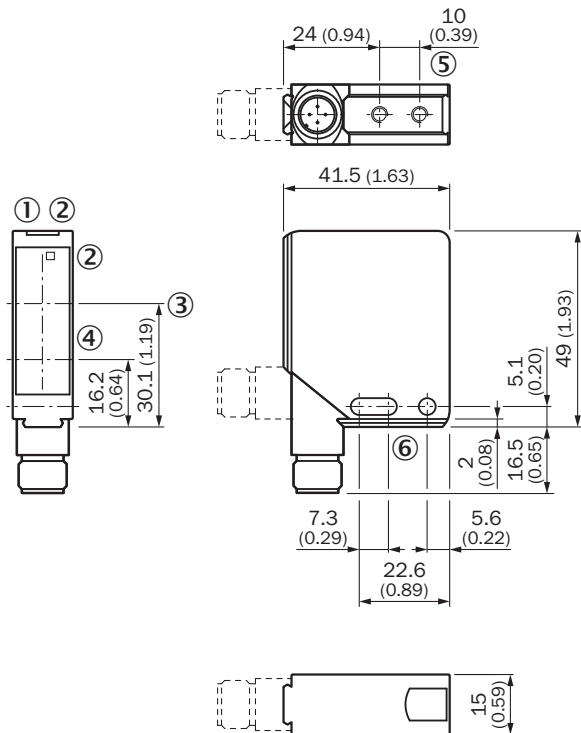

- ① Operating indicator, green
- ② LED reception indicator, yellow
- ③ Optical axis, receiver
- ④ Optical axis, sender
- ⑤ M4 threaded mounting hole – 4 mm depth
- ⑥ Mounting hole, Ø 4.2 mm

SICK AT A GLANCE

SICK is one of the leading manufacturers of intelligent sensors and sensor solutions for industrial applications. A unique range of products and services creates the perfect basis for controlling processes securely and efficiently, protecting individuals from accidents and preventing damage to the environment.

We have extensive experience in a wide range of industries and understand their processes and requirements. With intelligent sensors, we can deliver exactly what our customers need. In application centers in Europe, Asia and North America, system solutions are tested and optimized in accordance with customer specifications. All this makes us a reliable supplier and development partner.

Comprehensive services complete our offering: SICK LifeTime Services provide support throughout the machine life cycle and ensure safety and productivity.

For us, that is “Sensor Intelligence.”

WORLDWIDE PRESENCE:

Contacts and other locations –www.sick.com