



WT150-P430

W150

MINIATURE PHOTOELECTRIC SENSORS

SICK
Sensor Intelligence.



Illustration may differ



Ordering information

Type	Part no.
WT150-P430	6011044

Included in delivery: BEF-W150-A (1)

Other models and accessories → www.sick.com/W150

Detailed technical data

Features

Functional principle	Photoelectric proximity sensor
Functional principle detail	Energetic
Dimensions (W x H x D)	10 mm x 28 mm x 17.5 mm
Housing design (light emission)	Rectangular
Sensing range max.	10 mm ... 250 mm ¹⁾
Sensing range	10 mm ... 200 mm
Focus	Approx. 6°
Type of light	Visible red light
Light source	LED ²⁾
Angle of dispersion	Approx. 6°
Adjustment	Potentiometer, 270°

¹⁾ Object with 90% remission (based on standard white, DIN 5033).

²⁾ Average service life: 100,000 h at T_J = +25 °C.

Mechanics/electronics

Supply voltage U_B	10 V DC ... 30 V DC ¹⁾
Ripple	± 10 % ²⁾
Current consumption	20 mA ³⁾
Switching output	PNP

¹⁾ Limit values.

²⁾ May not fall below or exceed U_V tolerances.

³⁾ Without load.

⁴⁾ Signal transit time with resistive load.

⁵⁾ With light/dark ratio 1:1.

⁶⁾ A = V_S connections reverse-polarity protected.

⁷⁾ B = inputs and output reverse-polarity protected.

⁸⁾ C = interference suppression.

⁹⁾ D = outputs overcurrent and short-circuit protected.

Switching mode	Light/dark switching
Switching mode selector	Selectable via L/D control cable
Output current I_{\max}	≤ 100 mA
Response time	≤ 0.5 ms ⁴⁾
Switching frequency	1,000 Hz ⁵⁾
Connection type	Male connector M8, 4-pin
Circuit protection	A ⁶⁾ B ⁷⁾ C ⁸⁾ D ⁹⁾
Protection class	II
Weight	7 g
Housing material	Plastic, ABS
Optics material	Plastic, PC
Enclosure rating	IP67
Items supplied	BEF-W150-A mounting bracket
Ambient operating temperature	-25 °C ... +55 °C
Ambient temperature, storage	-40 °C ... +75 °C
UL File No.	NRNT2.E128350 & NRNT8.E128350

1) Limit values.

2) May not fall below or exceed U_V tolerances.

3) Without load.

4) Signal transit time with resistive load.

5) With light/dark ratio 1:1.

6) A = V_S connections reverse-polarity protected.

7) B = inputs and output reverse-polarity protected.

8) C = interference suppression.

9) D = outputs overcurrent and short-circuit protected.

Safety-related parameters

MTTF_D	1,686 years
DC_{avg}	0 %

Classifications

ECLASS 5.0	27270903
ECLASS 5.1.4	27270903
ECLASS 6.0	27270903
ECLASS 6.2	27270903
ECLASS 7.0	27270903
ECLASS 8.0	27270903
ECLASS 8.1	27270903
ECLASS 9.0	27270903
ECLASS 10.0	27270904
ECLASS 11.0	27270904
ECLASS 12.0	27270903

ETIM 5.0	EC001821
ETIM 6.0	EC001821
ETIM 7.0	EC002719
ETIM 8.0	EC002719
UNSPSC 16.0901	39121528

Adjustments

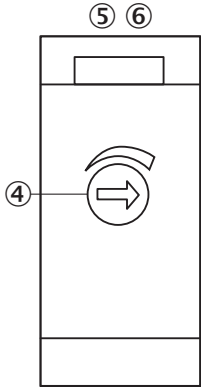

- ⑤ Sensing range adjustment: potentiometer, 5 turns
- ⑥ LED indicator green: stability indicator
- ⑦ LED indicator orange: output active

Connection type

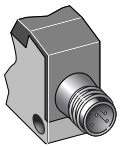

Connection diagram

Cd-087

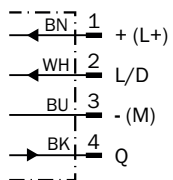

Characteristic curve

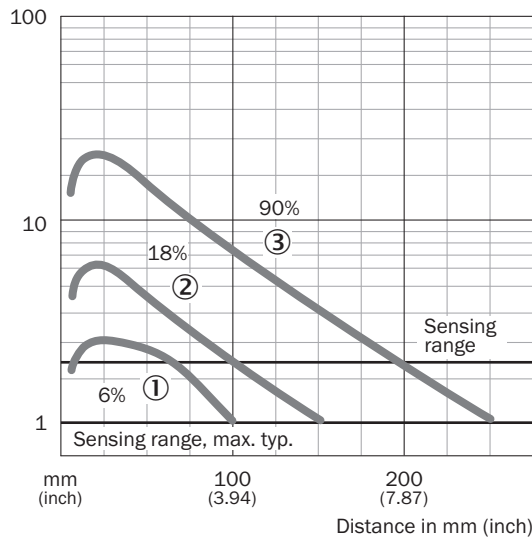

Sensing range diagram

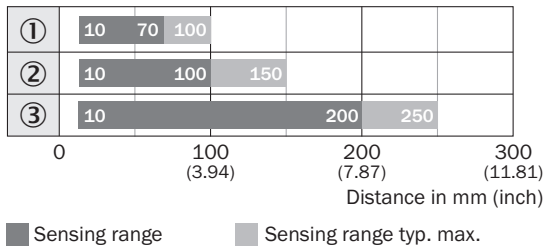

- ① Sensing range on black, 6 % remission
- ② Sensing range on gray, 18 % remission
- ③ Sensing range on white, 90 % remission

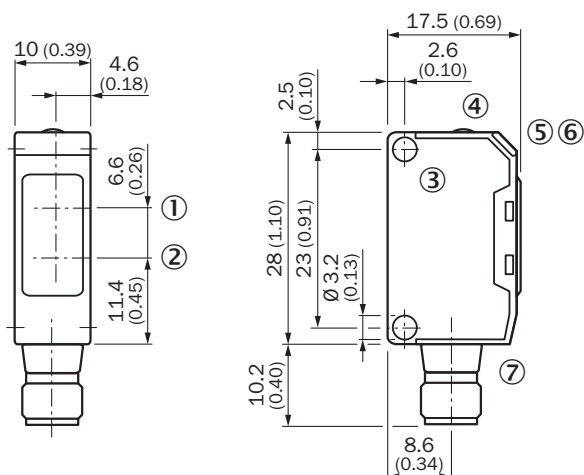

Dimensional drawing (Dimensions in mm (inch))



- ① Standard direction of the material being detected
- ② Center of optical axis, receiver
- ③ Center of optical axis, sender
- ④ Mounting hole, \varnothing 3.2 mm
- ⑤ Sensing range adjustment: potentiometer, 5 turns
- ⑥ LED indicator green: stability indicator
- ⑦ LED indicator orange: output active
- ⑧ Connection

Recommended accessories

Other models and accessories → www.sick.com/W150

	Brief description	Type	Part no.
Others			
	<ul style="list-style-type: none"> • Connection type head A: Male connector, M8, 4-pin, straight, A-coded • Description: Unshielded • Connection systems: Screw-type terminals • Permitted cross-section: 0.14 mm² ... 0.5 mm² 	STE-0804-G	6037323
	<ul style="list-style-type: none"> • Connection type head A: Female connector, M8, 4-pin, straight, A-coded • Connection type head B: Flying leads • Signal type: Sensor/actuator cable • Cable: 5 m, 4-wire, PVC • Description: Sensor/actuator cable, unshielded • Application: Zones with chemicals 	YF8U14-050VA3XLEAX	2095889

SICK AT A GLANCE

SICK is one of the leading manufacturers of intelligent sensors and sensor solutions for industrial applications. A unique range of products and services creates the perfect basis for controlling processes securely and efficiently, protecting individuals from accidents and preventing damage to the environment.

We have extensive experience in a wide range of industries and understand their processes and requirements. With intelligent sensors, we can deliver exactly what our customers need. In application centers in Europe, Asia and North America, system solutions are tested and optimized in accordance with customer specifications. All this makes us a reliable supplier and development partner.

Comprehensive services complete our offering: SICK LifeTime Services provide support throughout the machine life cycle and ensure safety and productivity.

For us, that is “Sensor Intelligence.”

WORLDWIDE PRESENCE:

Contacts and other locations –www.sick.com