



# WT24-2X200

## W24

COMPACT PHOTOELECTRIC SENSORS

**SICK**  
Sensor Intelligence.



Illustration may differ



## Ordering information

| Type       | Part no. |
|------------|----------|
| WT24-2X200 | 1041910  |

Other models and accessories → [www.sick.com/W24](http://www.sick.com/W24)

## Detailed technical data

### Features

|  |                                   |
|--|-----------------------------------|
| <b>Functional principle</b>            | Photoelectric proximity sensor    |
| <b>Functional principle detail</b>     | Background suppression            |
| <b>Dimensions (W x H x D)</b>          | 27 mm x 87.5 mm x 65 mm           |
| <b>Housing design (light emission)</b> | Rectangular                       |
| <b>Sensing range max.</b>              | 40 mm ... 2,000 mm <sup>1)</sup>  |
| <b>Sensing range</b>                   | 100 mm ... 2,000 mm <sup>1)</sup> |
| <b>Type of light</b>                   | Infrared light                    |
| <b>Light source</b>                    | LED <sup>2)</sup>                 |
| <b>Light spot size (distance)</b>      | Ø 50 mm (2,000 mm)                |
| <b>Adjustment</b>                      | Potentiometer                     |
| <b>Special applications</b>            | Explosive areas                   |

<sup>1)</sup> Object with 90% remission (based on standard white, DIN 5033).

<sup>2)</sup> Average service life: 100,000 h at T<sub>J</sub> = +25 °C.

### Mechanics/electronics

|                                     |                                     |
|-------------------------------------|-------------------------------------|
| <b>Supply voltage U<sub>B</sub></b> | 5 V DC ... 15.5 V DC                |
| <b>Ripple</b>                       | < 0.4 V <sub>pp</sub> <sup>1)</sup> |
| <b>Switching output</b>             | NAMUR                               |

<sup>1)</sup> May not fall below or exceed U<sub>y</sub> tolerances.

<sup>2)</sup> Signal transit time with resistive load.

<sup>3)</sup> With light/dark ratio 1:1.

<sup>4)</sup> A = V<sub>S</sub> connections reverse-polarity protected.

<sup>5)</sup> C = interference suppression.

<sup>6)</sup> Reference voltage: 50 V DC.

<sup>7)</sup> For connection to a separately certified intrinsically safe circuit only.

|   |  |
|---|--|
| <b>Switching mode</b>                             | Light switching  |
| <b>Response time</b>                              | $\leq 10 \text{ ms}^{2)}$  |
| <b>Switching frequency</b>                        | 50 Hz <sup>3)</sup>  |
| <b>Connection type</b>                            | Terminal connection with M16 gland                                 |
| <b>Circuit protection</b>                         | A <sup>4)</sup><br>C <sup>5)</sup>                                 |
| <b>Protection class</b>                           | II <sup>6)</sup>   |
| <b>Weight</b>                                     | 330 g  |
| <b>Housing material</b>                           | Metal, zinc diecast  |
| <b>Optics material</b>                            | Glass, glass   |
| <b>Enclosure rating</b>                           | IP67   |
| <b>Type approval certificate</b>                  | PTB 03 ATEX 2105   |
| <b>Certificate (IECEX)</b>                        | IECEX PTB 14.0030  |
| <b>ATEX marking</b>                               | ATEX II 2G Ex ia op is IIC T4 Gb according to directive 2014/34/EU |
| <b>Ex area category</b>                           | 2G   |
| <b>Input voltage <math>U_i</math> max.</b>        | 15.5 V <sup>7)</sup>   |
| <b>Input power <math>P_i</math> max.</b>          | 100 mW <sup>7)</sup>   |
| <b>Input current <math>I_i</math> max.</b>        | 53 mA <sup>7)</sup>  |
| <b>Internal capacitance <math>C_i</math> max.</b> | 80 nF <sup>7)</sup>  |
| <b>Internal inductance <math>L_i</math> max.</b>  | 0 $\mu\text{H}$ <sup>7)</sup>                                      |
| <b>Ambient operating temperature</b>              | -20 °C ... +60 °C  |
| <b>Ambient temperature, storage</b>               | -25 °C ... +70 °C  |

1) May not fall below or exceed  $U_y$  tolerances.

2) Signal transit time with resistive load.

3) With light/dark ratio 1:1.

4) A =  $V_S$  connections reverse-polarity protected.

5) C = interference suppression.

6) Reference voltage: 50 V DC.

7) For connection to a separately certified intrinsically safe circuit only.

## Safety-related parameters

|                                     |           |
|-------------------------------------|-----------|
| <b>MTTF<sub>D</sub></b>             | 227 years |
| <b>DC<sub>avg</sub></b>             | 0 %       |
| <b>T<sub>M</sub> (mission time)</b> | 20 years  |

## Classifications

|                     |          |
|---------------------|----------|
| <b>ECLASS 5.0</b>   | 27270904 |
| <b>ECLASS 5.1.4</b> | 27270904 |
| <b>ECLASS 6.0</b>   | 27270904 |
| <b>ECLASS 6.2</b>   | 27270904 |
| <b>ECLASS 7.0</b>   | 27270904 |
| <b>ECLASS 8.0</b>   | 27270904 |
| <b>ECLASS 8.1</b>   | 27270904 |

|                       |          |
|-----------------------|----------|
| <b>ECLASS 9.0</b>     | 27270904 |
| <b>ECLASS 10.0</b>    | 27270904 |
| <b>ECLASS 11.0</b>    | 27270904 |
| <b>ECLASS 12.0</b>    | 27270903 |
| <b>ETIM 5.0</b>       | EC002719 |
| <b>ETIM 6.0</b>       | EC002719 |
| <b>ETIM 7.0</b>       | EC002719 |
| <b>ETIM 8.0</b>       | EC002719 |
| <b>UNSPSC 16.0901</b> | 39121528 |

### Adjustments

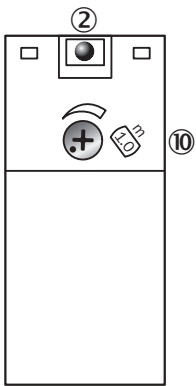

- ② LED signal strength indicator
- ⑩ Adjustment of sensing range

### Connection type

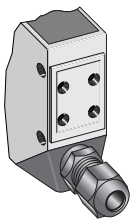

### Connection diagram

Cd-050

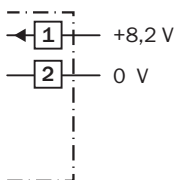

Characteristic curve

WT24-2 EX

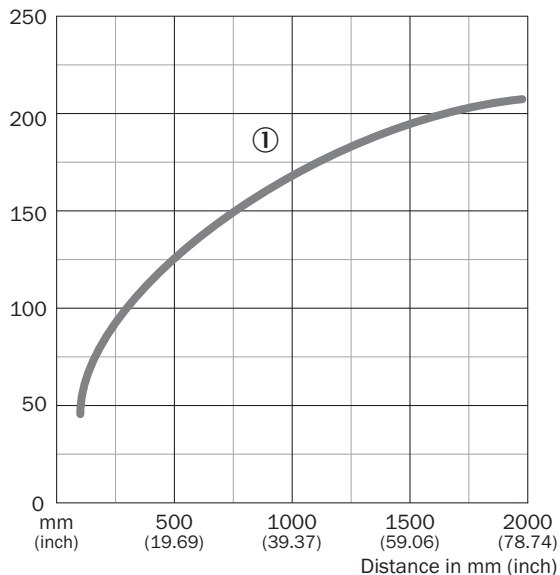

Field of view

① Sensing range on black, 6% remission factor

WT24-2 EX

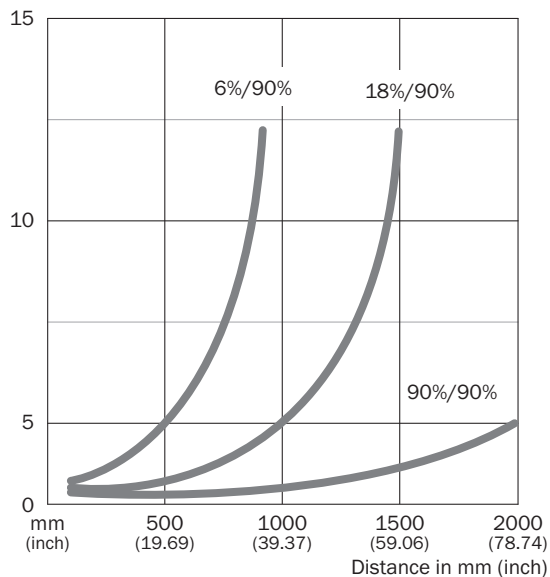

### Sensing range diagram

WT24-2

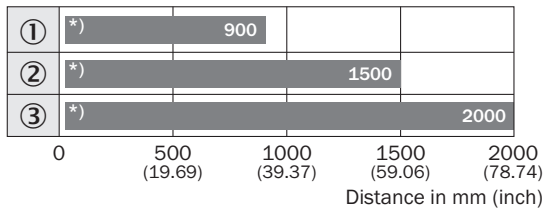

■ Sensing range

\*) Lower bound of detection area depending on the adjusted sensing distance (see blind zone curve)

- ① Sensing range on black, 6% remission factor
- ② Sensing range on gray, 18% remission factor
- ③ Sensing range on white, 90% remission factor

### Dimensional drawing (Dimensions in mm (inch))

WT24-2 EX

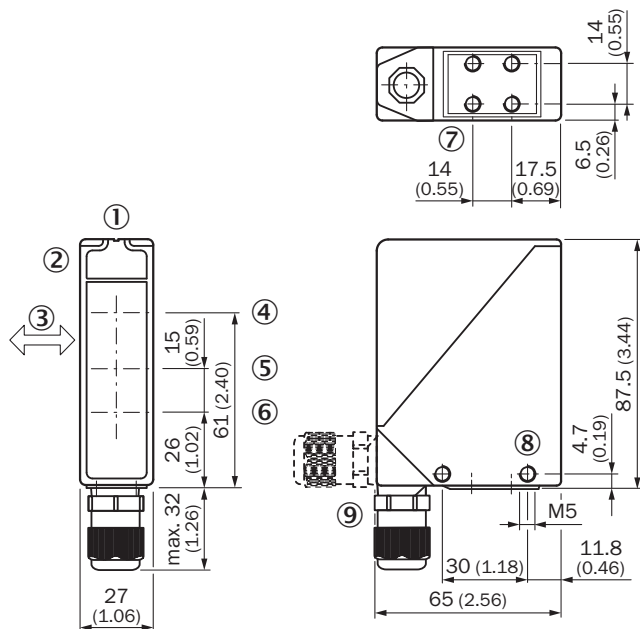

- ① Alignment sight
- ② LED signal strength indicator
- ③ Standard direction of the material being detected
- ④ Center of optical axis, sender
- ⑤ Center of optical axis, receiver (close range)
- ⑥ Center of optical axis, receiver (far range)
- ⑦ M5 threaded mounting hole, 6 mm deep
- ⑧ M5 threaded mounting hole, through-hole
- ⑨ M16 screw fixing and plug rotatable by 90°

## Recommended accessories

Other models and accessories → [www.sick.com/W24](http://www.sick.com/W24)

|   | Brief description  | Type       | Part no. |
|---|--|------------|----------|
| Mounting brackets and plates  |  |            |          |
|  | Mounting bracket, large, stainless steel, without mounting hardware for the sensor | BEF-WG-W24 | 4026324  |

## SICK AT A GLANCE

SICK is one of the leading manufacturers of intelligent sensors and sensor solutions for industrial applications. A unique range of products and services creates the perfect basis for controlling processes securely and efficiently, protecting individuals from accidents and preventing damage to the environment.

We have extensive experience in a wide range of industries and understand their processes and requirements. With intelligent sensors, we can deliver exactly what our customers need. In application centers in Europe, Asia and North America, system solutions are tested and optimized in accordance with customer specifications. All this makes us a reliable supplier and development partner.

Comprehensive services complete our offering: SICK LifeTime Services provide support throughout the machine life cycle and ensure safety and productivity.

For us, that is “Sensor Intelligence.”

## WORLDWIDE PRESENCE:

Contacts and other locations –[www.sick.com](http://www.sick.com)