



WT34-R240

W34

COMPACT PHOTOELECTRIC SENSORS

SICK
Sensor Intelligence.



Ordering information

Type	Part no.
WT34-R240	1019239

Other models and accessories → www.sick.com/W34

Illustration may differ



Detailed technical data

Features

Functional principle	Photoelectric proximity sensor
Functional principle detail	Background suppression
Dimensions (W x H x D)	27 mm x 92 mm x 70 mm
Housing design (light emission)	Rectangular
Sensing range max.	100 mm ... 1,200 mm ¹⁾
Sensing range	100 mm ... 1,200 mm
Type of light	Visible red light
Light source	LED ²⁾
Light spot size (distance)	Ø 40 mm (1,200 mm)
Wave length	660 nm
Adjustment	Potentiometer

¹⁾ Object with 90% remission (based on standard white, DIN 5033).

²⁾ Average service life: 100,000 h at T_J = +25 °C.

Mechanics/electronics

Supply voltage U_B	20 V AC/DC ... 250 V AC/DC
Power consumption	< 2 VA
Switching output	Relay, electrically isolated ¹⁾
Output function	Change-over contacts
Switching mode	Light switching, Dark switching ¹⁾
Switching mode selector	Selectable via light/dark selector
Switching current (switching voltage)	4 A @ 250 V AC, 4 A @ 24 V DC, 0.125 A @ 250 V DC

¹⁾ Provide suitable spark suppression for inductive or capacitive loads.

²⁾ With light/dark ratio 1:1.

³⁾ A = V_S connections reverse-polarity protected.

⁴⁾ C = interference suppression.

⁵⁾ Rated voltage: 250 V AC/DC.

	UL: 4 A @ 250 V AC, general use / 4 A @ 250 V AC, resistive (NO) / 3 A @ 250 V AC, resistive (NC) / 4 A @ 24 V DC, NO, general use / 3 A @ 24 V DC, NC, general use / R300 / B300 (NO contacts only)
Response time	≤ 10 ms
Switching frequency	10 Hz ²⁾
Connection type	Terminal connection with M16 gland
Circuit protection	A ³⁾ C ⁴⁾
Protection class	II ⁵⁾
Weight	140 g
Housing material	Plastic, ABS
Enclosure rating	IP67
Ambient operating temperature	-40 °C ... +60 °C
Ambient temperature, storage	-40 °C ... +75 °C
UL File No.	NRKH.E181493 & NRKH7.E181493

¹⁾ Provide suitable spark suppression for inductive or capacitive loads.

²⁾ With light/dark ratio 1:1.

³⁾ A = V_S connections reverse-polarity protected.

⁴⁾ C = interference suppression.

⁵⁾ Rated voltage: 250 V AC/DC.

Safety-related parameters

MTTF_D	509 years
DC_{avg}	0 %
T_M (mission time)	20 years

Classifications

ECLASS 5.0	27270904
ECLASS 5.1.4	27270904
ECLASS 6.0	27270904
ECLASS 6.2	27270904
ECLASS 7.0	27270904
ECLASS 8.0	27270904
ECLASS 8.1	27270904
ECLASS 9.0	27270904
ECLASS 10.0	27270904
ECLASS 11.0	27270904
ECLASS 12.0	27270903
ETIM 5.0	EC002719
ETIM 6.0	EC002719
ETIM 7.0	EC002719
ETIM 8.0	EC002719
UNSPSC 16.0901	39121528

Dimensional drawing (Dimensions in mm (inch))

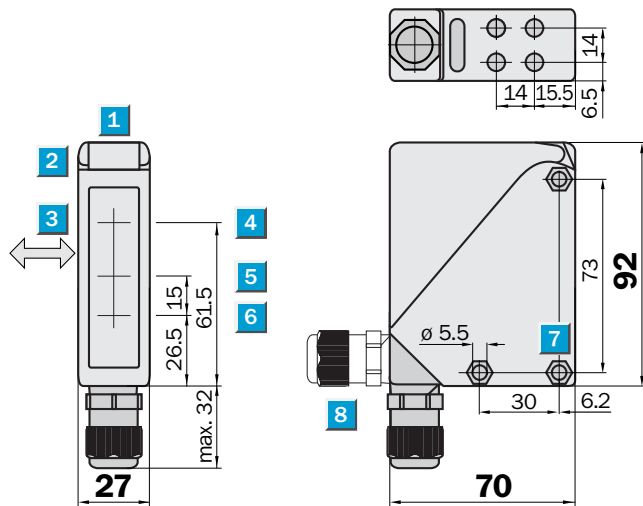

- ① Alignment sight
- ② LED signal strength indicator
- ③ Standard direction of the material being detected
- ④ Center of optical axis, sender
- ⑤ Center of optical axis, receiver (close range)
- ⑥ Center of optical axis, receiver (far range)
- ⑦ Mounting hole \varnothing 5.5 mm, for M5 hexagon nuts on both sides

Adjustments

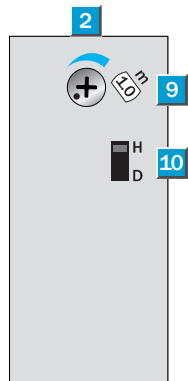

- ② LED signal strength indicator
- ⑨ Adjustment of sensing range
- ⑩ Light/dark selector

Connection type

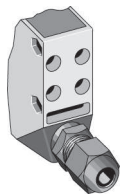

Connection diagram

Cd-167

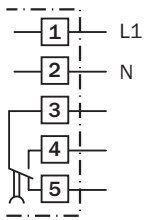

Characteristic curve

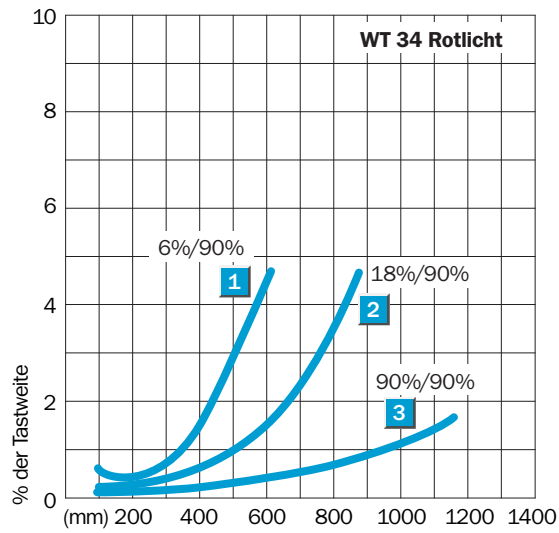

Sensing range diagram

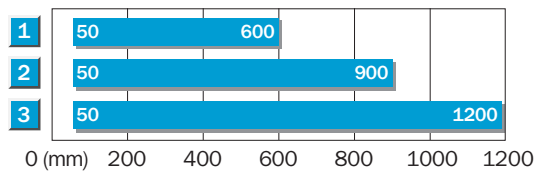

1	Scanning distance on black ⁹⁾
2	Scanning distance on grey ⁹⁾
3	Scanning distance on white ⁹⁾

Recommended accessories

Other models and accessories → www.sick.com/W34

	Brief description	Type	Part no.
Mounting brackets and plates			
	Mounting bracket, Stainless steel (1.4301), mounting hardware included	BEF-WN-W24	2015248

SICK AT A GLANCE

SICK is one of the leading manufacturers of intelligent sensors and sensor solutions for industrial applications. A unique range of products and services creates the perfect basis for controlling processes securely and efficiently, protecting individuals from accidents and preventing damage to the environment.

We have extensive experience in a wide range of industries and understand their processes and requirements. With intelligent sensors, we can deliver exactly what our customers need. In application centers in Europe, Asia and North America, system solutions are tested and optimized in accordance with customer specifications. All this makes us a reliable supplier and development partner.

Comprehensive services complete our offering: SICK LifeTime Services provide support throughout the machine life cycle and ensure safety and productivity.

For us, that is “Sensor Intelligence.”

WORLDWIDE PRESENCE:

Contacts and other locations –www.sick.com