



WTB12C-3P2432A91

W12-3

SMALL PHOTOELECTRIC SENSORS

SICK
Sensor Intelligence.



Illustration may differ



Ordering information

Type	Part no.
WTB12C-3P2432A91	1060222

The timestamp function can only be used with the IO-Link Master from B&R (model X20(c)DS438A)

Other models and accessories → www.sick.com/W12-3

Detailed technical data

Features

Functional principle	Photoelectric proximity sensor
Functional principle detail	Background suppression
Sensing range max.	20 mm ... 350 mm ¹⁾
Sensing range	20 mm ... 350 mm ¹⁾
Emitted beam	
Light source	PinPoint LED ²⁾
Type of light	Visible red light
Light spot size (distance)	Ø 6 mm (200 mm)
Key LED figures	
Wave length	640 nm
Adjustment	IO-Link, Single teach-in button
Pin 2 configuration	External input, Teach-in input, Sender off input, Detection output, logic output

¹⁾ Object with 90% remission (based on standard white, DIN 5033).

²⁾ Average service life: 50,000 h at T_U = +25 °C.

Safety-related parameters

MTTF_D	634 years
DC_{avg}	0 %
T_M (mission time)	20 years

Communication interface

IO-Link	✓, COM2 (38,4 kBaud)
----------------	----------------------

Data transmission rate	COM2 (38,4 kBaud)
Cycle time	2.3 ms
Process data length	16 Bit
Process data structure	Bit 0 = switching signal Q _{L1} Bit 1 = switching signal Q _{L2} Bit 2 ... 15 = measuring value
VendorID	26
DeviceID HEX	0x8000ED
DeviceID DEC	8388845

Electrical data

Supply voltage U_B	10 V DC ... 30 V DC ¹⁾
Ripple	< 5 V _{pp} ²⁾
Current consumption	45 mA ³⁾
Protection class	III
Digital output	
Type	PNP ⁴⁾
Switching mode	Light/dark switching
Signal voltage PNP HIGH/LOW	> U _v - 2,5 V / ca. 0 V
Output current I _{max.}	≤ 100 mA
Response time	⁵⁾
Repeatability (response time)	100 μs ⁶⁾
Switching frequency	1,500 Hz ⁷⁾
Circuit protection	A ⁸⁾ B ⁹⁾ C ¹⁰⁾ D ¹¹⁾
Response time Q/ on Pin 2	200 μs ... 300 μs ^{5) 6)}
Switching frequency Q / to pin 2	≤ 1,500 Hz ¹²⁾

¹⁾ Limit values when operated in short-circuit protected network: max. 8 A.

²⁾ May not fall below or exceed U_v tolerances.

³⁾ Without load.

⁴⁾ Pin 4: This switching output must not be connected to another output.

⁵⁾ Signal transit time with resistive load.

⁶⁾ Valid for Q \ on Pin2, if configured with software.

⁷⁾ With light/dark ratio 1:1.

⁸⁾ A = V_S connections reverse-polarity protected.

⁹⁾ B = inputs and output reverse-polarity protected.

¹⁰⁾ C = interference suppression.

¹¹⁾ D = outputs overcurrent and short-circuit protected.

¹²⁾ With light / dark ratio 1:1, valid for Q \ on Pin2, if configured with software.

Mechanical data

Housing	Rectangular
Dimensions (W x H x D)	15.6 mm x 48.5 mm x 42 mm
Connection	Male connector M12, 4-pin

Material	Housing	Metal, zinc diecast
	Front screen	Plastic, PMMA
Weight		120 g

Ambient data

Enclosure rating	IP66 IP67
Ambient operating temperature	-40 °C ... +60 °C
Ambient temperature, storage	-40 °C ... +75 °C
UL File No.	NRKH.E181493 & NRKH7.E181493

Smart Task

Smart Task name	Timestamp + debouncing
Logic function	Direct AND OR WINDOW Hysteresis
Timer function	Deactivated Switch-on delay Off delay ON and OFF delay Impulse (one shot)
Inverter	Yes
Response time	SIO Direct: 200 µs ... 300 µs ¹⁾ SIO Logic: 700 µs ... 800 µs ²⁾ IOL: --- ³⁾
Repeatability	SIO Direct: 100 µs ¹⁾ SIO Logic: 100 µs ²⁾ IOL: --- ³⁾
Time stamp accuracy	SIO Direct: --- SIO Logic: --- IOL: - 70 ... + 320 µs
Min. Time between two process events (switches)	SIO Direct: 300 µs SIO Logic: 500 µs IOL: 700 ms
Time stamp number buffer	SIO Direct: --- SIO Logic: --- IOL: 8
Max. TimeStamp Range	SIO Direct: --- SIO Logic: --- IOL: 260 ms
Debounce time max.	SIO Direct: --- SIO Logic: 52 ms IOL: 52 ms
Switching signal	
Switching signal Q _{L1}	Switching output

¹⁾ SIO Direct: sensor operation in standard I/O mode without IO-Link communication and without using internal sensor logic or time parameters (set to "direct"/"deactivated").

²⁾ SIO Logic: Sensor operation in standard I/O mode without IO-Link communication. Sensor-internal logic or timing parameters plus Automation Functions used.

³⁾ IOL: Sensor operation with full IO-Link communication and usage of logic, timing and Automation Function parameters.

Switching signal Q _{L2}	Switching output
Measuring value	Timestamp

1) SIO Direct: sensor operation in standard I/O mode without IO-Link communication and without using internal sensor logic or time parameters (set to "direct"/"deactivated").

2) SIO Logic: Sensor operation in standard I/O mode without IO-Link communication. Sensor-internal logic or timing parameters plus Automation Functions used.

3) IOL: Sensor operation with full IO-Link communication and usage of logic, timing and Automation Function parameters.

Diagnosis

Device status	Yes
---------------	-----

Classifications

ECLASS 5.0	27270904
ECLASS 5.1.4	27270904
ECLASS 6.0	27270904
ECLASS 6.2	27270904
ECLASS 7.0	27270904
ECLASS 8.0	27270904
ECLASS 8.1	27270904
ECLASS 9.0	27270904
ECLASS 10.0	27270904
ECLASS 11.0	27270904
ECLASS 12.0	27270903
ETIM 5.0	EC002719
ETIM 6.0	EC002719
ETIM 7.0	EC002719
ETIM 8.0	EC002719
UNSPSC 16.0901	39121528

Adjustments

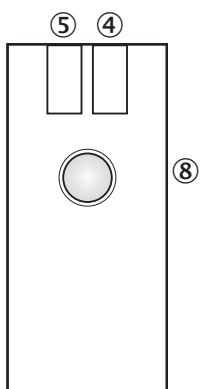

- ④ LED indicator green: Supply voltage active
- ⑤ LED indicator yellow: Status of received light beam
- ⑧ Adjustment sensing range: single teach-in button

Connection type

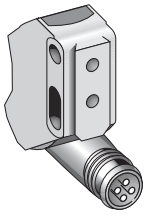

Connection diagram

Cd-367

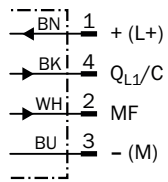

Dimensional drawing (Dimensions in mm (inch))

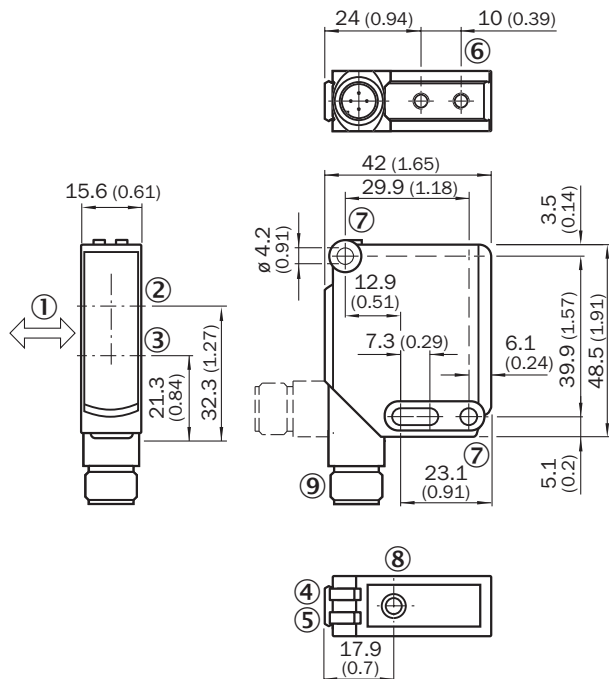

WTB12-3, IO-Link



- ① Standard direction of the material being detected
- ② Optical axis, receiver
- ③ Optical axis, sender
- ④ LED indicator green: Supply voltage active
- ⑤ LED indicator yellow: Status of received light beam
- ⑥ M4 threaded mounting hole, 4 mm deep
- ⑦ Mounting hole, \varnothing 4.2 mm
- ⑧ Adjustment sensing range: single teach-in button
- ⑨ Connection

Recommended accessories

Other models and accessories → www.sick.com/W12-3

	Brief description	Type	Part no.
Connection modules			
	IO-Link V1.1 Class A port, USB2.0 port, optional external power supply 24V / 1A	IOLA2US-01101 (SiLink2 Master)	1061790
	PROFINET IO-Link Master, IO-Link V1.1, Port Class A, power supply via 7/8" cable 24 V / 8 A, fieldbus connection via M12 cable	IOLG2PN-03208R01 (IO-Link Master)	6053253
	<ul style="list-style-type: none"> • Connection type head A: Female connector, M12, 4-pin, straight, A-coded • Connection type head B: Flying leads • Signal type: Sensor/actuator cable • Cable: 5 m, 4-wire, PVC • Description: Sensor/actuator cable, unshielded • Application: Zones with chemicals 	YF2A14-050VB3XLEAX	2096235

Recommended services

Additional services → www.sick.com/W12-3

	Type	Part no.
Function Block Factory		
<ul style="list-style-type: none"> • Description: The Function Block Factory supports common programmable logic controllers (PLCs) from various manufacturers, such as Siemens, Beckhoff, Rockwell Automation and B&R. More information on the FBF can be found <a _blank"="" href="https://fbf.cloud.sick.com target=">here. • Note: You can configure your function block at <a _blank"="" href="https://fbf.cloud.sick.com target=">Function Block Factory. As a login please use your SICK ID. 	Function Block Factory	On request

SICK AT A GLANCE

SICK is one of the leading manufacturers of intelligent sensors and sensor solutions for industrial applications. A unique range of products and services creates the perfect basis for controlling processes securely and efficiently, protecting individuals from accidents and preventing damage to the environment.

We have extensive experience in a wide range of industries and understand their processes and requirements. With intelligent sensors, we can deliver exactly what our customers need. In application centers in Europe, Asia and North America, system solutions are tested and optimized in accordance with customer specifications. All this makes us a reliable supplier and development partner.

Comprehensive services complete our offering: SICK LifeTime Services provide support throughout the machine life cycle and ensure safety and productivity.

For us, that is “Sensor Intelligence.”

WORLDWIDE PRESENCE:

Contacts and other locations –www.sick.com