



# WTB16P-24861120A00

W16

SMALL PHOTOELECTRIC SENSORS

**SICK**  
Sensor Intelligence.



Illustration may differ



### Ordering information

Type	Part no.
WTB16P-24861120A00	1115767

Other models and accessories → [www.sick.com/W16](http://www.sick.com/W16)

### Detailed technical data

#### Features

<b>Functional principle</b>	Photoelectric proximity sensor
<b>Functional principle detail</b>	Background suppression
<b>Sensing range</b>	
Sensing range min.	10 mm
Sensing range max.	1,000 mm
Adjustable switching threshold for background suppression	100 mm ... 1,000 mm
Reference object	Object with 90% remission factor (complies with standard white according to DIN 5033)
Minimum distance between set sensing range and background (black 6% / white 90%)	25 mm, at a distance of 400 mm
Recommended sensing range for the best performance	100 mm ... 400 mm
<b>Emitted beam</b>	
Light source	PinPoint LED
Type of light	Visible red light
Shape of light spot	Point-shaped
Light spot size (distance)	Ø 6 mm (500 mm)
Maximum dispersion of the emitted beam around the standardized transmission axis (squint angle)	< +/- 1.0° (at Ta = +23 °C)

<b>Key LED figures</b>	
Normative reference	EN 62471:2008-09   IEC 62471:2006, modified
LED risk group marking	Free group
Wave length	635 nm
Average service life	100,000 h at $T_a = +25 \text{ }^\circ\text{C}$
<b>Adjustment</b>	
Teach-Turn adjustment	BluePilot: For setting the sensing range
IO-Link	For configuring the sensor parameters and Smart Task functions
<b>Indication</b>	
LED blue	BluePilot: sensing range indicator
LED green	Operating indicator Static on: power on Flashing: IO-Link mode
LED yellow	Status of received light beam Static on: object present Static off: object not present

### Safety-related parameters

<b>MTTF<sub>D</sub></b>	626 years
<b>DC<sub>avg</sub></b>	0%
<b>T<sub>M</sub> (mission time)</b>	20 years (EN ISO 13849, rate of use: 60 %)

### Communication interface

<b>IO-Link</b>	✓, V1.1
Data transmission rate	COM2 (38,4 kBaud)
Cycle time	2.3 ms
Process data length	16 Bit
Process data structure	Bit 0 = switching signal Q <sub>L1</sub> Bit 1 = switching signal Q <sub>L2</sub> Bit 2 ... 15 = empty
VendorID	26
DeviceID HEX	0x80015C
DeviceID DEC	8388956
Compatible master port type	A
SIO mode support	Yes

### Electrical data

<b>Supply voltage U<sub>B</sub></b>	10 V DC ... 30 V DC <sup>1)</sup>
<b>Ripple</b>	≤ 5 V <sub>pp</sub>
<b>Usage category</b>	DC-12 (According to EN 60947-5-2) DC-13 (According to EN 60947-5-2)
<b>Current consumption</b>	≤ 30 mA, without load. At U <sub>B</sub> = 24 V
<b>Protection class</b>	III
<b>Digital output</b>	

<sup>1)</sup> Limit values.

<sup>2)</sup> Signal transit time with resistive load in switching mode.

<sup>3)</sup> With light/dark ratio 1:1.

<sup>4)</sup> This switching output must not be connected to another output.

Number	2 (Complementary)
Type	PNP
Switching mode	Light/dark switching
Signal voltage PNP HIGH/LOW	Approx. $U_B - 2.5 \text{ V} / 0 \text{ V}$
Output current $I_{\text{max}}$	$\leq 100 \text{ mA}$
Circuit protection outputs	Reverse polarity protected Overcurrent and short-circuit protected
Response time	$\leq 500 \mu\text{s}$ <sup>2)</sup>
Repeatability (response time)	150 $\mu\text{s}$
Switching frequency	1,000 Hz <sup>3)</sup>
<b>Pin/Wire assignment</b>	
Function of pin 4/black (BK)	Digital output, light switching, object present → output $Q_{L1}$ HIGH; IO-Link communication C <sup>4)</sup>
Function of pin 4/black (BK) – detail	The pin 4 function of the sensor can be configured, Additional possible settings via IO-Link
Function of pin 2/white (WH)	Digital output, dark switching, object present → output $\bar{Q}_{L1}$ LOW
Function of pin 2/white (WH) – detail	The pin 2 function of the sensor can be configured, Additional possible settings via IO-Link

<sup>1)</sup> Limit values.

<sup>2)</sup> Signal transit time with resistive load in switching mode.

<sup>3)</sup> With light/dark ratio 1:1.

<sup>4)</sup> This switching output must not be connected to another output.

### Mechanical data

<b>Housing</b>	Rectangular
<b>Dimensions (W x H x D)</b>	20 mm x 55.7 mm x 42 mm
<b>Connection</b>	Male connector M12, 4-pin
<b>Material</b>	
Housing	Plastic, VISTAL®
Front screen	Plastic, PMMA
Male connector	Plastic, VISTAL®
<b>Weight</b>	Approx. 50 g
<b>Maximum tightening torque of the fixing screws</b>	1.3 Nm

### Ambient data

<b>Enclosure rating</b>	IP66 (EN 60529) IP67 (EN 60529) IP69 (EN 60529) <sup>1)</sup>
<b>Ambient operating temperature</b>	-40 °C ... +60 °C
<b>Ambient temperature, storage</b>	-40 °C ... +75 °C
<b>Shock resistance</b>	50 g, 11 ms (25 positive and 25 negative shocks per axis, for X, Y, Z axes, 150 shocks in total (EN60068-2-27)) 50 g, 6 ms (5,000 positive and 5,000 negative shocks per axis, for X, Y, Z axes, 30,000 shocks in total (EN60068-2-27))
<b>Vibration resistance</b>	10 Hz ... 2,000 Hz (Amplitude 0.5 mm / 10 g, 20 sweeps per axis, for X, Y, Z axes, 1 octave/min, (EN60068-2-6))
<b>Air humidity</b>	35 % ... 95 %, relative humidity (no condensation)

<sup>1)</sup> Replaces IP69K with ISO 20653: 2013-03.

<b>Electromagnetic compatibility (EMC)</b>	EN 60947-5-2
<b>Resistance to cleaning agent</b>	ECOLAB
<b>UL File No.</b>	NRKH.E181493 & NRKH7.E181493

<sup>1)</sup> Replaces IP69K with ISO 20653: 2013-03.

### Smart Task

<b>Smart Task name</b>	Base logics
<b>Logic function</b>	Direct AND OR Window Hysteresis
<b>Timer function</b>	Deactivated Switch-on delay Off delay ON and OFF delay Impulse (one shot)
<b>Inverter</b>	Yes
<b>Switching frequency</b>	SIO Logic: 800 Hz <sup>1)</sup> IOL: 650 Hz <sup>2)</sup>
<b>Response time</b>	SIO Logic: 600 µs <sup>1)</sup> IOL: 750 µs <sup>2)</sup>
<b>Repeatability</b>	SIO Logic: 300 µs <sup>1)</sup> IOL: 400 µs <sup>2)</sup>
<b>Switching signal</b>	
Switching signal Q <sub>L1</sub>	Switching output
Switching signal $\bar{Q}_{L1}$	Switching output

<sup>1)</sup> Use of Smart Task functions without IO-Link communication (SIO mode).

<sup>2)</sup> Use of Smart Task functions with IO-Link communication function.

### Diagnosis

<b>Device status</b>	Yes
<b>Quality of teach</b>	Yes

### Classifications

<b>ECLASS 5.0</b>	27270904
<b>ECLASS 5.1.4</b>	27270904
<b>ECLASS 6.0</b>	27270904
<b>ECLASS 6.2</b>	27270904
<b>ECLASS 7.0</b>	27270904
<b>ECLASS 8.0</b>	27270904
<b>ECLASS 8.1</b>	27270904
<b>ECLASS 9.0</b>	27270904
<b>ECLASS 10.0</b>	27270904
<b>ECLASS 11.0</b>	27270904
<b>ECLASS 12.0</b>	27270903
<b>ETIM 5.0</b>	EC002719

<b>ETIM 6.0</b>	EC002719
<b>ETIM 7.0</b>	EC002719
<b>ETIM 8.0</b>	EC002719
<b>UNSPSC 16.0901</b>	39121528

### Dimensional drawing (Dimensions in mm (inch))

Dimensional drawing, sensor

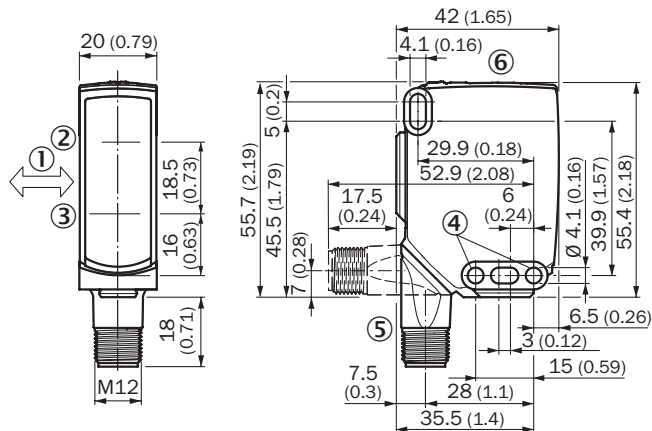

- ① Standard direction of the material being detected
- ② Center of optical axis, sender
- ③ Center of optical axis, receiver
- ④ Mounting hole,  $\varnothing$  4.1 mm
- ⑤ Connection
- ⑥ Display and adjustment elements

### Adjustments

Display and adjustment elements

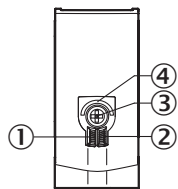

- ① LED indicator green
- ② LED indicator yellow
- ③ Teach-Turn adjustment
- ④ LED blue

### Connection type

M12 male connector, 4-pin

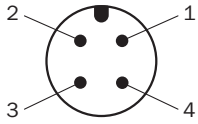

### Connection diagram

Cd-390

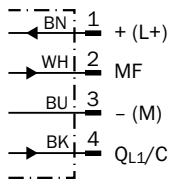

### Truth table

PNP - dark switching  $\bar{Q}$

	Dark switching $\bar{Q}$ (normally closed)	
	Object not present → Output HIGH	Object present → Output LOW
Light receive	✗	✓
Light receive indicator	✗	☉
Load resistance to M	⚠	✗

PNP - light switching Q

	Light switching Q (normally open)	
	Object not present → Output LOW	Object present → Output HIGH
Light receive	✗	✓
Light receive indicator	✗	☉
Load resistance to M	✗	⚠

### Characteristic curve

Minimum distance in mm (y) between the set sensing range and white background (90 % remission)

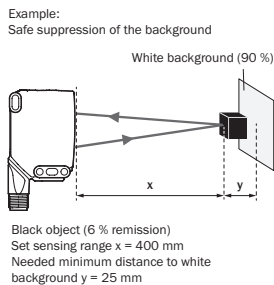
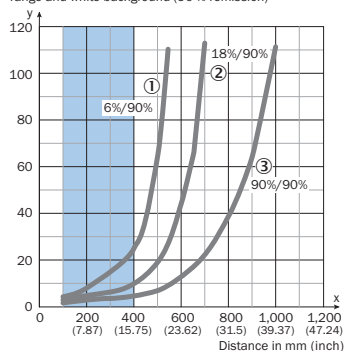

Black object (6 % remission)  
Set sensing range  $x = 400$  mm  
Needed minimum distance to white background  $y = 25$  mm

Recommended sensing range for the best performance

- ① Black object, 6% remission factor
- ② Gray object, 18% remission factor
- ③ White object, 90% remission factor

### Light spot size

WTB16P-xxxxx1xx, WTB16P-xxxxxAxx

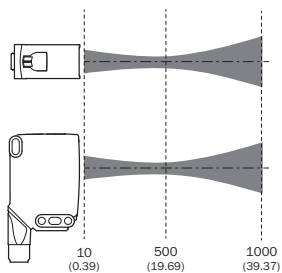
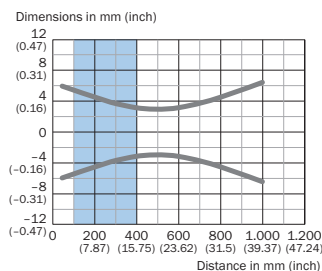

Recommended sensing range for the best performance

### Sensing range diagram

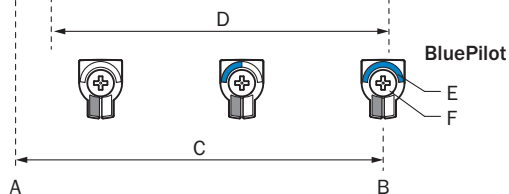
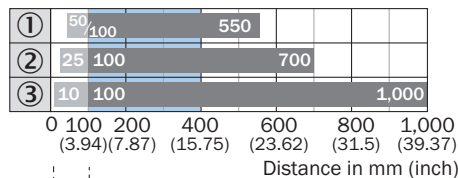



Recommended sensing range for the best performance



1	Black object, 6% remission factor
2	Gray object, 18% remission factor
3	White object, 90% remission factor
A	Sensing range min. in mm
B	Sensing range max. in mm
C	Field of view
D	Adjustable switching threshold for background suppression
E	Sensing range indicator
F	Teach-Turn adjustment

### Recommended accessories

Other models and accessories → [www.sick.com/W16](http://www.sick.com/W16)

	Brief description	Type	Part no.
Universal bar clamp systems			
	Plate N02 for universal clamp bracket, Zinc plated steel (sheet), Zinc die cast (clamping bracket), Universal clamp (5322626), mounting hardware	BEF-KHS-N02	2051608
Mounting brackets and plates			
	Adapter for mounting W16 sensors in existing W14-2/W18-3 installations or L25 sensors in existing L28 installations, plastic, fastening screws included	BEF-AP-W16	2095677
Others			
	<ul style="list-style-type: none"> <li>• <b>Connection type head A:</b> Female connector, M12, 4-pin, straight, A-coded</li> <li>• <b>Connection type head B:</b> Flying leads</li> <li>• <b>Signal type:</b> Sensor/actuator cable</li> <li>• <b>Cable:</b> 5 m, 4-wire, PVC</li> <li>• <b>Description:</b> Sensor/actuator cable, unshielded</li> <li>• <b>Application:</b> Zones with chemicals</li> </ul>	YF2A14-050VB3XLEAX	2096235

## SICK AT A GLANCE

SICK is one of the leading manufacturers of intelligent sensors and sensor solutions for industrial applications. A unique range of products and services creates the perfect basis for controlling processes securely and efficiently, protecting individuals from accidents and preventing damage to the environment.

We have extensive experience in a wide range of industries and understand their processes and requirements. With intelligent sensors, we can deliver exactly what our customers need. In application centers in Europe, Asia and North America, system solutions are tested and optimized in accordance with customer specifications. All this makes us a reliable supplier and development partner.

Comprehensive services complete our offering: SICK LifeTime Services provide support throughout the machine life cycle and ensure safety and productivity.

For us, that is “Sensor Intelligence.”

## WORLDWIDE PRESENCE:

Contacts and other locations –[www.sick.com](http://www.sick.com)