



WTB250-2N2441
W250-2

COMPACT PHOTOELECTRIC SENSORS

SICK
Sensor Intelligence.



Illustration may differ



Ordering information

| Type | Part no. |
|---------------|----------|
| WTB250-2N2441 | 6044679 |

Included in delivery: BEF-W250 (1)

Other models and accessories → www.sick.com/W250-2

Detailed technical data

Features

| | |
|--|--|
| Functional principle | Photoelectric proximity sensor |
| Functional principle detail | Background suppression |
| Dimensions (W x H x D) | 20 mm x 65 mm x 43.9 mm |
| Housing design (light emission) | Rectangular |
| Sensing range max. | 150 mm ... 500 mm ¹⁾ |
| Sensing range | 150 mm ... 500 mm ¹⁾ |
| Focus | Approx. 3° |
| Type of light | Visible red light |
| Light source | LED ²⁾ |
| Light spot size (distance) | Ø 30 mm (500 mm) |
| Angle of dispersion | Approx. 3° |
| Adjustment | Potentiometer, 2 turns ³⁾ Potentiometer, 2 rotations |

¹⁾ Object with 90% remission (based on standard white, DIN 5033).

²⁾ Average service life: 100,000 h at T_J = +25 °C.

³⁾ With position indicator.

Mechanics/electronics

| | |
|--|---|
| Supply voltage U_B | 10 V DC ... 30 V DC ¹⁾ |
| Ripple | < 5 V _{pp} ²⁾ |
| Current consumption | 35 mA ³⁾ |
| Switching output | NPN |
| Switching mode | Light/dark switching |
| Switching mode selector | Selectable via L/D control cable |
| Output current I_{max} | ≤ 100 mA |
| Response time | ≤ 3 ms ⁴⁾ |
| Switching frequency | 160 Hz ⁵⁾ |
| Connection type | Male connector M12, 4-pin ⁶⁾ |
| Circuit protection | A ⁷⁾ B ⁸⁾ C ⁹⁾ D ¹⁰⁾ |
| Protection class | III |
| Weight | 40 g |
| Housing material | Plastic, ABS |
| Optics material | Plastic, PMMA |
| Enclosure rating | IP67 |
| Items supplied | BEF-W250 mounting bracket |
| Electromagnetic compatibility (EMC) | EN 60947-5-2 ¹¹⁾ |
| Ambient operating temperature | -25 °C ... +55 °C |
| Ambient temperature, storage | -40 °C ... +70 °C |
| UL File No. | NRKH2.E300503 & NRKH8.E300503 |

¹⁾ Limit values when operated in short-circuit protected network: max. 8 A.

²⁾ May not fall below or exceed U_V tolerances.

³⁾ Without load.

⁴⁾ Signal transit time with resistive load.

⁵⁾ With light/dark ratio 1:1.

⁶⁾ Rotatable through 90°.

⁷⁾ A = V_S connections reverse-polarity protected.

⁸⁾ B = inputs and output reverse-polarity protected.

⁹⁾ C = interference suppression.

¹⁰⁾ D = outputs overcurrent and short-circuit protected.

¹¹⁾ The AC/DC devices comply with the Radio Safety Requirements for the industrial sector (Radio Safety Class A). They may cause radio interference if used in a residential area.

Safety-related parameters

| | |
|-------------------------|-----------|
| MTTF_D | 536 years |
| DC_{avg} | 0 % |

Classifications

| | |
|---------------------|----------|
| ECLASS 5.0 | 27270904 |
| ECLASS 5.1.4 | 27270904 |
| ECLASS 6.0 | 27270904 |

| | |
|-----------------------|----------|
| ECLASS 6.2 | 27270904 |
| ECLASS 7.0 | 27270904 |
| ECLASS 8.0 | 27270904 |
| ECLASS 8.1 | 27270904 |
| ECLASS 9.0 | 27270904 |
| ECLASS 10.0 | 27270904 |
| ECLASS 11.0 | 27270904 |
| ECLASS 12.0 | 27270903 |
| ETIM 5.0 | EC002719 |
| ETIM 6.0 | EC002719 |
| ETIM 7.0 | EC002719 |
| ETIM 8.0 | EC002719 |
| UNSPSC 16.0901 | 39121528 |

Dimensional drawing (Dimensions in mm (inch))

WTB250-2, DC, connector

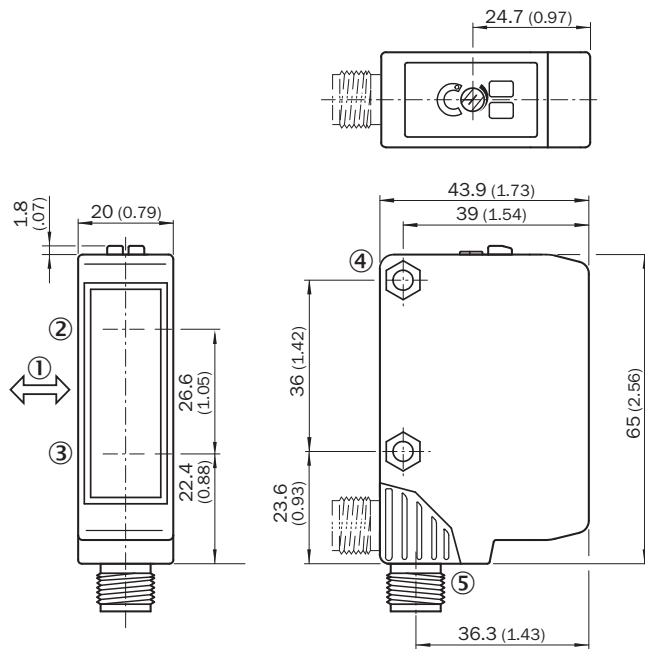

- ① Standard direction of the material being detected
- ② Axis of sender
- ③ Axis of receiver
- ④ Mounting hole \varnothing 4.2 mm, for M4 hexagon nuts on both sides
- ⑤ Connector M12, 4-pin: Connector position rotatable by 90° (V>H); V: Vertikal final position; H: Horizontal final position, can be locked with slider

Adjustments

WTB250-2

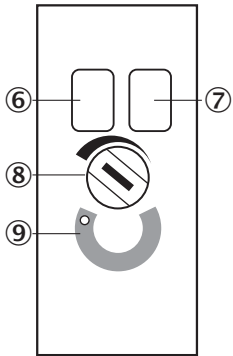

- ⑥ LED indicator green: Stability indicator
- ⑦ LED indicator yellow: Status of received light beam
- ⑧ Sensing range adjustment: potentiometer
- ⑨ Position indicator for sensitivity setting (270°)

Connection diagram

Cd-087

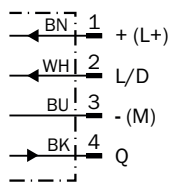

Characteristic curve

WTB250-2, 500 mm

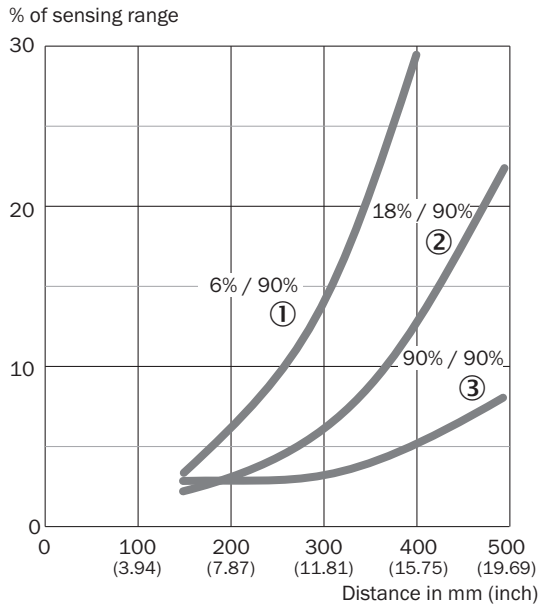

- ① Sensing range on black, white background
- ② Sensing range on gray, white background
- ③ Sensing range on white, white background

Sensing range diagram

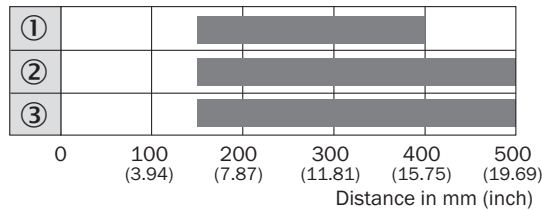

WTB250-2, 500 mm



- Sensing range
- ① Sensing range on black, white background
- ② Sensing range on gray, white background
- ③ Sensing range on white, white background

Recommended accessories

Other models and accessories → www.sick.com/W250-2

| | Brief description | Type | Part no. |
|---|---|--------------------|----------|
| Others | | | |
|  | <ul style="list-style-type: none"> • Connection type head A: Female connector, M12, 4-pin, straight, A-coded • Connection type head B: Flying leads • Signal type: Sensor/actuator cable • Cable: 5 m, 4-wire, PVC • Description: Sensor/actuator cable, unshielded • Application: Zones with chemicals | YF2A14-050VB3XLEAX | 2096235 |
|  | <ul style="list-style-type: none"> • Connection type head A: Male connector, M12, 4-pin, straight, A-coded • Description: Unshielded • Connection systems: Screw-type terminals • Permitted cross-section: ≤ 0.75 mm² | STE-1204-G | 6009932 |

SICK AT A GLANCE

SICK is one of the leading manufacturers of intelligent sensors and sensor solutions for industrial applications. A unique range of products and services creates the perfect basis for controlling processes securely and efficiently, protecting individuals from accidents and preventing damage to the environment.

We have extensive experience in a wide range of industries and understand their processes and requirements. With intelligent sensors, we can deliver exactly what our customers need. In application centers in Europe, Asia and North America, system solutions are tested and optimized in accordance with customer specifications. All this makes us a reliable supplier and development partner.

Comprehensive services complete our offering: SICK LifeTime Services provide support throughout the machine life cycle and ensure safety and productivity.

For us, that is “Sensor Intelligence.”

WORLDWIDE PRESENCE:

Contacts and other locations –www.sick.com