



# WTB4FP-32167120A00

W4

MINIATURE PHOTOELECTRIC SENSORS

**SICK**  
Sensor Intelligence.



Illustration may differ

### Ordering information

| Type               | Part no. |
|--------------------|----------|
| WTB4FP-32167120A00 | 1120894  |

Other models and accessories → [www.sick.com/W4](http://www.sick.com/W4)



### Detailed technical data

#### Features

|   |   |
|---|---|
| <b>Functional principle</b>   | Photoelectric proximity sensor  |
| <b>Functional principle detail</b>  | Background suppression  |
| <b>Sensing range</b>  |   |
| Sensing range min.  | 4 mm  |
| Sensing range max.  | 220 mm  |
| Adjustable switching threshold for background suppression                                       | 15 mm ... 220 mm  |
| Reference object  | Object with 90% remission factor (complies with standard white according to DIN 5033) |
| Minimum distance between set sensing range and background (black 6% / white 90%)                | 3 mm, at a distance of 80 mm  |
| Recommended sensing range for the best performance  | 40 mm ... 140 mm  |
| <b>Emitted beam</b>   |   |
| Light source  | PinPoint LED  |
| Type of light   | Visible red light   |
| Shape of light spot   | Point-shaped  |
| Light spot size (distance)  | Ø 4.2 mm (130 mm)   |
| Maximum dispersion of the emitted beam around the standardized transmission axis (squint angle) | < +/- 1.5° (at Ta = +23 °C)   |

|  |  |  |
|--|--|--|
| <b>Key LED figures</b>                       |  |  |
| Normative reference                          | EN 62471:2008-09   IEC 62471:2006, modified  |  |
| LED risk group marking                       | Free group   |  |
| Wave length                                  | 635 nm   |  |
| Average service life                         | 100,000 h at T <sub>a</sub> = +25 °C   |  |
| <b>Smallest detectable object (MDO) typ.</b> |  | 0.2 mm (At 130 mm distance (object with remission factor of 90% (complies with standard white according to DIN 5033))) |
| <b>Adjustment</b>                            |  |  |
| Teach-Turn adjustment                        | BluePilot: For setting the sensing range   |  |
| IO-Link                                      | For configuring the sensor parameters and Smart Task functions                               |  |
| <b>Indication</b>                            |  |  |
| LED blue                                     | BluePilot: sensing range indicator   |  |
| LED green                                    | Operating indicator<br>Static on: power on<br>Flashing: IO-Link mode                         |  |
| LED yellow                                   | Status of received light beam<br>Static on: object present<br>Static off: object not present |  |

#### Safety-related parameters

|                                     |  |
|-------------------------------------|--|
| <b>MTTF<sub>D</sub></b>             | 642 years                                  |
| <b>DC<sub>avg</sub></b>             | 0 %  |
| <b>T<sub>M</sub> (mission time)</b> | 20 years (EN ISO 13849, rate of use: 60 %) |

#### Communication interface

|                             |  |
|-----------------------------|--|
| <b>IO-Link</b>              | ✓, IO-Link V1.1  |
| Data transmission rate      | COM2 (38,4 kBaud)  |
| Cycle time                  | 2.3 ms   |
| Process data length         | 16 Bit   |
| Process data structure      | Bit 0 = switching signal Q <sub>L1</sub><br>Bit 1 = switching signal Q <sub>L2</sub><br>Bit 2 ... 15 = Current receiver level (live) |
| VendorID                    | 26   |
| DeviceID HEX                | 0x8002AC   |
| DeviceID DEC                | 8389292  |
| Compatible master port type | A  |
| SIO mode support            | Yes  |

#### Electrical data

|                                     |  |
|-------------------------------------|--|
| <b>Supply voltage U<sub>B</sub></b> | 10 V DC ... 30 V DC <sup>1)</sup>                                      |
| <b>Ripple</b>                       | ≤ 5 V <sub>pp</sub>  |
| <b>Usage category</b>               | DC-12 (According to EN 60947-5-2)<br>DC-13 (According to EN 60947-5-2) |

<sup>1)</sup> Limit values.

<sup>2)</sup> Signal transit time with resistive load in switching mode.

<sup>3)</sup> With light/dark ratio 1:1.

<sup>4)</sup> This switching output must not be connected to another output.

|                                       |  |
|---------------------------------------|--|
| <b>Current consumption</b>            | ≤ 25 mA, without load. At U <sub>B</sub> = 24 V  |
| <b>Protection class</b>               | III  |
| <b>Digital output</b>                 |  |
| Number                                | 1  |
| Type                                  | Push-pull: PNP/NPN   |
| Switching mode                        | Light switching  |
| Signal voltage PNP HIGH/LOW           | Approx. U <sub>B</sub> -2.5 V / 0 V  |
| Signal voltage NPN HIGH/LOW           | Approx. U <sub>B</sub> / < 2.5 V   |
| Output current I <sub>max.</sub>      | ≤ 100 mA   |
| Circuit protection outputs            | Reverse polarity protected<br>Overcurrent protected<br>Short-circuit protected                                       |
| Response time                         | ≤ 500 μs <sup>2)</sup>   |
| Repeatability (response time)         | 150 μs   |
| Switching frequency                   | 1,000 Hz <sup>3)</sup>   |
| <b>Pin/Wire assignment</b>            |  |
| Function of pin 4/black (BK)          | Digital output, light switching, object present → output Q <sub>L1</sub> HIGH; IO-Link communication C <sup>4)</sup> |
| Function of pin 4/black (BK) – detail | The pin 4 function of the sensor can be configured, Additional possible settings via IO-Link                         |
| Function of pin 2/white (WH)          | Digital input, teach, HIGH active  |
| Function of pin 2/white (WH) – detail | The pin 2 function of the sensor can be configured, Additional possible settings via IO-Link                         |

<sup>1)</sup> Limit values.

<sup>2)</sup> Signal transit time with resistive load in switching mode.

<sup>3)</sup> With light/dark ratio 1:1.

<sup>4)</sup> This switching output must not be connected to another output.

## Mechanical data

|   |   |
|---|---|
| <b>Housing</b>  | Rectangular                                 |
| <b>Design detail</b>                                  | Flat  |
| <b>Dimensions (W x H x D)</b>                         | 16 mm x 40.1 mm x 12.1 mm                   |
| <b>Connection</b>                                     | Cable with M8 male connector, 4-pin, 110 mm |
| <b>Connection detail</b>                              |   |
| Deep-freeze property                                  | Do not bend below 0 °C                      |
| Conductor size  | 0.14 mm <sup>2</sup>                        |
| Cable diameter  | Ø 3.4 mm                                    |
| Length of cable (L)                                   | 77 mm                                       |
| <b>Material</b>                                       |   |
| Housing   | Plastic, VISTAL®                            |
| Front screen  | Plastic, PMMA                               |
| Cable   | Plastic, PVC                                |
| Male connector  | Plastic, VISTAL®                            |
| <b>Weight</b>   | Approx. 30 g                                |
| <b>Maximum tightening torque of the fixing screws</b> | 0.4 Nm                                      |

## Ambient data

|  |   |
|--|---|
| <b>Enclosure rating</b>                    | IP66 (EN 60529)<br>IP67 (EN 60529)  |
| <b>Ambient operating temperature</b>       | -40 °C ... +60 °C   |
| <b>Ambient temperature, storage</b>        | -40 °C ... +75 °C   |
| <b>Typ. Ambient light immunity</b>         | Artificial light: ≤ 50,000 lx<br>Sunlight: ≤ 50,000 lx  |
| <b>Shock resistance</b>                    | 30 g, 11 ms (3 positive and 3 negative shocks along X, Y, Z axes, 18 total shocks (EN60068-2-27)) |
| <b>Vibration resistance</b>                | 10 Hz ... 1,000 Hz (Amplitude 1 mm, 3 x 30 min (EN60068-2-6))                                     |
| <b>Air humidity</b>                        | 35 % ... 95 %, relative humidity (no condensation)  |
| <b>Electromagnetic compatibility (EMC)</b> | EN 60947-5-2  |
| <b>Resistance to cleaning agent</b>        | ECOLAB  |
| <b>UL File No.</b>                         | NRKH.E181493 & NRKH7.E181493  |

## Smart Task

|                                  |   |
|----------------------------------|---|
| <b>Smart Task name</b>           | Base logics   |
| <b>Logic function</b>            | Direct<br>AND<br>OR   |
| <b>Timer function</b>            | Deactivated<br>Switch-on delay<br>Off delay<br>ON and OFF delay<br>Impulse (one shot) |
| <b>Inverter</b>                  | Yes   |
| <b>Switching frequency</b>       | SIO Logic: 900 Hz <sup>1)</sup><br>IOL: 800 Hz <sup>2)</sup>                          |
| <b>Response time</b>             | SIO Logic: 550 μs <sup>1)</sup><br>IOL: 600 μs <sup>2)</sup>                          |
| <b>Repeatability</b>             | SIO Logic: 200 μs <sup>1)</sup><br>IOL: 250 μs <sup>2)</sup>                          |
| <b>Switching signal</b>          |   |
| Switching signal Q <sub>L1</sub> | Switching output  |
| Switching signal $\bar{Q}_{L1}$  | Switching output  |

<sup>1)</sup> Use of Smart Task functions without IO-Link communication (SIO mode).

<sup>2)</sup> Use of Smart Task functions with IO-Link communication function.

## Diagnosis

|  |                                      |
|--|--------------------------------------|
| <b>Device temperature</b>                          |                                      |
| Measuring range                                    | Very cold, cold, moderate, warm, hot |
| <b>Device status</b>                               | Yes                                  |
| <b>Detailed device status</b>                      | Yes                                  |
| <b>Operating hour counter</b>                      | Yes                                  |
| <b>Operating hours counter with reset function</b> | Yes                                  |
| <b>Quality of teach</b>                            | Yes                                  |

## Classifications

|                       |          |
|-----------------------|----------|
| <b>ECLASS 5.0</b>     | 27270904 |
| <b>ECLASS 5.1.4</b>   | 27270904 |
| <b>ECLASS 6.0</b>     | 27270904 |
| <b>ECLASS 6.2</b>     | 27270904 |
| <b>ECLASS 7.0</b>     | 27270904 |
| <b>ECLASS 8.0</b>     | 27270904 |
| <b>ECLASS 8.1</b>     | 27270904 |
| <b>ECLASS 9.0</b>     | 27270904 |
| <b>ECLASS 10.0</b>    | 27270904 |
| <b>ECLASS 11.0</b>    | 27270904 |
| <b>ECLASS 12.0</b>    | 27270903 |
| <b>ETIM 5.0</b>       | EC002719 |
| <b>ETIM 6.0</b>       | EC002719 |
| <b>ETIM 7.0</b>       | EC002719 |
| <b>ETIM 8.0</b>       | EC002719 |
| <b>UNSPSC 16.0901</b> | 39121528 |

## Adjustments

Display and adjustment elements

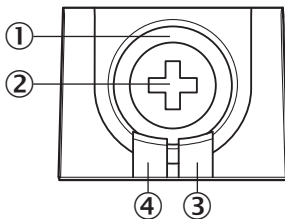

- ① LED blue
- ② Teach-Turn adjustment
- ③ LED yellow
- ④ LED green

## Connection type

Male connector M8, 4-pin

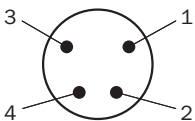

## Connection diagram

Cd-506

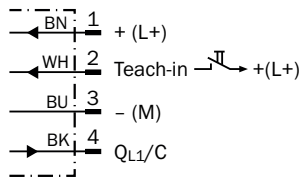

## Truth table

Push-pull: PNP/NPN – dark switching  $\bar{Q}$

|                         | Dark switching $\bar{Q}$ (normally closed (upper switch), normally open (lower switch)) |                             |
|-------------------------|---|-----------------------------|
|                         | Object not present → Output HIGH  | Object present → Output LOW |
| Light receive           | ✗   | ✓                           |
| Light receive indicator | ✗   | ☉                           |
| Load resistance to L+   | ✗   | ⚠                           |
| Load resistance to M    | ⚠   | ✗                           |
|                         |   |                             |

Push-pull: PNP/NPN - light switching Q

|                         | Light switching Q (normally open (upper switch), normally closed (lower switch)) |                              |
|-------------------------|--|------------------------------|
|                         | Object not present → Output LOW  | Object present → Output HIGH |
| Light receive           | ✗  | ✓                            |
| Light receive indicator | ✗  | ☉                            |
| Load resistance to L+   | ⚠  | ✗                            |
| Load resistance to M    | ✗  | ⚠                            |
|                         |  |                              |

### Characteristic curve

Minimum distance in mm (y) between the set sensing range and white background (90 % remission)

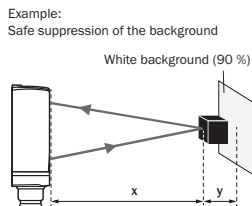
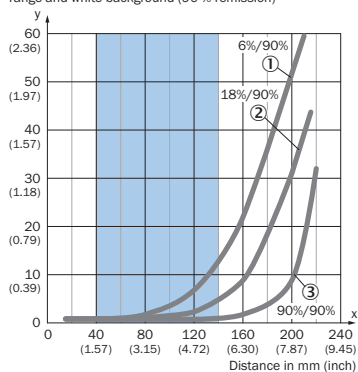

Black object (6 % remission)  
 Set sensing range  $x = 120$  mm  
 Needed minimum distance to white background  $y = 7$  mm

Recommended sensing range for the best performance

- ① Black object, 6% remission factor
- ② Gray object, 18% remission factor
- ③ White object, 90% remission factor

### Light spot size

Dimensions in mm (inch)

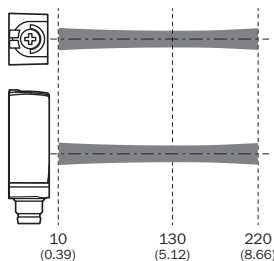
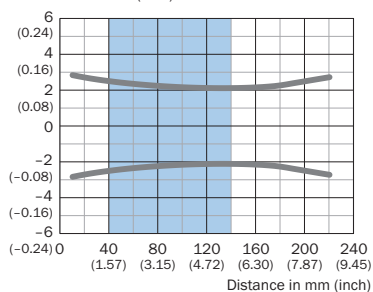

Recommended sensing range for the best performance



### Sensing range diagram

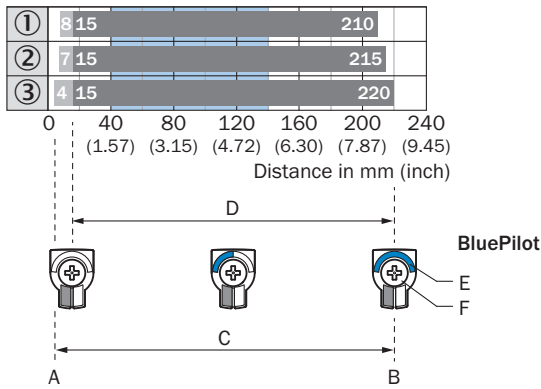

- A = Sensing range min. in mm
- B = Sensing range max. in mm
- C = Viewing range
- D = Adjustable switching threshold for background suppression
- E = Sensing range indicator
- F = Teach-Turn adjustment

■ Recommended sensing range for the best performance

- ① Black object, 6% remission factor
- ② Gray object, 18% remission factor
- ③ White object, 90% remission factor

Dimensional drawing (Dimensions in mm (inch))

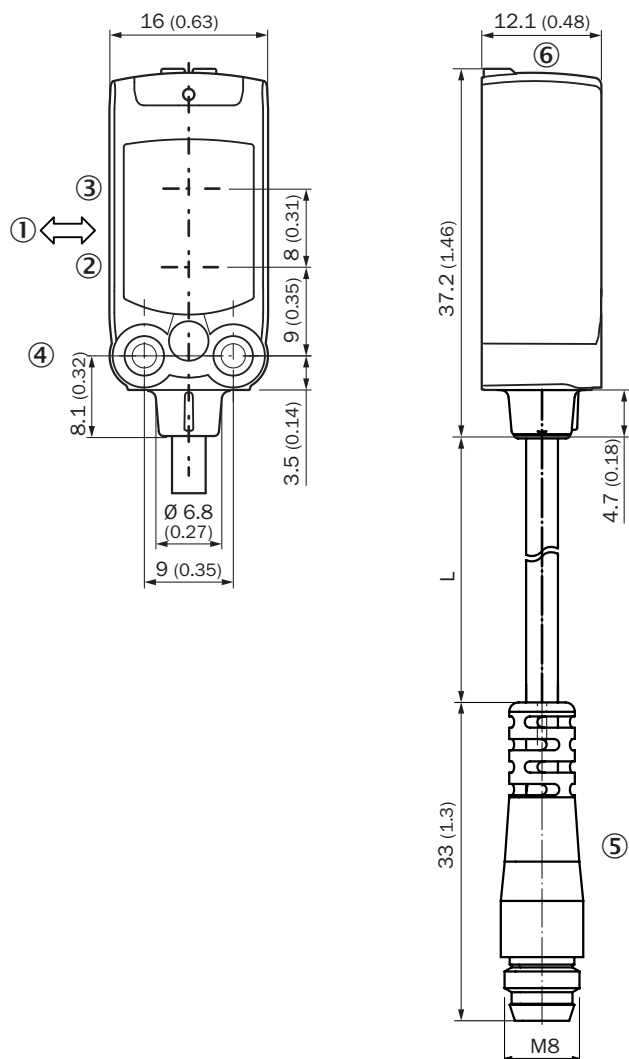





For length of cable (L), see technical data

- ① Standard direction of the material being detected
- ② Center of optical axis, sender
- ③ Center of optical axis, receiver
- ④ M3 mounting hole
- ⑤ Cable with connector M8
- ⑥ Display and adjustment elements

Recommended accessories

Other models and accessories → [www.sick.com/W4](http://www.sick.com/W4)

|   | Brief description  | Type     | Part no. |
|---|--|----------|----------|
| Mounting brackets and plates  |  |          |          |
|  | Mounting bracket for wall mounting, Stainless steel 1.4571, mounting hardware included | BEF-W4-A | 2051628  |

|   | Brief description   | Type               | Part no. |
|---|---|--------------------|----------|
| Others  |   |                    |          |
|  | <ul style="list-style-type: none"> <li>• <b>Connection type head A:</b> Male connector, M12, 4-pin, straight, A-coded</li> <li>• <b>Description:</b> Unshielded</li> <li>• <b>Connection systems:</b> Screw-type terminals</li> <li>• <b>Permitted cross-section:</b> ≤ 0.75 mm<sup>2</sup></li> </ul>  | STE-1204-G         | 6009932  |
|  | <ul style="list-style-type: none"> <li>• <b>Connection type head A:</b> Female connector, M12, 4-pin, straight, A-coded</li> <li>• <b>Connection type head B:</b> Flying leads</li> <li>• <b>Signal type:</b> Sensor/actuator cable</li> <li>• <b>Cable:</b> 5 m, 4-wire, PVC</li> <li>• <b>Description:</b> Sensor/actuator cable, unshielded</li> <li>• <b>Application:</b> Zones with chemicals</li> </ul> | YF2A14-050VB3XLEAX | 2096235  |
|  | <ul style="list-style-type: none"> <li>• <b>Connection type head A:</b> Male connector, M8, 4-pin, straight, A-coded</li> <li>• <b>Description:</b> Unshielded</li> <li>• <b>Connection systems:</b> Screw-type terminals</li> <li>• <b>Permitted cross-section:</b> 0.14 mm<sup>2</sup> ... 0.5 mm<sup>2</sup></li> </ul>  | STE-0804-G         | 6037323  |

## SICK AT A GLANCE

SICK is one of the leading manufacturers of intelligent sensors and sensor solutions for industrial applications. A unique range of products and services creates the perfect basis for controlling processes securely and efficiently, protecting individuals from accidents and preventing damage to the environment.

We have extensive experience in a wide range of industries and understand their processes and requirements. With intelligent sensors, we can deliver exactly what our customers need. In application centers in Europe, Asia and North America, system solutions are tested and optimized in accordance with customer specifications. All this makes us a reliable supplier and development partner.

Comprehensive services complete our offering: SICK LifeTime Services provide support throughout the machine life cycle and ensure safety and productivity.

For us, that is “Sensor Intelligence.”

## WORLDWIDE PRESENCE:

Contacts and other locations –[www.sick.com](http://www.sick.com)