



WTB4FT-32862120A00

W4

MINIATURE PHOTOELECTRIC SENSORS

SICK
Sensor Intelligence.



Illustration may differ

Ordering information

Type	Part no.
WTB4FT-32862120A00	1140923

Other models and accessories → www.sick.com/W4



Detailed technical data

Features

Functional principle	Photoelectric proximity sensor
Functional principle detail	Background suppression, DoubleLine
Sensing range	
Sensing range min.	7 mm
Sensing range max.	120 mm
Adjustable switching threshold for background suppression	15 mm ... 120 mm
Reference object	Object with 90% remission factor (complies with standard white according to DIN 5033)
Minimum distance between set sensing range and background (black 6% / white 90%)	1 mm, at a distance of 50 mm
Recommended sensing range for the best performance	30 mm ... 80 mm
Emitted beam	
Light source	PinPoint LED
Type of light	Visible red light
Shape of light spot	Line-shaped, two parallel line-shaped light spots
Light spot size (distance)	1.2 mm x 17 mm (50 mm)
Maximum dispersion of the emitted beam around the standardized transmission axis (squint angle)	< +/- 1.5° (at Ta = +23 °C)

Key LED figures		
Normative reference	EN 62471:2008-09 IEC 62471:2006, modified	
LED risk group marking	Free group	
Wave length	635 nm	
Average service life	100,000 h at $T_a = +25 \text{ }^\circ\text{C}$	
Smallest detectable object (MDO) typ.		1 mm (At 50 mm distance (object with 90% remission (complies with standard white according to DIN 5033)))
Adjustment		
Teach-Turn adjustment	BluePilot: For setting the sensing range	
IO-Link	For configuring the sensor parameters and Smart Task functions	
Indication		
LED blue	BluePilot: sensing range indicator	
LED green	Operating indicator Static on: power on Flashing: IO-Link mode	
LED yellow	Status of received light beam Static on: object present Static off: object not present	
Special applications		Detecting flat objects, Detecting objects wrapped in film, Detecting perforated objects, Detecting uneven, shiny objects

Safety-related parameters

MTTF_D	661 years
DC_{avg}	0 %
T_M (mission time)	20 years (EN ISO 13849, rate of use: 60 %)

Communication interface

IO-Link	✓, IO-Link V1.1
Data transmission rate	COM2 (38,4 kBaud)
Cycle time	2.3 ms
Process data length	16 Bit
Process data structure	Bit 0 = switching signal Q _{L1} Bit 1 = switching signal Q _{L2} Bit 2 ... 15 = Current receiver level (live)
VendorID	26
DeviceID HEX	0x80036C
DeviceID DEC	8389484
Compatible master port type	A
SIO mode support	Yes

Electrical data

Supply voltage U_B	10 V DC ... 30 V DC ¹⁾
Ripple	≤ 5 V _{pp}

¹⁾ Limit values.

²⁾ Signal transit time with resistive load in switching mode.

³⁾ With light/dark ratio 1:1.

⁴⁾ This switching output must not be connected to another output.

Usage category	DC-12 (According to EN 60947-5-2) DC-13 (According to EN 60947-5-2)
Current consumption	≤ 25 mA, without load. At $U_B = 24\text{ V}$
Protection class	III
Digital output	
Number	2 (Complementary)
Type	PNP
Switching mode	Light/dark switching
Signal voltage PNP HIGH/LOW	Approx. $U_B - 2.5\text{ V} / 0\text{ V}$
Output current I_{max}	≤ 100 mA
Circuit protection outputs	Reverse polarity protected Overcurrent protected Short-circuit protected
Response time	≤ 1,000 μs ²⁾
Repeatability (response time)	240 μs
Switching frequency	500 Hz ³⁾
Pin/Wire assignment	
Function of pin 4/black (BK)	Digital output, dark switching, object present → output \bar{Q}_{L1} LOW; IO-Link communication C ⁴⁾
Function of pin 4/black (BK) – detail	The pin 4 function of the sensor can be configured, Additional possible settings via IO-Link
Function of pin 2/white (WH)	Digital output, light switching, object present → output Q_{L1} HIGH
Function of pin 2/white (WH) – detail	The pin 2 function of the sensor can be configured, Additional possible settings via IO-Link

¹⁾ Limit values.

²⁾ Signal transit time with resistive load in switching mode.

³⁾ With light/dark ratio 1:1.

⁴⁾ This switching output must not be connected to another output.

Mechanical data

Housing	Rectangular
Design detail	Flat
Dimensions (W x H x D)	16 mm x 40.1 mm x 12.1 mm
Connection	Cable with M8 male connector, 4-pin, 110 mm
Connection detail	
Deep-freeze property	Do not bend below 0 °C
Conductor size	0.14 mm ²
Cable diameter	Ø 3.4 mm
Length of cable (L)	77 mm
Material	
Housing	Plastic, VISTAL®
Front screen	Plastic, PMMA
Cable	Plastic, PVC
Male connector	Plastic, VISTAL®
Weight	Approx. 30 g
Maximum tightening torque of the fixing screws	0.4 Nm

Ambient data

Enclosure rating	IP66 (EN 60529) IP67 (EN 60529)
Ambient operating temperature	-40 °C ... +60 °C
Ambient temperature, storage	-40 °C ... +75 °C
Typ. Ambient light immunity	Artificial light: ≤ 50,000 lx Sunlight: ≤ 50,000 lx
Shock resistance	30 g, 11 ms (3 positive and 3 negative shocks along X, Y, Z axes, 18 total shocks (EN60068-2-27))
Vibration resistance	10 Hz ... 1,000 Hz (Amplitude 1 mm, 3 x 30 min (EN60068-2-6))
Air humidity	35 % ... 95 %, relative humidity (no condensation)
Electromagnetic compatibility (EMC)	EN 60947-5-2
Resistance to cleaning agent	ECOLAB
UL File No.	NRKH.E181493 & NRKH7.E181493

Smart Task

Smart Task name	Base logics
Logic function	Direct AND OR
Timer function	Deactivated Switch-on delay Off delay ON and OFF delay Impulse (one shot)
Inverter	Yes
Switching frequency	SIO Logic: 450 Hz ¹⁾ IOL: 450 Hz ²⁾
Response time	SIO Logic: 1100 μs ¹⁾ IOL: 1100 μs ²⁾
Repeatability	SIO Logic: 500 μs ¹⁾ IOL: 550 μs ²⁾
Switching signal	
Switching signal Q _{L1}	Switching output
Switching signal \bar{Q}_{L1}	Switching output

¹⁾ Use of Smart Task functions without IO-Link communication (SIO mode).

²⁾ Use of Smart Task functions with IO-Link communication function.

Diagnosis

Device temperature	
Measuring range	Very cold, cold, moderate, warm, hot
Device status	Yes
Detailed device status	Yes
Operating hour counter	Yes
Operating hours counter with reset function	Yes
Quality of teach	Yes

Classifications

ECLASS 5.0	27270904
ECLASS 5.1.4	27270904
ECLASS 6.0	27270904
ECLASS 6.2	27270904
ECLASS 7.0	27270904
ECLASS 8.0	27270904
ECLASS 8.1	27270904
ECLASS 9.0	27270904
ECLASS 10.0	27270904
ECLASS 11.0	27270904
ECLASS 12.0	27270903
ETIM 5.0	EC002719
ETIM 6.0	EC002719
ETIM 7.0	EC002719
ETIM 8.0	EC002719
UNSPSC 16.0901	39121528

Adjustments

Display and adjustment elements

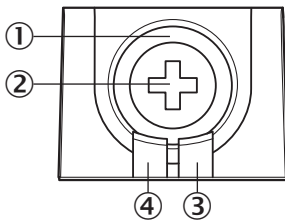

- ① LED blue
- ② Teach-Turn adjustment
- ③ LED yellow
- ④ LED green

Connection type

Male connector M8, 4-pin

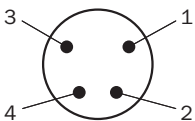

Connection diagram

Cd-490

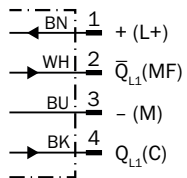

Truth table

PNP - light switching

	Light switching Q (normally open (upper switch), normally closed (lower switch))	
	Object not present → Output LOW	Object present → Output HIGH
Light receive	✘	✔
Light receive indicator	✘	☀
Load resistance to M	✘	⚠

PNP - dark switching

	Dark switching \bar{Q} (normally closed (upper switch), normally open (lower switch))	
	Object not present → Output HIGH	Object present → Output LOW
Light receive	✘	✔
Light receive indicator	✘	☀
Load resistance to M	⚠	✘

Characteristic curve

Minimum distance in mm (y) between the set sensing range and white background (90 % remission)

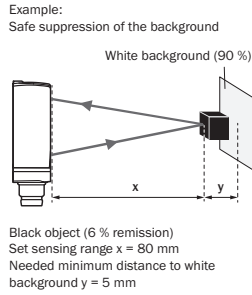
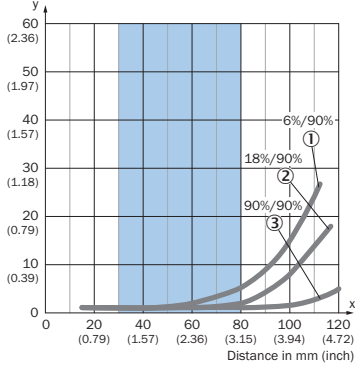

Recommended sensing range for the best performance

- ① Black object, 6% remission factor
- ② Gray object, 18% remission factor
- ③ White object, 90% remission factor

Light spot size

Vertical

Dimensions in mm (inch)

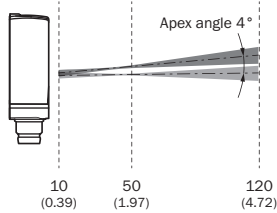
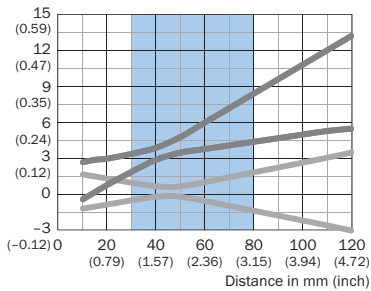

Recommended sensing range for the best performance

Horizontal

Dimensions in mm (inch)

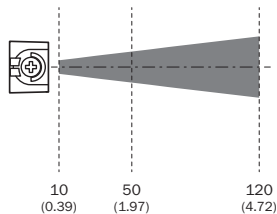
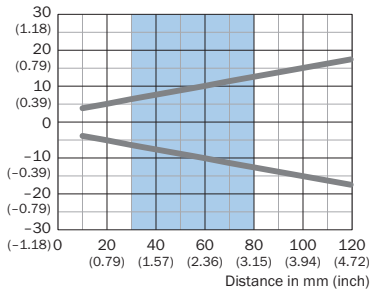

Recommended sensing range for the best performance

Sensing range diagram

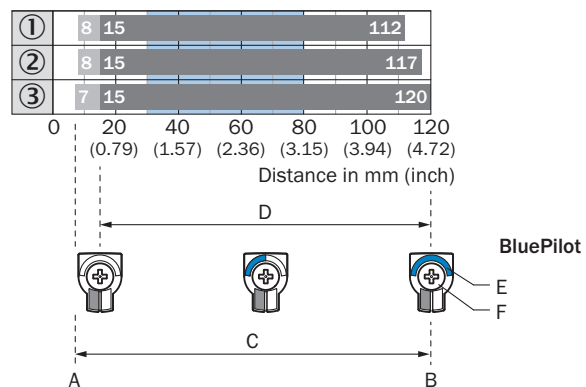

A = Sensing range min. in mm
 B = Sensing range max. in mm
 C = Viewing range
 D = Adjustable switching threshold for background suppression
 E = Sensing range indicator
 F = Teach-Turn adjustment

Recommended sensing range for the best performance

- ① Black object, 6% remission factor
- ② Gray object, 18% remission factor
- ③ White object, 90% remission factor

Dimensional drawing (Dimensions in mm (inch))

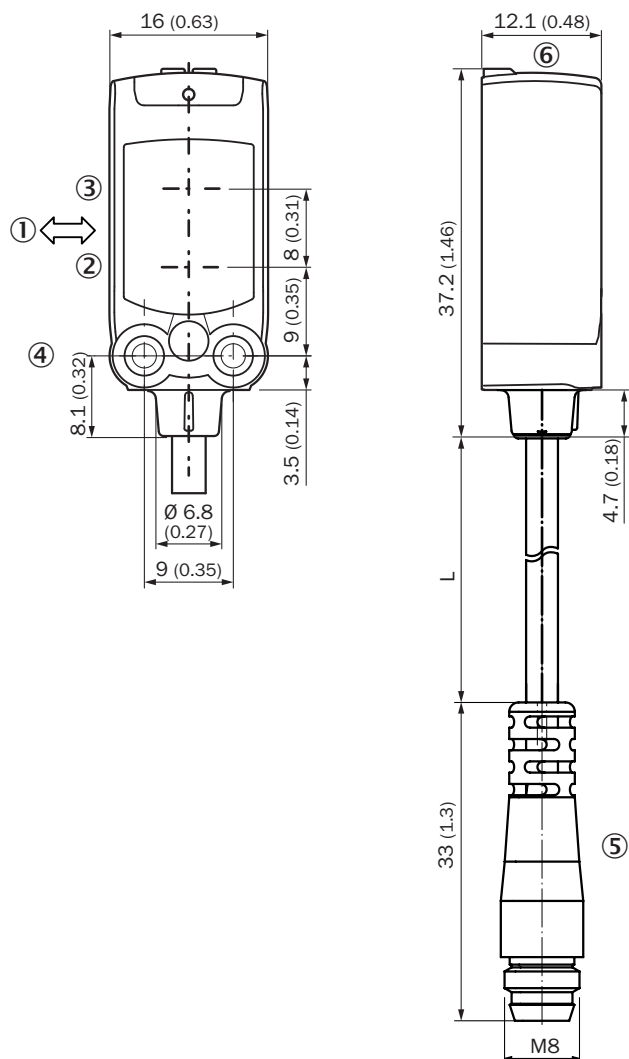



For length of cable (L), see technical data

- ① Standard direction of the material being detected
- ② Center of optical axis, sender
- ③ Center of optical axis, receiver
- ④ M3 mounting hole
- ⑤ Cable with connector M8
- ⑥ Display and adjustment elements

Recommended accessories

Other models and accessories → www.sick.com/W4

	Brief description	Type	Part no.
Mounting brackets and plates			
	Mounting bracket for wall mounting, Stainless steel 1.4571, mounting hardware included	BEF-W4-A	2051628

	Brief description	Type	Part no.
Others			
	<ul style="list-style-type: none"> • Connection type head A: Male connector, M8, 4-pin, straight, A-coded • Description: Unshielded • Connection systems: Screw-type terminals • Permitted cross-section: 0.14 mm² ... 0.5 mm² 	STE-0804-G	6037323

SICK AT A GLANCE

SICK is one of the leading manufacturers of intelligent sensors and sensor solutions for industrial applications. A unique range of products and services creates the perfect basis for controlling processes securely and efficiently, protecting individuals from accidents and preventing damage to the environment.

We have extensive experience in a wide range of industries and understand their processes and requirements. With intelligent sensors, we can deliver exactly what our customers need. In application centers in Europe, Asia and North America, system solutions are tested and optimized in accordance with customer specifications. All this makes us a reliable supplier and development partner.

Comprehensive services complete our offering: SICK LifeTime Services provide support throughout the machine life cycle and ensure safety and productivity.

For us, that is “Sensor Intelligence.”

WORLDWIDE PRESENCE:

Contacts and other locations –www.sick.com