



WTB4SLC-3P2262A00

W4

MINIATURE PHOTOELECTRIC SENSORS

**SICK**  
Sensor Intelligence.



Illustration may differ

### Ordering information

Type	Part no.
WTB4SLC-3P2262A00	1080939

Other models and accessories → [www.sick.com/W4](http://www.sick.com/W4)



### Detailed technical data

#### Features

<b>Functional principle</b>	Photoelectric proximity sensor
<b>Functional principle detail</b>	Background suppression
<b>Sensing range max.</b>	25 mm ... 300 mm <sup>1)</sup>
<b>Sensing range</b>	25 mm ... 300 mm <sup>1)</sup>
<b>Emitted beam</b>	
Light source	Laser <sup>2)</sup>
Type of light	Visible red light
Light spot size (distance)	Ø 1 mm (170 mm)
<b>Key laser figures</b>	
Normative reference	EN 60825-1:2014, IEC 60825-1:2014 / CDRH 21 CFR 1040.10 & 1040.11
Laser class	1
Wave length	650 nm
<b>Adjustment</b>	Cable, Single teach-in button
<b>Special applications</b>	Detecting small objects
<b>Mounting hole</b>	M3

<sup>1)</sup> Object with 90% remission (based on standard white, DIN 5033).

<sup>2)</sup> Average service life: 50,000 h at T<sub>U</sub> = +25 °C.

<b>Pin 2 configuration</b>	External input, Teach-in input, Sender off input, Detection output, logic output
----------------------------	--

<sup>1)</sup> Object with 90% remission (based on standard white, DIN 5033).

<sup>2)</sup> Average service life: 50,000 h at  $T_U = +25 \text{ }^\circ\text{C}$ .

### Safety-related parameters

<b>MTTF<sub>D</sub></b>	326 years (EN ISO 13849-1) <sup>1)</sup>
<b>DC<sub>avg</sub></b>	0 %
<b>T<sub>M</sub> (mission time)</b>	10 years

<sup>1)</sup> Mode of calculation: Parts-Count-calculation.

### Communication interface

<b>IO-Link</b>	✓, COM2 (38,4 kBaud)
Data transmission rate	COM2 (38,4 kBaud)
Cycle time	2.3 ms
Process data length	16 Bit
Process data structure	Bit 0 = switching signal Q <sub>L1</sub> Bit 1 = switching signal Q <sub>L2</sub> Bit 2 ... 15 = empty
VendorID	26
DeviceID HEX	0x800109
DeviceID DEC	8388873

### Electrical data

<b>Supply voltage U<sub>B</sub></b>	10 V DC ... 30 V DC <sup>1)</sup>
<b>Ripple</b>	< 5 V <sub>pp</sub> <sup>2)</sup>
<b>Current consumption</b>	30 mA <sup>3)</sup>
<b>Protection class</b>	III
<b>Digital output</b>	
Type	PNP <sup>4) 5)</sup>
Switching mode	Light/dark switching <sup>4)</sup>
Output current I <sub>max.</sub>	≤ 100 mA
Response time	≤ 0,5 ms <sup>6)</sup>
Repeatability (response time)	150 μs <sup>7)</sup>
Switching frequency	1,000 Hz <sup>8)</sup>

<sup>1)</sup> Limit values when operated in short-circuit protected network: max. 8 A.

<sup>2)</sup> May not fall below or exceed U<sub>y</sub> tolerances.

<sup>3)</sup> Without load.

<sup>4)</sup> Q = light switching.

<sup>5)</sup> Pin 4: This switching output must not be connected to another output.

<sup>6)</sup> Signal transit time with resistive load.

<sup>7)</sup> Valid for Q \ on Pin2, if configured with software.

<sup>8)</sup> With light/dark ratio 1:1.

<sup>9)</sup> A = V<sub>S</sub> connections reverse-polarity protected.

<sup>10)</sup> B = inputs and output reverse-polarity protected.

<sup>11)</sup> C = interference suppression.

<sup>12)</sup> With light / dark ratio 1:1, valid for Q \ on Pin2, if configured with software.

<b>Output function</b>	Complementary
<b>Circuit protection</b>	A <sup>9)</sup> B <sup>10)</sup> C <sup>11)</sup>
<b>Response time Q/ on Pin 2</b>	300 μs ... 450 μs <sup>6) 7)</sup>
<b>Switching frequency Q / to pin 2</b>	1,000 Hz <sup>12)</sup>

- <sup>1)</sup> Limit values when operated in short-circuit protected network: max. 8 A.
- <sup>2)</sup> May not fall below or exceed U<sub>y</sub> tolerances.
- <sup>3)</sup> Without load.
- <sup>4)</sup> Q = light switching.
- <sup>5)</sup> Pin 4: This switching output must not be connected to another output.
- <sup>6)</sup> Signal transit time with resistive load.
- <sup>7)</sup> Valid for Q \ on Pin2, if configured with software.
- <sup>8)</sup> With light/dark ratio 1:1.
- <sup>9)</sup> A = V<sub>S</sub> connections reverse-polarity protected.
- <sup>10)</sup> B = inputs and output reverse-polarity protected.
- <sup>11)</sup> C = interference suppression.
- <sup>12)</sup> With light / dark ratio 1:1, valid for Q \ on Pin2, if configured with software.

### Mechanical data

<b>Housing</b>	Rectangular
<b>Design detail</b>	Slim
<b>Dimensions (W x H x D)</b>	12.2 mm x 41.8 mm x 17.3 mm
<b>Connection</b>	Male connector M8, 4-pin
<b>Material</b>	
Housing	Plastic, Novodur
Front screen	Plastic, PMMA
<b>Weight</b>	100 g

### Ambient data

<b>Enclosure rating</b>	IP66 IP67
<b>Ambient operating temperature</b>	-10 °C ... +50 °C
<b>Ambient operating temperature extended</b>	-30 °C ... +55 °C <sup>1) 2)</sup>
<b>Ambient temperature, storage</b>	-30 °C ... +70 °C
<b>RoHS certificate</b>	✓

- <sup>1)</sup> As of T<sub>a</sub> = 50 °C, a max. supply voltage V<sub>max.</sub> = 24 V and a max. load current I<sub>max.</sub> = 50 mA is permitted.
- <sup>2)</sup> Operation below Tu -10 °C is possible if the sensor is already switched on at Tu > -10 °C, then cools down, and the supply voltage is subsequently not switched off. Switching on below Tu -10 °C is not permissible.

### Smart Task

<b>Smart Task name</b>	Base logics
<b>Logic function</b>	Direct AND OR WINDOW

- <sup>1)</sup> SIO Direct: sensor operation in standard I/O mode without IO-Link communication and without using internal sensor logic or time parameters (set to "direct"/"deactivated").
- <sup>2)</sup> SIO Logic: Sensor operation in standard I/O mode without IO-Link communication. Sensor-internal logic or timing parameters plus Automation Functions used.
- <sup>3)</sup> IOL: Sensor operation with full IO-Link communication and usage of logic, timing and Automation Function parameters.

	Hysteresis
<b>Timer function</b>	Deactivated Switch-on delay Off delay ON and OFF delay Impulse (one shot)
<b>Inverter</b>	Yes
<b>Switching frequency</b>	SIO Direct: 1000 Hz <sup>1)</sup> SIO Logic: 600 Hz <sup>2)</sup> IOL: 450 Hz <sup>3)</sup>
<b>Response time</b>	SIO Direct: 300 µs ... 450 µs <sup>1)</sup> SIO Logic: 750 µs ... 900 µs <sup>2)</sup> IOL: 800 µs ... 1000 µs <sup>3)</sup>
<b>Repeatability</b>	SIO Direct: 150 µs <sup>1)</sup> SIO Logic: 150 µs <sup>2)</sup> IOL: 400 µs <sup>3)</sup>
<b>Switching signal</b>	
	Switching signal Q <sub>L1</sub> Switching output
	Switching signal Q <sub>L2</sub> Switching output

<sup>1)</sup> SIO Direct: sensor operation in standard I/O mode without IO-Link communication and without using internal sensor logic or time parameters (set to "direct"/"deactivated").

<sup>2)</sup> SIO Logic: Sensor operation in standard I/O mode without IO-Link communication. Sensor-internal logic or timing parameters plus Automation Functions used.

<sup>3)</sup> IOL: Sensor operation with full IO-Link communication and usage of logic, timing and Automation Function parameters.

## Diagnosis

<b>Device status</b>	Yes
----------------------	-----

## Classifications

<b>ECLASS 5.0</b>	27270904
<b>ECLASS 5.1.4</b>	27270904
<b>ECLASS 6.0</b>	27270904
<b>ECLASS 6.2</b>	27270904
<b>ECLASS 7.0</b>	27270904
<b>ECLASS 8.0</b>	27270904
<b>ECLASS 8.1</b>	27270904
<b>ECLASS 9.0</b>	27270904
<b>ECLASS 10.0</b>	27270904
<b>ECLASS 11.0</b>	27270904
<b>ECLASS 12.0</b>	27270903
<b>ETIM 5.0</b>	EC002719
<b>ETIM 6.0</b>	EC002719
<b>ETIM 7.0</b>	EC002719
<b>ETIM 8.0</b>	EC002719
<b>UNSPSC 16.0901</b>	39121528

Connection diagram

Cd-367

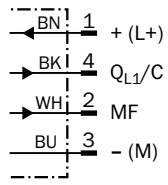

Characteristic curve

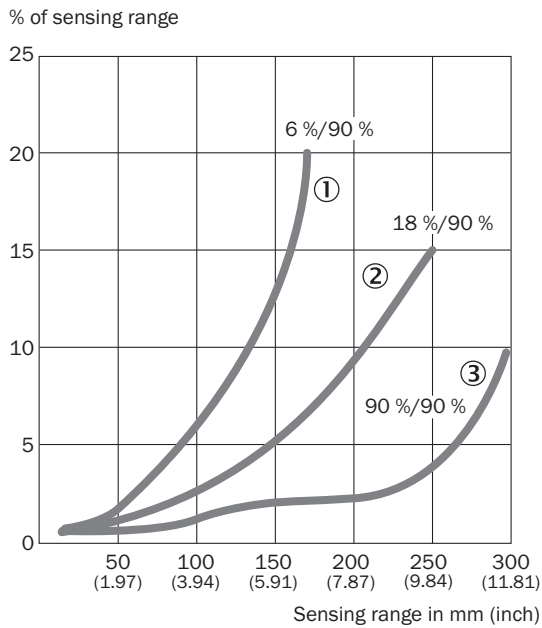

- ① Sensing range on black, 6% remission factor
- ② Sensing range on gray, 18% remission factor
- ③ Sensing range on white, 90% remission factor

### Light spot size

Radius in mm (inch)

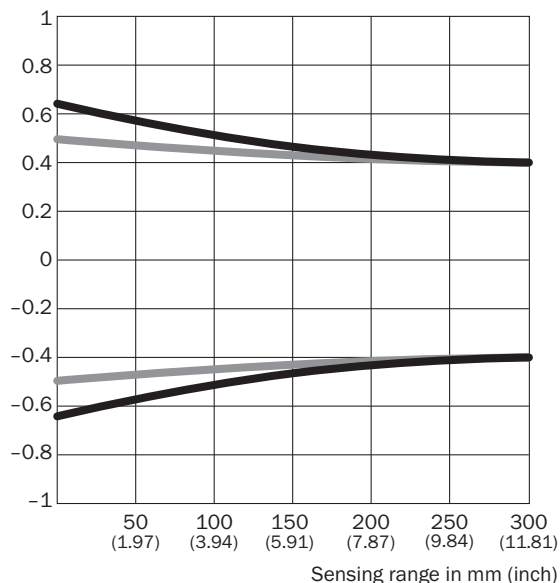

### Dimensions in mm (inch)

Sensing range	Vertical	Horizontal
<b>50 mm</b> <b>(1.97)</b>	1.2 (0.05)	1.0 (0.04)
<b>100 mm</b> <b>(3.94)</b>	1.1 (0.04)	1.0 (0.04)
<b>200 mm</b> <b>(7.87)</b>	0.9 (0.04)	0.9 (0.04)
<b>300 mm</b> <b>(11.81)</b>	0.8 (0.03)	0.8 (0.03)

— Vertical  
 — Horizontal

### Sensing range diagram

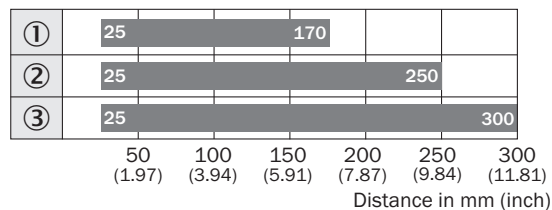

■ Sensing range typ. max.

- ① Sensing range on black, 6% remission factor
- ② Sensing range on gray, 18% remission factor
- ③ Sensing range on white, 90% remission factor

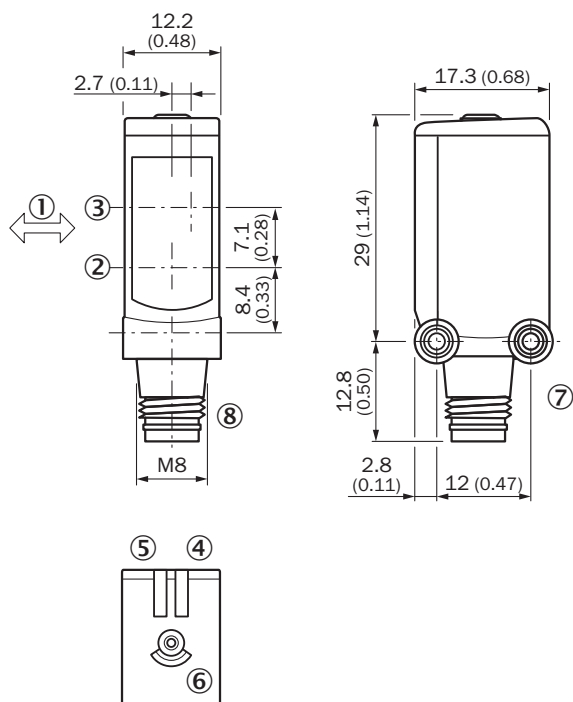

Dimensional drawing (Dimensions in mm (inch))



- ① Standard direction of the material being detected
- ② Center of optical axis, sender
- ③ Center of optical axis, receiver
- ④ LED indicator green: Supply voltage active
- ⑤ LED indicator yellow: Status of received light beam
- ⑥ Single teach-in button
- ⑦ Threaded mounting hole M3
- ⑧ Connection

Recommended accessories

Other models and accessories → [www.sick.com/W4](http://www.sick.com/W4)

	Brief description	Type	Part no.
Others			
	<ul style="list-style-type: none"> <li>• <b>Connection type head A:</b> Female connector, M8, 4-pin, straight, A-coded</li> <li>• <b>Connection type head B:</b> Flying leads</li> <li>• <b>Signal type:</b> Sensor/actuator cable</li> <li>• <b>Cable:</b> 5 m, 4-wire, PVC</li> <li>• <b>Description:</b> Sensor/actuator cable, unshielded</li> <li>• <b>Application:</b> Zones with chemicals</li> </ul>	YF8U14-050VA3XLEAX	2095889
	<ul style="list-style-type: none"> <li>• <b>Connection type head A:</b> Male connector, M8, 4-pin, straight, A-coded</li> <li>• <b>Description:</b> Unshielded</li> <li>• <b>Connection systems:</b> Screw-type terminals</li> <li>• <b>Permitted cross-section:</b> 0.14 mm<sup>2</sup> ... 0.5 mm<sup>2</sup></li> </ul>	STE-0804-G	6037323



Recommended services

Additional services → [www.sick.com/W4](http://www.sick.com/W4)

	Type	Part no.
Function Block Factory		
<ul style="list-style-type: none"><li>• <b>Description:</b> The Function Block Factory supports common programmable logic controllers (PLCs) from various manufacturers, such as Siemens, Beckhoff, Rockwell Automation and B&amp;R. More information on the FBF can be found <a _blank"="" href="https://fbf.cloud.sick.com target=">here</a>.</li><li>• <b>Note:</b> You can configure your function block at <a _blank"="" href="https://fbf.cloud.sick.com target=">Function Block Factory</a>. As a login please use your SICK ID.</li></ul>	Function Block Factory	On request

## SICK AT A GLANCE

SICK is one of the leading manufacturers of intelligent sensors and sensor solutions for industrial applications. A unique range of products and services creates the perfect basis for controlling processes securely and efficiently, protecting individuals from accidents and preventing damage to the environment.

We have extensive experience in a wide range of industries and understand their processes and requirements. With intelligent sensors, we can deliver exactly what our customers need. In application centers in Europe, Asia and North America, system solutions are tested and optimized in accordance with customer specifications. All this makes us a reliable supplier and development partner.

Comprehensive services complete our offering: SICK LifeTime Services provide support throughout the machine life cycle and ensure safety and productivity.

For us, that is “Sensor Intelligence.”

## WORLDWIDE PRESENCE:

Contacts and other locations –[www.sick.com](http://www.sick.com)