



WTB9C-3P3462A00

W9

SMALL PHOTOELECTRIC SENSORS

SICK
Sensor Intelligence.



Illustration may differ



Ordering information

Type	Part no.
WTB9C-3P3462A00	1098209

Other models and accessories → www.sick.com/W9

Detailed technical data

Features

Functional principle	Photoelectric proximity sensor
Functional principle detail	Background suppression
Dimensions (W x H x D)	12.2 mm x 52.2 mm x 23.6 mm
Housing design (light emission)	Rectangular
Mounting hole	M3
Sensing range max.	20 mm ... 350 mm ¹⁾
Sensing range	20 mm ... 200 mm ²⁾
Type of light	Visible red light
Light source	PinPoint LED ³⁾
Light spot size (distance)	Ø 4.5 mm (75 mm)
Wave length	650 nm
Adjustment	IO-Link, Single teach-in button
Pin 2 configuration	External input, Teach-in input, Sender off input, Detection output, logic output

¹⁾ Object with 90% remission (based on standard white, DIN 5033).

²⁾ Object with 6% remission (based on standard white, DIN 5033).

³⁾ Average service life: 100,000 h at T_U = +25 °C.

Mechanics/electronics

Supply voltage U_B	10 V DC ... 30 V DC ¹⁾
Ripple	< 5 V _{pp} ²⁾
Current consumption	30 mA ³⁾
Switching output	PNP ^{4) 5)}
Output function	Complementary
Switching mode	Light/dark switching ⁴⁾
Output current I_{max}	≤ 100 mA ⁶⁾
Response time	< 0.333 ms ⁷⁾
Response time Q/ on Pin 2	200 μs ... 300 μs ^{7) 8)}
Switching frequency	1,500 Hz ⁹⁾
Switching frequency Q / to pin 2	≤ 1,500 Hz ¹⁰⁾
Connection type	Cable with M12 male connector, 4-pin, 120 mm
Circuit protection	A ¹¹⁾ B ¹²⁾ C ¹³⁾
Protection class	III
Weight	13 g
Housing material	Plastic, VISTAL®
Optics material	Plastic, PMMA
Enclosure rating	IP66 IP67 IP69K
Ambient operating temperature	-40 °C ... +60 °C
Ambient temperature, storage	-40 °C ... +75 °C
UL File No.	NRKH.E181493
Repeatability Q/ on Pin 2:	100 μs ⁸⁾

1) Limit values when operated in short-circuit protected network: max. 8 A.

2) May not fall below or exceed U_y tolerances.

3) Without load.

4) Q = light switching.

5) Pin 4: This switching output must not be connected to another output.

6) At and above T_u 50 °C, a max. load current of $I_{max} = 50$ mA is permitted.

7) Signal transit time with resistive load.

8) Valid for Q \ on Pin2, if configured with software.

9) With light/dark ratio 1:1.

10) With light / dark ratio 1:1, valid for Q \ on Pin2, if configured with software.

11) A = V_S connections reverse-polarity protected.

12) B = inputs and output reverse-polarity protected.

13) C = interference suppression.

Safety-related parameters

MTTF_D	865 years
DC_{avg}	0 %
T_M (mission time)	20 years

Communication interface

Communication interface	IO-Link V1.1
Communication Interface detail	COM2 (38,4 kBaud)
Cycle time	2.3 ms
Process data length	16 Bit
Process data structure	Bit 0 = switching signal Q _{L1} Bit 1 = switching signal Q _{L2} Bit 2 ... 15 = empty
VendorID	26
DeviceID HEX	0x8000FA
DeviceID DEC	8388858

Smart Task

Smart Task name	Base logics
Logic function	Direct AND OR WINDOW Hysteresis
Timer function	Deactivated Switch-on delay Off delay ON and OFF delay Impulse (one shot)
Inverter	Yes
Switching frequency	SIO Direct: 1500 Hz ¹⁾ SIO Logic: 600 Hz ²⁾ IOL: 450 Hz ³⁾
Response time	SIO Direct: 200 µs ... 300 µs ¹⁾ SIO Logic: 650 µs ... 750 µs ²⁾ IOL: 650 µs ... 1000 µs ³⁾
Repeatability	SIO Direct: 100 µs ¹⁾ SIO Logic: 100 µs ²⁾ IOL: 350 µs ³⁾
Switching signal	
	Switching signal Q _{L1} Output type (dependant on the adjusted threshold)
	Switching signal Q _{L2} Output type (dependant on the adjusted threshold)

¹⁾ SIO Direct: sensor operation in standard I/O mode without IO-Link communication and without using internal sensor logic or time parameters (set to "direct"/"deactivated").

²⁾ SIO Logic: Sensor operation in standard I/O mode without IO-Link communication. Sensor-internal logic or timing parameters plus Automation Functions used.

³⁾ IOL: Sensor operation with full IO-Link communication and usage of logic, timing and Automation Function parameters.

Diagnosis

Device status	Yes
----------------------	-----

Classifications

ECLASS 5.0	27270904
ECLASS 5.1.4	27270904
ECLASS 6.0	27270904
ECLASS 6.2	27270904

ECLASS 7.0	27270904
ECLASS 8.0	27270904
ECLASS 8.1	27270904
ECLASS 9.0	27270904
ECLASS 10.0	27270904
ECLASS 11.0	27270904
ECLASS 12.0	27270903
ETIM 5.0	EC002719
ETIM 6.0	EC002719
ETIM 7.0	EC002719
ETIM 8.0	EC002719
UNSPSC 16.0901	39121528

Adjustments

Single teach-in button

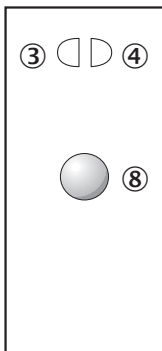

- ③ LED indicator yellow: Status of received light beam
- ④ LED indicator green: power on
- ⑧ Teach-in button

Potentiometer



- ④ LED indicator yellow: Status of received light beam
- ⑤ LED indicator green: power on
- ⑨ Adjustment of sensing range

Connection type

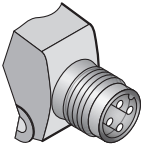

Connection diagram

Cd-367

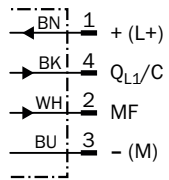

Characteristic curve

WT9-3, red light, 350 mm

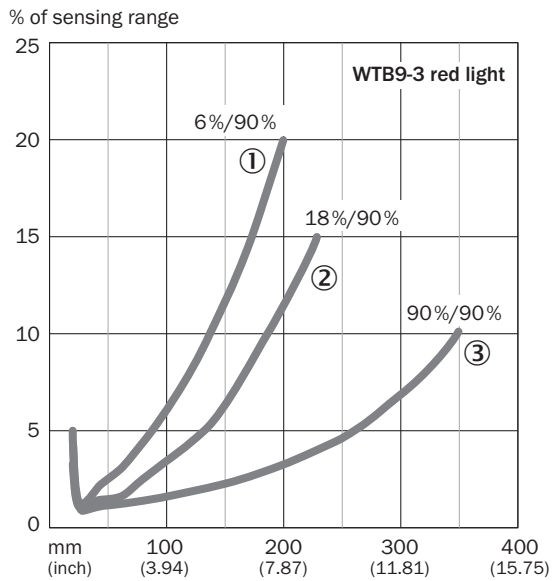

- ① Sensing range on black, 6% remission factor
- ② Sensing range on gray, 18% remission factor
- ③ Sensing range on white, 90% remission factor

Light spot size

WT9-3, red light, 350 mm

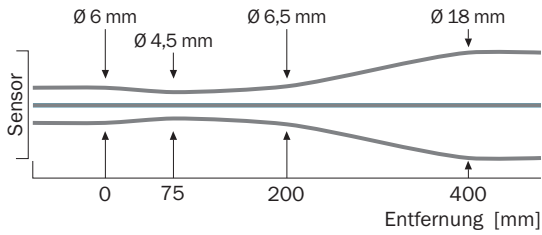

Sensing range diagram

WT9-3, red light, 350 mm

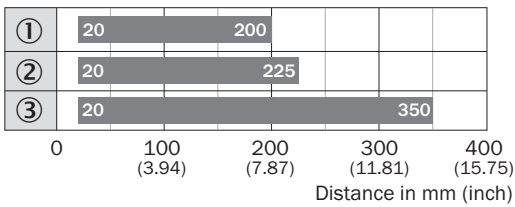

■ Sensing range

- ① Sensing range on black, 6% remission factor
- ② Sensing range on gray, 18% remission factor
- ③ Sensing range on white, 90% remission factor

Dimensional drawing (Dimensions in mm (inch))

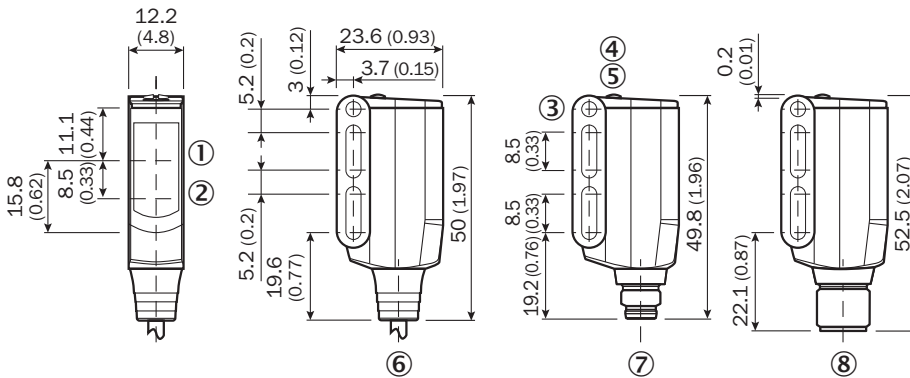

WT9-3



- ① Center of optical axis, receiver
- ② Center of optical axis, sender
- ③ Mounting hole M3 (Ø 3.1 mm)
- ④ LED indicator yellow: Status of received light beam
- ⑤ LED indicator green: power on
- ⑥ Connection cable 2 m
- ⑦ Male connector M8, 4-pin
- ⑧ Male connector M12, 4-pin

Recommended accessories

Other models and accessories → www.sick.com/W9

	Brief description	Type	Part no.
Mounting brackets and plates			
	Mounting bracket, steel, zinc coated, mounting hardware included	BEF-WN-W9-2	2022855
Others			
	<ul style="list-style-type: none"> • Connection type head A: Female connector, M12, 4-pin, straight, A-coded • Connection type head B: Flying leads • Signal type: Sensor/actuator cable • Cable: 5 m, 4-wire, PVC • Description: Sensor/actuator cable, unshielded • Application: Zones with chemicals, Uncontaminated zones 	YF2A14-050VB3XLEAX	2096235
	<ul style="list-style-type: none"> • Connection type head A: Male connector, M12, 4-pin, straight, A-coded • Description: Unshielded • Connection systems: Screw-type terminals • Permitted cross-section: ≤ 0.75 mm² 	STE-1204-G	6009932

Recommended services

Additional services → www.sick.com/W9

	Type	Part no.
Function Block Factory		
<ul style="list-style-type: none"> • Description: The Function Block Factory is an engineering tool for creating device and environment-specific function blocks that enable IO-Link sensors to be integrated into programmable logic controllers. The Function Block Factory supports common programmable logic controllers (PLCs) of various manufacturers such as Siemens, Beckhoff, Rockwell Automation B&R and more. More information on the FBF can be found here. • Provision: Customers can obtain access to the Function Block Factory and the license via https://fbf.cloud.sick.com. 	Function Block Factory	On request

SICK AT A GLANCE

SICK is one of the leading manufacturers of intelligent sensors and sensor solutions for industrial applications. A unique range of products and services creates the perfect basis for controlling processes securely and efficiently, protecting individuals from accidents and preventing damage to the environment.

We have extensive experience in a wide range of industries and understand their processes and requirements. With intelligent sensors, we can deliver exactly what our customers need. In application centers in Europe, Asia and North America, system solutions are tested and optimized in accordance with customer specifications. All this makes us a reliable supplier and development partner.

Comprehensive services complete our offering: SICK LifeTime Services provide support throughout the machine life cycle and ensure safety and productivity.

For us, that is “Sensor Intelligence.”

WORLDWIDE PRESENCE:

Contacts and other locations –www.sick.com