



WTB9LC-3P3492A00

W9

SMALL PHOTOELECTRIC SENSORS

SICK
Sensor Intelligence.



Illustration may differ

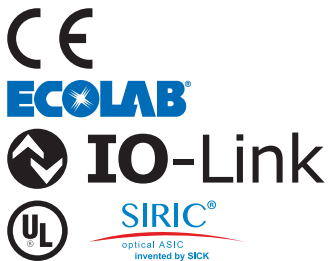

Ordering information

Type	Part no.
WTB9LC-3P3492A00	1125677

Other models and accessories → www.sick.com/W9

Detailed technical data

Features

Functional principle	Photoelectric proximity sensor
Functional principle detail	Background suppression
Dimensions (W x H x D)	12.2 mm x 52.2 mm x 23.6 mm
Housing design (light emission)	Rectangular
Mounting hole	M3
Sensing range max.	25 mm ... 400 mm ¹⁾
Sensing range	25 mm ... 400 mm ¹⁾
Type of light	Visible red light
Light source	Laser ²⁾
Light spot size (distance)	Ø 0.9 mm (230 mm)
Wave length	650 nm
Laser class	2 (IEC 60825-1 / CDRH 21 CFR 1040.10 & 1040.11)
Adjustment	IO-Link, Single teach-in button
Pin 2 configuration	External input, Teach-in input, Sender off input, Detection output, logic output
Special applications	Detecting small objects

¹⁾ Object with 90% remission (based on standard white, DIN 5033).

²⁾ Average service life: 50,000 h at T_J = +25 °C.

Mechanics/electronics

Supply voltage U_B	10 V DC ... 30 V DC ¹⁾
Ripple	< 5 V _{pp} ²⁾
Current consumption	30 mA ³⁾
Switching output	PNP ^{4) 5)}
Output function	Complementary
Switching mode	Light/dark switching ⁴⁾
Output current $I_{max.}$	≤ 100 mA
Response time	≤ 1 ms ⁶⁾
Response time Q/ on Pin 2	700 μs ... 850 μs ^{6) 7)}
Switching frequency	500 Hz ⁸⁾
Switching frequency Q / to pin 2	≤ 500 Hz ⁹⁾
Connection type	Cable with M12 male connector, 4-pin, 120 mm ¹⁰⁾
Cable material	Plastic, PVC
Circuit protection	A ¹¹⁾ B ¹²⁾ C ¹³⁾
Protection class	III
Weight	80 g
Housing material	Plastic, VISTAL®
Optics material	Plastic, PMMA
Enclosure rating	IP66 IP67 IP69K
Ambient operating temperature	-10 °C ... +50 °C
Ambient operating temperature extended	-30 °C ... +55 °C ^{14) 15)}
Ambient temperature, storage	-30 °C ... +70 °C
UL File No.	NRKH.E181493
Repeatability Q/ on Pin 2:	150 μs ⁷⁾

¹⁾ Limit values when operated in short-circuit protected network: max. 8 A.

²⁾ May not fall below or exceed U_y tolerances.

³⁾ Without load.

⁴⁾ Q = light switching.

⁵⁾ Pin 4: This switching output must not be connected to another output.

⁶⁾ Signal transit time with resistive load.

⁷⁾ Valid for Q \ on Pin2, if configured with software.

⁸⁾ With light/dark ratio 1:1.

⁹⁾ With light / dark ratio 1:1, valid for Q \ on Pin2, if configured with software.

¹⁰⁾ Do not bend below 0 °C.

¹¹⁾ A = V_S connections reverse-polarity protected.

¹²⁾ B = inputs and output reverse-polarity protected.

¹³⁾ C = interference suppression.

¹⁴⁾ As of $T_a = 50$ °C, a max. supply voltage $V_{max.} = 24$ V and a max. load current $I_{max.} = 50$ mA is permitted.

¹⁵⁾ Operation below $T_u -10$ °C is possible if the sensor is already switched on at $T_u > -10$ °C, then cools down, and the supply voltage is subsequently not switched off. Switching on below $T_u -10$ °C is not permissible.

Safety-related parameters

MTTF_D	326 years (EN ISO 13849-1) ¹⁾
DC_{avg}	0 %
T_M (mission time)	10 years

¹⁾ Mode of calculation: Parts-Count-calculation.

Communication interface

Communication interface	IO-Link V1.1
Communication Interface detail	COM2 (38,4 kBaud)
Cycle time	2.3 ms
Process data length	16 Bit
Process data structure	Bit 0 = switching signal Q _{L1} Bit 1 = switching signal Q _{L2} Bit 2 ... 15 = empty
VendorID	26
DeviceID HEX	0x80010C
DeviceID DEC	8388876

Smart Task

Smart Task name	Base logics
Logic function	Direct AND OR WINDOW Hysteresis
Timer function	Deactivated Switch-on delay Off delay ON and OFF delay Impulse (one shot)
Inverter	Yes
Switching frequency	SIO Direct: 500 Hz ¹⁾ SIO Logic: 350 Hz ²⁾ IOL: 300 Hz ³⁾
Response time	SIO Direct: 700 μs ... 850 μs ¹⁾ SIO Logic: 1150 μs ... 1300 μs ²⁾ IOL: 1200 μs ... 1600 μs ³⁾
Repeatability	SIO Direct: 150 μs ¹⁾ SIO Logic: 150 μs ²⁾ IOL: 400 μs ³⁾
Switching signal	
	Switching signal Q _{L1} Output type (dependant on the adjusted threshold)
	Switching signal Q _{L2} Output type (dependant on the adjusted threshold)

¹⁾ SIO Direct: sensor operation in standard I/O mode without IO-Link communication and without using internal sensor logic or time parameters (set to "direct"/"deactivated").

²⁾ SIO Logic: Sensor operation in standard I/O mode without IO-Link communication. Sensor-internal logic or timing parameters plus Automation Functions used.

³⁾ IOL: Sensor operation with full IO-Link communication and usage of logic, timing and Automation Function parameters.

Diagnosis

Device status	Yes
----------------------	-----

Classifications

ECLASS 5.0	27270904
ECLASS 5.1.4	27270904
ECLASS 6.0	27270904
ECLASS 6.2	27270904
ECLASS 7.0	27270904
ECLASS 8.0	27270904
ECLASS 8.1	27270904
ECLASS 9.0	27270904
ECLASS 10.0	27270904
ECLASS 11.0	27270904
ECLASS 12.0	27270903
ETIM 5.0	EC002719
ETIM 6.0	EC002719
ETIM 7.0	EC002719
ETIM 8.0	EC002719
UNSPSC 16.0901	39121528

Adjustments

Single teach-in button

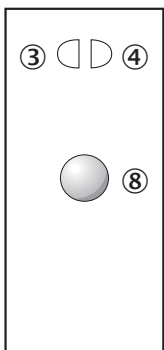

- ③ LED indicator yellow: Status of received light beam
- ④ LED indicator green: power on
- ⑧ Teach-in button

Connection diagram

Cd-367

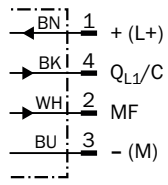

Characteristic curve

WTB9L-3, laser class 2

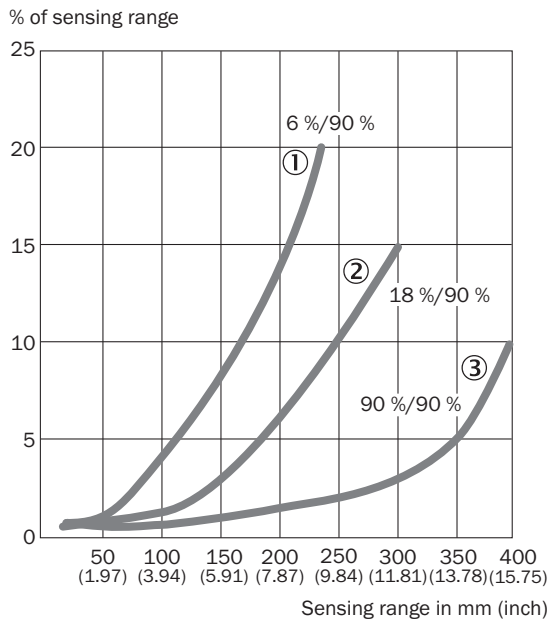

- ① Sensing range on black, 6% remission factor
- ② Sensing range on gray, 18% remission factor
- ③ Sensing range on white, 90% remission factor

Light spot size

WTB9L-3, laser class 2

Radius in mm (inch)

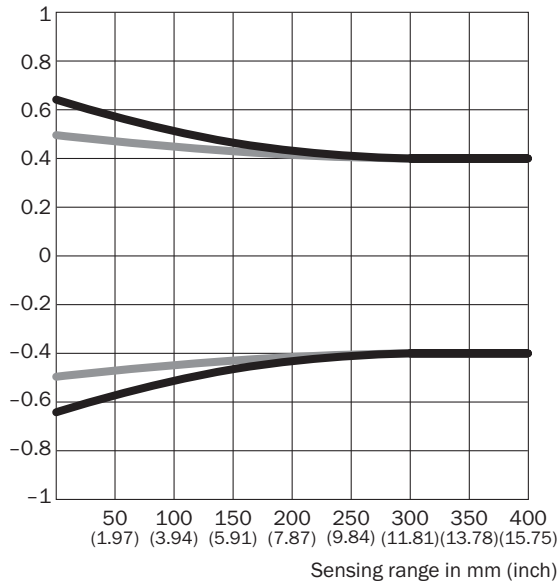

Dimensions in mm (inch)

Sensing range	Vertical	Horizontal
50 mm (1.97)	1.2 (0.05)	1.0 (0.04)
100 mm (3.94)	1.1 (0.04)	1.0 (0.04)
200 mm (7.87)	0.9 (0.04)	0.9 (0.04)
400 mm (15.75)	0.8 (0.03)	0.8 (0.03)

— Vertical
— Horizontal

Sensing range diagram

WTB9L-3, laser class 2

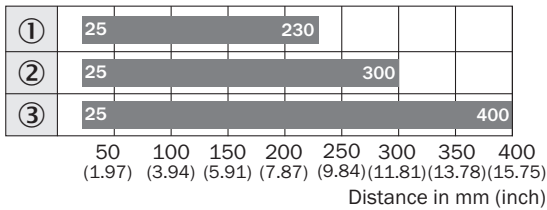

■ Sensing range typ. max.

- ① Sensing range on black, 6% remission factor
- ② Sensing range on gray, 18% remission factor
- ③ Sensing range on white, 90% remission factor

Dimensional drawing (Dimensions in mm (inch))

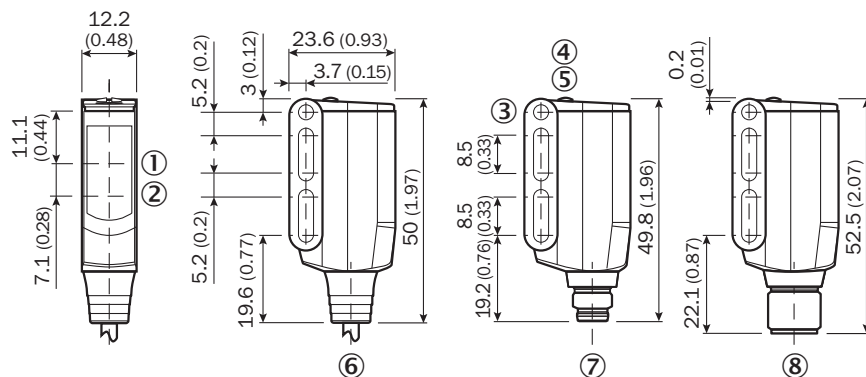

WTB9L-3



- ① Center of optical axis, receiver
- ② Center of optical axis, sender
- ③ Mounting hole M3 (Ø 3.1 mm)
- ④ LED indicator yellow: Status of received light beam
- ⑤ LED indicator green: power on
- ⑥ Connecting cable or connecting cable with connector
- ⑦ Male connector M8, 4-pin
- ⑧ Male connector M12, 4-pin

Recommended accessories

Other models and accessories → www.sick.com/W9

	Brief description	Type	Part no.
Mounting brackets and plates			
	Mounting bracket, steel, zinc coated, mounting hardware included	BEF-WN-W9-2	2022855
Others			
	<ul style="list-style-type: none"> • Connection type head A: Male connector, M12, 4-pin, straight, A-coded • Description: Unshielded • Connection systems: Screw-type terminals • Permitted cross-section: ≤ 0.75 mm² 	STE-1204-G	6009932
	<ul style="list-style-type: none"> • Connection type head A: Female connector, M12, 4-pin, straight, A-coded • Connection type head B: Flying leads • Signal type: Sensor/actuator cable • Cable: 5 m, 4-wire, PVC • Description: Sensor/actuator cable, unshielded • Application: Zones with chemicals, Uncontaminated zones 	YF2A14-050VB3XLEAX	2096235

SICK AT A GLANCE

SICK is one of the leading manufacturers of intelligent sensors and sensor solutions for industrial applications. A unique range of products and services creates the perfect basis for controlling processes securely and efficiently, protecting individuals from accidents and preventing damage to the environment.

We have extensive experience in a wide range of industries and understand their processes and requirements. With intelligent sensors, we can deliver exactly what our customers need. In application centers in Europe, Asia and North America, system solutions are tested and optimized in accordance with customer specifications. All this makes us a reliable supplier and development partner.

Comprehensive services complete our offering: SICK LifeTime Services provide support throughout the machine life cycle and ensure safety and productivity.

For us, that is “Sensor Intelligence.”

WORLDWIDE PRESENCE:

Contacts and other locations –www.sick.com