



WTB9M4L-3P3461

W9

SMALL PHOTOELECTRIC SENSORS

SICK
Sensor Intelligence.



Illustration may differ



Ordering information

Type	Part no.
WTB9M4L-3P3461	1063663

Other models and accessories → www.sick.com/W9

Detailed technical data

Features

Functional principle	Photoelectric proximity sensor
Functional principle detail	Background suppression
Dimensions (W x H x D)	12.2 mm x 52.2 mm x 23.6 mm
Housing design (light emission)	Rectangular
Mounting hole	M4
Sensing range max.	25 mm ... 300 mm ¹⁾
Sensing range	25 mm ... 300 mm ¹⁾
Type of light	Visible red light
Light source	Laser ²⁾
Light spot size (distance)	Ø 1 mm (170 mm)
Wave length	650 nm
Laser class	1 (IEC 60825-1 / CDRH 21 CFR 1040.10 & 1040.11)
Adjustment	Potentiometer, 5 turns
Special applications	Detecting small objects

¹⁾ Object with 90% remission (based on standard white, DIN 5033).

²⁾ Average service life: 50,000 h at T_U = +25 °C.

Mechanics/electronics

Supply voltage U_B	10 V DC ... 30 V DC ¹⁾
Ripple	< 5 V _{pp} ²⁾
Current consumption	30 mA ³⁾
Switching output	PNP ⁴⁾
Output function	Complementary
Switching mode	Light/dark switching ⁴⁾
Output current I_{max}	≤ 100 mA
Response time	≤ 0.5 ms ⁵⁾
Switching frequency	1,000 Hz ⁶⁾
Connection type	Cable with M12 male connector, 4-pin, 120 mm ⁷⁾
Cable material	Plastic, PVC
Circuit protection	A ⁸⁾ B ⁹⁾ C ¹⁰⁾
Protection class	III
Weight	13 g
Housing material	Plastic, VISTAL®
Optics material	Plastic, PMMA
Enclosure rating	IP66 IP67 IP69K
Ambient operating temperature	-10 °C ... +50 °C
Ambient operating temperature extended	-30 °C ... +55 °C ^{11) 12)}
Ambient temperature, storage	-30 °C ... +70 °C
UL File No.	NRKH.E181493

¹⁾ Limit values when operated in short-circuit protected network: max. 8 A.

²⁾ May not fall below or exceed U_y tolerances.

³⁾ Without load.

⁴⁾ Q = light switching.

⁵⁾ Signal transit time with resistive load.

⁶⁾ With light/dark ratio 1:1.

⁷⁾ Do not bend below 0 °C.

⁸⁾ A = V_S connections reverse-polarity protected.

⁹⁾ B = inputs and output reverse-polarity protected.

¹⁰⁾ C = interference suppression.

¹¹⁾ As of $T_a = 50$ °C, a max. supply voltage $V_{max} = 24$ V and a max. load current $I_{max} = 50$ mA is permitted.

¹²⁾ Operation below $T_u - 10$ °C is possible if the sensor is already switched on at $T_u > -10$ °C, then cools down, and the supply voltage is subsequently not switched off. Switching on below $T_u - 10$ °C is not permissible.

Safety-related parameters

MTTF_D	424 years (EN ISO 13849-1) ¹⁾
-------------------------	--

¹⁾ Mode of calculation: Parts-Count-calculation.

Classifications

ECLASS 5.0	27270904
-------------------	----------

ECLASS 5.1.4	27270904
ECLASS 6.0	27270904
ECLASS 6.2	27270904
ECLASS 7.0	27270904
ECLASS 8.0	27270904
ECLASS 8.1	27270904
ECLASS 9.0	27270904
ECLASS 10.0	27270904
ECLASS 11.0	27270904
ECLASS 12.0	27270903
ETIM 5.0	EC002719
ETIM 6.0	EC002719
ETIM 7.0	EC002719
ETIM 8.0	EC002719
UNSPSC 16.0901	39121528

Adjustments

Potentiometer

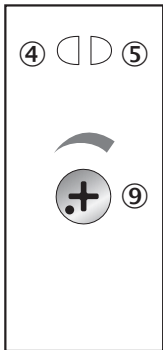

- ④ LED indicator yellow: Status of received light beam
- ⑤ LED indicator green: power on
- ⑨ Adjustment of sensing range

Connection diagram

Cd-083

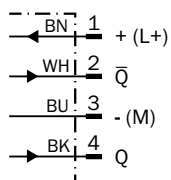

Characteristic curve

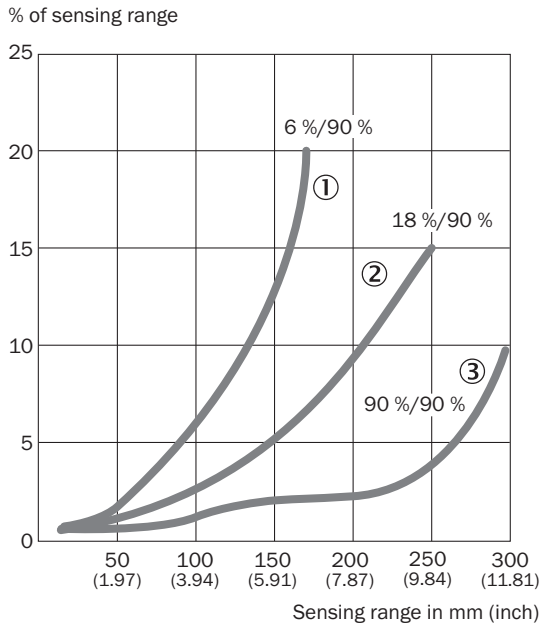

- ① Sensing range on black, 6% remission factor
- ② Sensing range on gray, 18% remission factor
- ③ Sensing range on white, 90% remission factor

Light spot size

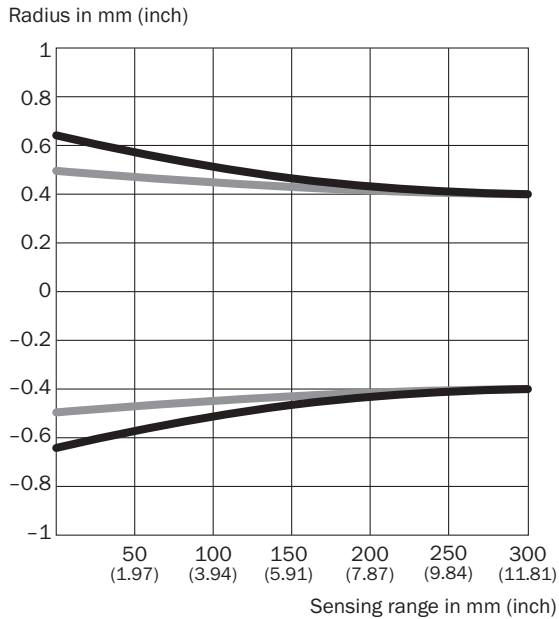

Dimensions in mm (inch)

Sensing range	Vertical	Horizontal
50 mm (1.97)	1.2 (0.05)	1.0 (0.04)
100 mm (3.94)	1.1 (0.04)	1.0 (0.04)
200 mm (7.87)	0.9 (0.04)	0.9 (0.04)
300 mm (11.81)	0.8 (0.03)	0.8 (0.03)

— Vertical
— Horizontal

Sensing range diagram

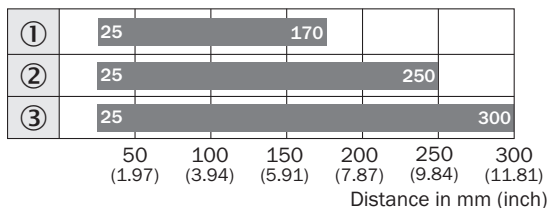

■ Sensing range typ. max.

- ① Sensing range on black, 6% remission factor
- ② Sensing range on gray, 18% remission factor
- ③ Sensing range on white, 90% remission factor

Dimensional drawing (Dimensions in mm (inch))

WTB9M4L-3

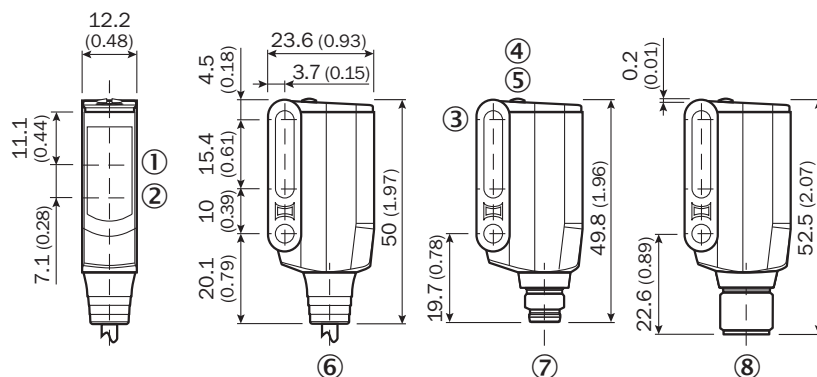



- ① Center of optical axis, receiver
- ② Center of optical axis, sender
- ③ Mounting hole M4 (Ø 4.1 mm)
- ④ LED indicator yellow: Status of received light beam
- ⑤ LED indicator green: power on
- ⑥ Connecting cable or connecting cable with connector
- ⑦ Male connector M8, 4-pin
- ⑧ Male connector M12, 4-pin

Recommended accessories

Other models and accessories → www.sick.com/W9

	Brief description	Type	Part no.
Mounting brackets and plates			
	Mounting bracket, steel, zinc coated, mounting hardware included	BEF-WN-W9-2	2022855

	Brief description	Type	Part no.
Others			
	<ul style="list-style-type: none"> • Connection type head A: Female connector, M12, 4-pin, straight, A-coded • Connection type head B: Flying leads • Signal type: Sensor/actuator cable • Cable: 5 m, 4-wire, PVC • Description: Sensor/actuator cable, unshielded • Application: Zones with chemicals, Uncontaminated zones 	YF2A14-050VB3XLEAX	2096235
	<ul style="list-style-type: none"> • Connection type head A: Male connector, M12, 4-pin, straight, A-coded • Description: Unshielded • Connection systems: Screw-type terminals • Permitted cross-section: ≤ 0.75 mm² 	STE-1204-G	6009932

SICK AT A GLANCE

SICK is one of the leading manufacturers of intelligent sensors and sensor solutions for industrial applications. A unique range of products and services creates the perfect basis for controlling processes securely and efficiently, protecting individuals from accidents and preventing damage to the environment.

We have extensive experience in a wide range of industries and understand their processes and requirements. With intelligent sensors, we can deliver exactly what our customers need. In application centers in Europe, Asia and North America, system solutions are tested and optimized in accordance with customer specifications. All this makes us a reliable supplier and development partner.

Comprehensive services complete our offering: SICK LifeTime Services provide support throughout the machine life cycle and ensure safety and productivity.

For us, that is “Sensor Intelligence.”

WORLDWIDE PRESENCE:

Contacts and other locations –www.sick.com