



WTM12L-24161120A00

W12

SMALL PHOTOELECTRIC SENSORS

SICK
Sensor Intelligence.



Illustration may differ

Ordering information

Type	Part no.
WTM12L-24161120A00	1125113

Other models and accessories → www.sick.com/W12



Detailed technical data

Features

Functional principle	Photoelectric proximity sensor
Functional principle detail	Background suppression, Foreground suppression, MultiMode
MultiMode	<ul style="list-style-type: none"> 1 Background suppression 2 Foreground suppression 3 Two-point teach-in 4 Two independent switching points 5 Window 6 ApplicationSelect M manual / measurement
Sensing range	
Sensing range min.	80 mm (Mode 1, 3, 4, 5) 80 mm (Mode 2) 80 mm (Mode 1 and 6 combined)
Sensing range max.	850 mm (Mode 1, 3, 4, 5) 350 mm (Mode 2) 1,200 mm (Mode 1 and 6 combined)
Adjustable switching threshold for background suppression	90 mm ... 850 mm (Mode 1, 3, 4, 5) 100 mm ... 350 mm (Mode 2) 90 mm ... 1,200 mm (Mode 1 and 6 combined)
Reference object	Object with 90% remission factor (complies with standard white according to DIN 5033)
Minimum distance between set sensing range and background (black 6% / white 90%)	6 mm, at a distance of 250 mm (Mode 1, 3, 4, 5) 6 mm, at a distance of 650 mm (Mode 1 and 6 combined)

¹⁾ 90% remission factor.

²⁾ Equivalent to 1 σ .

³⁾ See repeatability characteristic lines.

Minimum object height at set sensing range in front of black background (6% remission factor)	2.2 mm, at a distance of 150 mm (Mode 2)
Recommended sensing range for the best performance	100 mm ... 300 mm (Mode 1, 3, 4, 5) 100 mm ... 200 mm (Mode 2) 100 mm ... 700 mm (Mode 1 and 6 combined)
Distance value	
Measuring range	100 mm ... 850 mm
Resolution	1 mm
Repeatability	0,1 mm ... 6 mm ^{1) 2) 3)}
Accuracy	Typ. 6.0 mm at 100 ... 200 mm distance, Typ. 12 mm at 200 ... 400 mm distance, Typ. 30 mm at 400 ... 800 mm distance ^{1) 1) 1)}
Distance value output	Via IO-Link
Update rate of the distance value	20 ms
Emitted beam	
Light source	Laser
Type of light	Visible red light
Shape of light spot	Ellipse shape
Light spot size (distance)	2.2 mm x 1.2 mm (300 mm)
Maximum dispersion of the emitted beam around the standardized transmission axis (squint angle)	< +/- 1.0° (at Ta = +23 °C)
Key laser figures	
Normative reference	EN 60825-1:2014, IEC 60825-1:2014
Laser class	1
Wave length	655 nm
Pulse duration	4 µs
Maximum pulse power	< 6.74 mW
Average service life	50,000 h at T _U = +25 °C
Smallest detectable object (MDO) typ.	
	2.5 mm (at a distance of 300 mm, Mode 1, 3, 4, 5) 2.5 mm (at a distance of 200 mm, Mode 2) 1.3 mm (at a distance of 650 mm, Mode 1 and 6 combined) Object with 90% remission factor (complies with standard white according to DIN 5033)
Adjustment	
Teach-Turn adjustment	BluePilot: For adjusting the sensing range with mode selection
IO-Link	For configuring the sensor parameters and Smart Task functions
Indication	
LED blue	BluePilot: Display of mode, display of output states Q _{L1} (LED 3 permanently on) and Q _{L2} (LED 5 permanently on)
LED green	Operating indicator Static on: power on Flashing: IO-Link mode
LED yellow	Status of received light beam Static on: object present Static off: object not present

¹⁾ 90% remission factor.

²⁾ Equivalent to 1 σ.

³⁾ See repeatability characteristic lines.

Special features	MultiMode
Special applications	Detecting small objects, Detection of objects moving at high speeds, Detecting flat objects, Detecting uneven, shiny objects, Detection of poorly remitting and tilted objects, Detecting perforated objects

- 1) 90% remission factor.
 2) Equivalent to 1 σ .
 3) See repeatability characteristic lines.

Safety-related parameters

MTTF_D	280 years
DC_{avg}	0 %
T_M (mission time)	10 years (EN ISO 13849, rate of use: 60 %)

Communication interface

IO-Link	✓, IO-Link V1.1
Data transmission rate	COM2 (38,4 kBaud)
Cycle time	2.3 ms
Process data length	16 Bit
Process data structure	Bit 0 = switching signal Q _{L1} Bit 1 = switching signal Q _{L2} Bit 2 ... 15 = Current receiver level (live)
VendorID	26
DeviceID HEX	0x8002CC
DeviceID DEC	8389324
Compatible master port type	A
SIO mode support	Yes

Electrical data

Supply voltage U_B	10 V DC ... 30 V DC ¹⁾
Ripple	≤ 5 V
Usage category	DC-12 (According to EN 60947-5-2) DC-13 (According to EN 60947-5-2)
Current consumption	≤ 14 mA, without load. At U _B = 24 V
Protection class	III
Digital output	
Number	2 (Complementary)
Type	Push-pull: PNP/NPN
Switching mode	Light/dark switching
Signal voltage PNP HIGH/LOW	Approx. U _B -2.5 V / 0 V
Signal voltage NPN HIGH/LOW	Approx. U _B / < 2.5 V
Output current I _{max.}	≤ 100 mA
Circuit protection outputs	Reverse polarity protected Overcurrent protected Short-circuit protected

- 1) Limit values.
 2) Signal transit time with resistive load in switching mode.
 3) With light/dark ratio 1:1.
 4) This switching output must not be connected to another output.

Response time	≤ 500 μs, ≤ 1,000 μs, ≤ 15 ms (Mode 1, 2, 3, Mode 4, 5, Mode 1 and 6 combined) ^{2) 2) 2)}
Repeatability (response time)	150 μs (Mode 1, 2, 3) ²⁾ 350 μs (Mode 4, 5) ²⁾ 5 ms (Mode 1 and 6 combined) ²⁾
Switching frequency	1,000 Hz, 500 Hz, 30 Hz (Mode 1, 2, 3, Mode 4, 5, Mode 1 and 6 combined) ^{3) 3) 3)}
Pin/Wire assignment	
BN 1	+ (L+)
WH 2	\bar{Q}_{L1} /MF Digital output, dark switching, object present → output \bar{Q}_{L1} LOW (Mode 1, 3, 5, 6). digital output, dark switching, object present → output \bar{Q}_{L1} HIGH (Mode 2). digital output, light switching, object present → output QL2 HIGH (Mode 4). ⁴⁾ The pin 2 function of the sensor can be configuredAdditional possible settings via IO-Link
BU 3	- (M)
BK 4	QL1/C Digital output, light switching, object present → output QL1 HIGH (Mode 1, 3, 4, 5, 6). digital output, light switching, object present → output QL1 LOW (Mode 2)IO-Link communication C ⁴⁾ The pin 4 function of the sensor can be configuredAdditional possible settings via IO-Link

¹⁾ Limit values.

²⁾ Signal transit time with resistive load in switching mode.

³⁾ With light/dark ratio 1:1.

⁴⁾ This switching output must not be connected to another output.

Mechanical data

Housing	Rectangular
Dimensions (W x H x D)	15.6 mm x 49.5 mm x 43.1 mm
Connection	Male connector M12, 4-pin
Material	
Housing	Metal, zinc diecast
Front screen	Plastic, PMMA
Male connector	Plastic, VISTAL®
Weight	Approx. 77 g
Maximum tightening torque of the fixing screws	1.4 Nm

Ambient data

Enclosure rating	IP66 (EN 60529) IP67 (EN 60529) IP69 (EN 60529)
Ambient operating temperature	-20 °C ... +55 °C
Ambient temperature, storage	-40 °C ... +70 °C
Warm-up time	< 15 min, Where T ₀ is under -10 °C
Typ. Ambient light immunity	Artificial light: ≤ 50,000 lx Sunlight: ≤ 50,000 lx
Shock resistance	50 g, 11 ms (25 positive and 25 negative shocks along X, Y, Z axes, 150 total shocks (EN60068-2-27))
Vibration resistance	10 Hz ... 2,000 Hz (Amplitude 0.5 mm / 10 g, 20 sweeps per axis, for X, Y, Z axes, 1 octave/min, (EN60068-2-6))
Air humidity	35 % ... 95 %, relative humidity (no condensation)
Electromagnetic compatibility (EMC)	EN 60947-5-2

Resistance to cleaning agent	ECOLAB
UL File No.	NRKH.E181493 & NRKH7.E181493

Smart Task

Smart Task name	Base logics
Logic function	Direct AND OR
Timer function	Deactivated Switch-on delay Off delay ON and OFF delay Impulse (one shot)
Inverter	Yes
Switching frequency	SIO Logic: 900 Hz (Mode 1, 2, 3) ¹⁾ SIO Logic: 450 Hz (Mode 4, 5) ¹⁾ SIO Logic: 30 Hz (Mode 1 and 6 combined) ¹⁾ IOL: 800 Hz (Mode 1, 2, 3) ²⁾ IOL: 450 Hz (Mode 4, 5) ²⁾ IOL: 30 Hz (Mode 1 and 6 combined) ²⁾
Response time	Mode 1, 2, 3 ¹⁾ SIO Logic: 1100 µs (Mode 4, 5) ¹⁾ SIO Logic: 15 ms (Mode 1 and 6 combined) ¹⁾ IOL: 600 µs (Mode 1, 2, 3) ²⁾ IOL: 1100 µs (Mode 4, 5) ²⁾ IOL: 15 ms (Mode 1 and 6 combined) ²⁾
Repeatability	SIO Logic: 200 µs (Mode 1, 2, 3) ¹⁾ SIO Logic: 400 µs (Mode 4, 5) ¹⁾ SIO Logic: 5 ms (Mode 1 and 6 combined) ¹⁾ IOL: 250 µs (Mode 1, 2, 3) ²⁾ IOL: 450 µs (Mode 4, 5) ²⁾ IOL: 5 ms (Mode 1 and 6 combined) ²⁾
Switching signal	
Switching signal Q_{L1}	Switching output
Switching signal \bar{Q}_{L1}	Switching output

¹⁾ Use of Smart Task functions without IO-Link communication (SIO mode).

²⁾ Use of Smart Task functions with IO-Link communication function.

Diagnosis

Device temperature	
Measuring range	Very cold, cold, moderate, warm, hot
Device status	Yes
Detailed device status	Yes
Operating hour counter	Yes
Operating hours counter with reset function	Yes
Quality of teach	Yes

Classifications

ECLASS 5.0	27270904
ECLASS 5.1.4	27270904

ECLASS 6.0	27270904
ECLASS 6.2	27270904
ECLASS 7.0	27270904
ECLASS 8.0	27270904
ECLASS 8.1	27270904
ECLASS 9.0	27270904
ECLASS 10.0	27270904
ECLASS 11.0	27270904
ECLASS 12.0	27270903
ETIM 5.0	EC002719
ETIM 6.0	EC002719
ETIM 7.0	EC002719
ETIM 8.0	EC002719
UNSPSC 16.0901	39121528

Adjustments

Display and adjustment elements

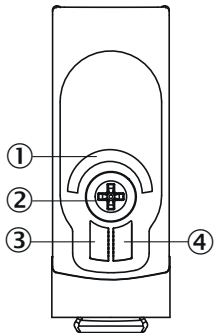

- ① LED blue
- ② Teach-Turn adjustment
- ③ LED green
- ④ LED yellow

Display and adjustment elements detail

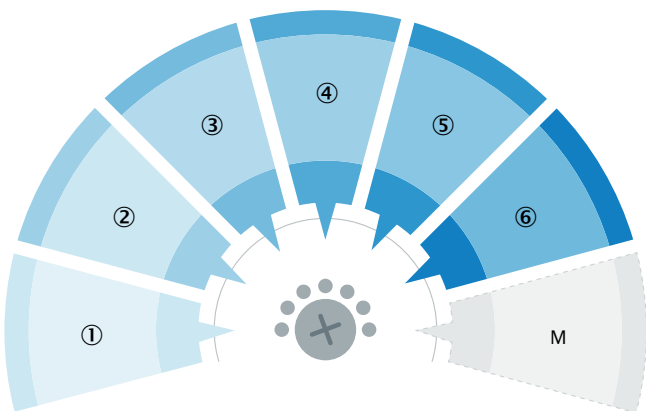

MultiMode settings	
1	Background suppression
2	Foreground suppression
3	Two-point teach-in
4	Two independent switching points
5	Window
6	ApplicationSelect
M	Manual / measurement

Connection type

M12 male connector, 4-pin

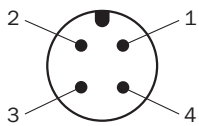

Truth table

Push-pull: PNP/NPN – dark switching \bar{Q}_L2 (MultiMode 4)

	Dark switching \bar{Q}_L2 (normally closed (upper switch), normally open (lower switch))	
	Object not present → Output HIGH	Object present → Output LOW
Light receive	✗	✓
Light receive indicator	✗	☀
Load resistance to L+	✗	⚠
Load resistance to M	⚠	✗

Push-pull: PNP/NPN – light switching Q_L2 (MultiMode 4)

	Light switching Q_L2 (normally open (upper switch), normally closed (lower switch))	
	Object not present → Output LOW	Object present → Output HIGH
Light receive	✗	✓
Light receive indicator	✗	☀
Load resistance to L+	⚠	✗
Load resistance to M	✗	⚠

Push-pull: PNP/NPN – dark switching \bar{Q}_L1 (MultiMode 4)

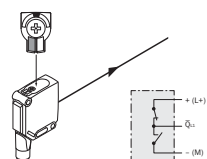
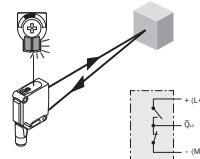
	Dark switching \bar{Q}_L1 (normally closed (upper switch), normally open (lower switch))	
	Object not present → Output HIGH	Object present → Output LOW
Light receive	✗	✓
Light receive indicator	✗	☉
Load resistance to L+	✗	⚠
Load resistance to M	⚠	✗
		

Push-pull: PNP/NPN – light switching Q_L1 (MultiMode 4)

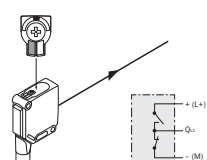
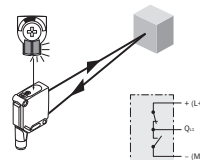
	Light switching Q_L1 (normally open (upper switch), normally closed (lower switch))	
	Object not present → Output LOW	Object present → Output HIGH
Light receive	✗	✓
Light receive indicator	✗	☉
Load resistance to L+	⚠	✗
Load resistance to M	✗	⚠
		

Push-pull: PNP/NPN – dark switching \bar{Q} (MultiMode 2)

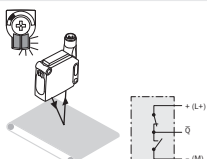
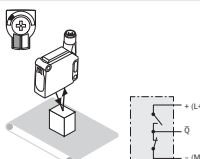
	Dark switching \bar{Q} (normally closed (upper switch), normally open (lower switch))	
	Object not present → Output HIGH	Object present → Output LOW
Light receive	✗	✓
Light receive indicator	✗	☉
Load resistance to L+	✗	⚠
Load resistance to M	⚠	✗
		

Push-pull: PNP/NPN – light switching Q (MultiMode 2)

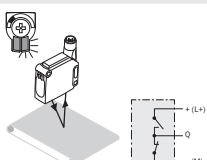
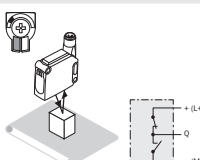
	Light switching Q (normally open (upper switch), normally closed (lower switch))	
	Object not present → Output LOW	Object present → Output HIGH
Light receive	✗	✓
Light receive indicator	✗	☉
Load resistance to L+	⚠	✗
Load resistance to M	✗	⚠
		

Push-pull: PNP/NPN – light switching Q (MultiMode 1, 3, 5, 6)

	Light switching Q (normally open (upper switch), normally closed (lower switch))	
	Object not present → Output LOW	Object present → Output HIGH
Light receive	⊗	⊙
Light receive indicator	⊗	⊙
Load resistance to L+	⚠	⊗
Load resistance to M	⊗	⚠

Push-pull: PNP/NPN – dark switching \bar{Q} (MultiMode 1, 3, 5, 6)

	Dark switching \bar{Q} (normally closed (upper switch), normally open (lower switch))	
	Object not present → Output HIGH	Object present → Output LOW
Light receive	⊗	⊙
Light receive indicator	⊗	⊙
Load resistance to L+	⊗	⚠
Load resistance to M	⚠	⊗

Characteristic curve

Mode 1, 3, 4, 5

Minimum distance in mm (y) between the set sensing range and white background (90 % remission)

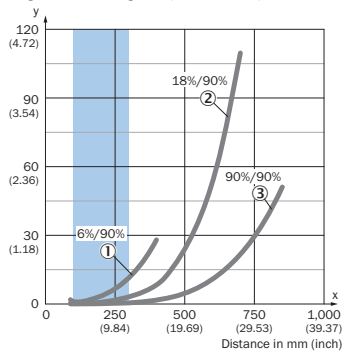

Example:
Safe suppression of the background

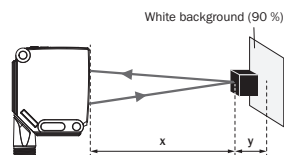

Black object (6 % remission)
Set sensing range $x = 250$ mm
Needed minimum distance to white background $y = 6$ mm

Recommended sensing range for the best performance

- ① Black object, 6% remission factor
- ② Gray object, 18% remission factor
- ③ White object, 90% remission factor

Mode 1 and 6 combined

Minimum distance in mm (y) between the set sensing range and white background (90 % remission)

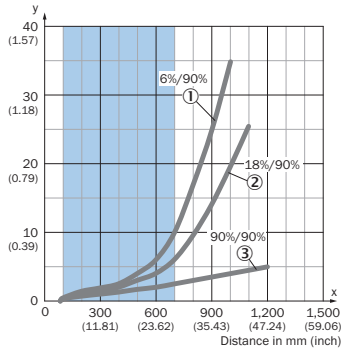

Recommended sensing range for the best performance

- ① Black object, 6% remission factor
- ② Gray object, 18% remission factor
- ③ White object, 90% remission factor

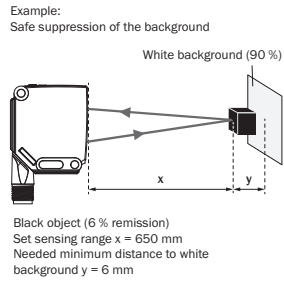

Mode 2

Minimum object height in mm (inch)

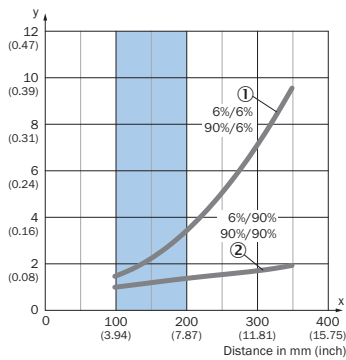

Recommended sensing range for the best performance

- ① Black background, 6% remission factor
- ② White background, 90% remission factor

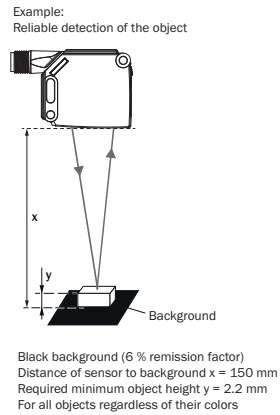

Light spot size

Mode 2

Dimensions in mm (inch)

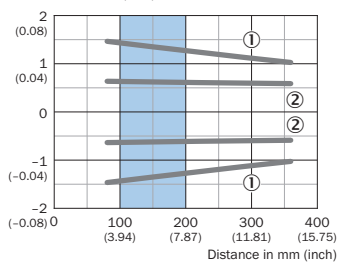

Recommended sensing range for the best performance

- ① Light spot horizontal
- ② Light spot vertical

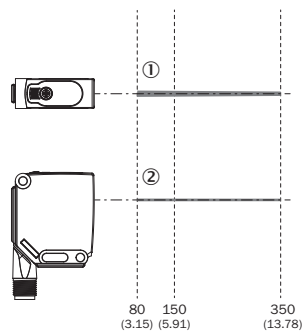

Mode 1 and 6 combined

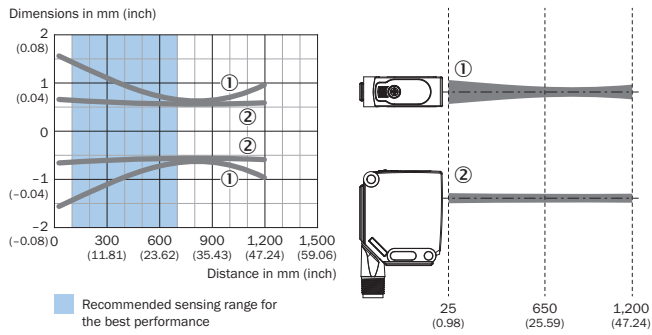

- ① Light spot horizontal
- ② Light spot vertical

Mode 1, 3, 4, 5

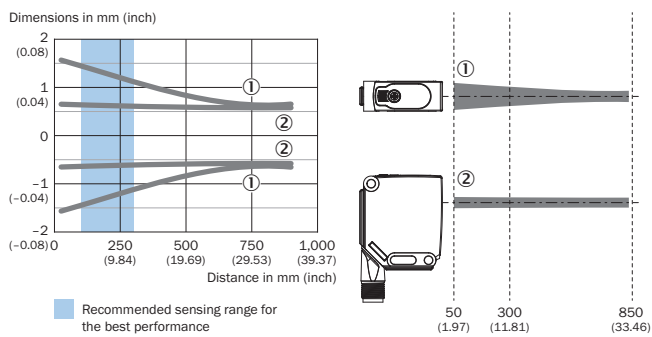

- ① Light spot horizontal
- ② Light spot vertical

Sensing range diagram

Mode 1, 3, 4, 5

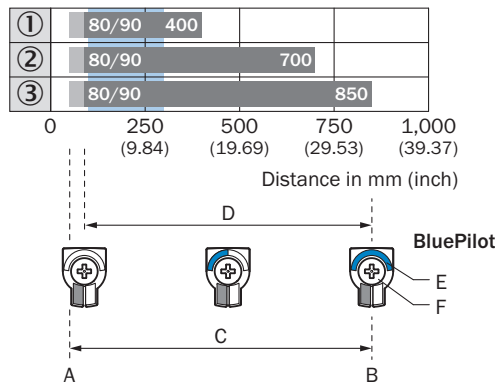

Recommended sensing range for the best performance

1	Black object, 6% remission factor
2	Gray object, 18% remission factor
3	White object, 90% remission factor
A	Sensing range min. in mm

B	Sensing range max. in mm
C	Field of view
D	Adjustable switching threshold for background suppression
E	Sensing range indicator
F	Teach-Turn adjustment

Mode 1 and 6 combined

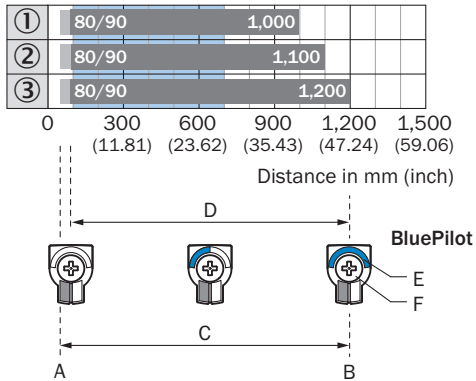

Recommended sensing range for the best performance

1	Black object, 6% remission factor
2	Gray object, 18% remission factor
3	White object, 90% remission factor
A	Sensing range min. in mm
B	Sensing range max. in mm
C	Field of view
D	Adjustable switching threshold for background suppression
E	Sensing range indicator
F	Teach-Turn adjustment

Mode 2

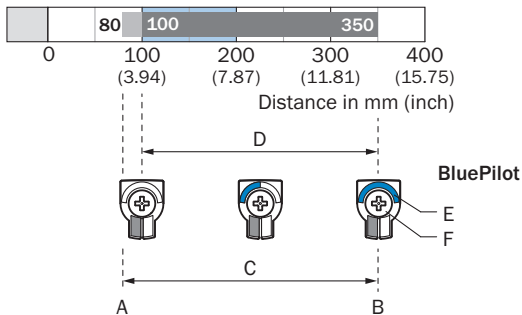

Recommended sensing range for the best performance

A	Sensing range min. in mm
B	Sensing range max. in mm

C	Field of view
D	Adjustable switching threshold for background suppression
E	Sensing range indicator
F	Teach-Turn adjustment

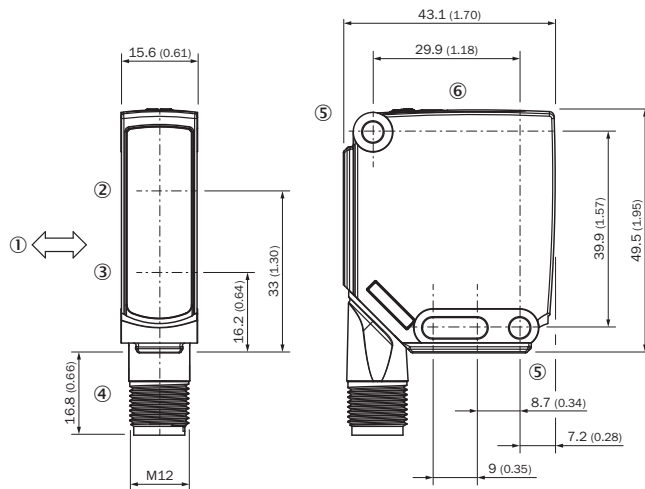

Dimensional drawing (Dimensions in mm (inch))







- ① Standard direction of the material being detected
- ② Center of optical axis, receiver
- ③ Center of optical axis, sender
- ④ Connection
- ⑤ Mounting hole, \varnothing 4.2 mm
- ⑥ Display and adjustment elements

Recommended accessories

Other models and accessories → www.sick.com/W12

	Brief description	Type	Part no.
Universal bar clamp systems			
	Plate N03 for universal clamp bracket, zinc coated, Zinc plated steel (sheet), Zinc die cast (clamping bracket), Universal clamp (5322626), mounting hardware	BEF-KHS-N03	2051609
	Mounting bar, straight, 300 mm, steel, steel, zinc coated, without mounting hardware	BEF-MS12G-B	4056055
	Bar clamp for bar diameter of 12 mm (fixing the mounting rod), Aluminum, 2 screws M6 x 30, 2 spring discs	BEF-RMC-D12	5321878

	Brief description	Type	Part no.
Mounting brackets and plates			
	Mounting bracket, large, stainless steel, mounting hardware included	BEF-WG-W12	2013942
	BEF-AP-W12	BEF-AP-W12	2127742
Terminal and alignment brackets			
	Clamping block for dovetail mounting, Aluminum (anodised), mounting hardware included	BEF-KH-W12	2013285
Others			
	<ul style="list-style-type: none"> • Connection type head A: Female connector, M12, 4-pin, straight, A-coded • Connection type head B: Flying leads • Signal type: Sensor/actuator cable • Cable: 5 m, 4-wire, PVC • Description: Sensor/actuator cable, unshielded • Application: Zones with chemicals 	YF2A14-050VB3XLEAX	2096235
Sensor Integration Gateway			
	<ul style="list-style-type: none"> • Further functions: Web server integrated, IIoT interface available (dual talk) • Logic editor: no • Communication interface: IO-Link, Ethernet, PROFINET, REST API, MQTT, OPC UA • Product category: IO-Link Master 	SIG350-0004AP100	6076871

SICK AT A GLANCE

SICK is one of the leading manufacturers of intelligent sensors and sensor solutions for industrial applications. A unique range of products and services creates the perfect basis for controlling processes securely and efficiently, protecting individuals from accidents and preventing damage to the environment.

We have extensive experience in a wide range of industries and understand their processes and requirements. With intelligent sensors, we can deliver exactly what our customers need. In application centers in Europe, Asia and North America, system solutions are tested and optimized in accordance with customer specifications. All this makes us a reliable supplier and development partner.

Comprehensive services complete our offering: SICK LifeTime Services provide support throughout the machine life cycle and ensure safety and productivity.

For us, that is “Sensor Intelligence.”

WORLDWIDE PRESENCE:

Contacts and other locations –www.sick.com