



# WTM4SP-1H162120A00

W4

MINIATURE PHOTOELECTRIC SENSORS

**SICK**  
Sensor Intelligence.



Illustration may differ

### Ordering information

Type	Part no.
WTM4SP-1H162120A00	1136369

Other models and accessories → [www.sick.com/W4](http://www.sick.com/W4)



### Detailed technical data

#### Features

<b>Functional principle</b>	Photoelectric proximity sensor
<b>Functional principle detail</b>	Background suppression, Foreground suppression, MultiMode
<b>MultiMode</b>	1 Background suppression 2 Foreground suppression 3 Two-point teach-in 4 Two independent switching points 5 Window 6 ApplicationSelect M manual / measurement
<b>Sensing range</b>	
Sensing range min.	4 mm (Mode 1, 3, 4, 5) 0 mm (Mode 2) 4 mm (Mode 1 and 6 combined)
Sensing range max.	250 mm (Mode 1, 3, 4, 5) 250 mm (Mode 2) 500 mm (Mode 1 and 6 combined)
Adjustable switching threshold for background suppression	10 mm ... 250 mm (Mode 1, 3, 4, 5) 10 mm ... 250 mm (Mode 2) 10 mm ... 500 mm (Mode 1 and 6 combined)
Reference object	Object with 90% remission factor (complies with standard white according to DIN 5033)

- 1) 90% remission factor.
- 2) Equivalent to 1  $\sigma$ .
- 3) See repeatability characteristic lines.

Minimum distance between set sensing range and background (black 6% / white 90%)	5 mm, at a distance of 150 mm (Mode 1, 3, 4, 5) 1.8 mm, at a distance of 100 mm (Mode 2) 8 mm, at a distance of 250 mm (Mode 1 and 6 combined)
Minimum object height at set sensing range in front of black background (6% remission factor)	1.8 mm, at a distance of 100 mm (Mode 2)
Recommended sensing range for the best performance	40 mm ... 170 mm (Mode 1, 3, 4, 5) 40 mm ... 140 mm (Mode 2) 50 mm ... 200 mm (Mode 1 and 6 combined)
<b>Distance value</b>	
Measuring range	10 mm ... 250 mm
Resolution	0.1 mm
Repeatability	0,2 mm ... 6 mm <sup>1) 2) 3)</sup>
Accuracy	Typ. 5.0 mm at 10 ... 50 mm distance, Typ. 6.0 mm at 15 ... 100 mm distance, Typ. 8.0 mm at 100 ... 150 mm distance, Typ. 12 mm at 150 ... 200 mm distance, Typ. 16 mm at 200 ... 250 mm distance <sup>1) 1) 1) 1) 1)</sup>
Distance value output	Via IO-Link
Update rate of the distance value	20 ms
<b>Emitted beam</b>	
Light source	PinPoint LED
Type of light	Visible red light
Shape of light spot	Point-shaped
Light spot size (distance)	4 mm (150 mm)
Maximum dispersion of the emitted beam around the standardized transmission axis (squint angle)	< +/- 1.5° (at T <sub>a</sub> = +23 °C)
<b>Key LED figures</b>	
Normative reference	EN 62471:2008-09   IEC 62471:2006, modified
LED risk group marking	Free group
Wave length	635 nm
Average service life	100,000 h at T <sub>a</sub> = +25 °C
<b>Smallest detectable object (MDO) typ.</b>	
	0.2 mm (At 180 mm distance, Mode 1, 3, 4, 5) 0.6 mm (at a distance of 140 mm, Mode 2) 0.1 mm (At 180 mm distance, Mode 1 and 6 combined) Object with 90% remission factor (complies with standard white according to DIN 5033)
<b>Adjustment</b>	
Teach-Turn adjustment	BluePilot: For adjusting the sensing range with mode selection
IO-Link	For configuring the sensor parameters and Smart Task functions
<b>Indication</b>	
LED blue	BluePilot: Display of mode, display of output states Q <sub>L1</sub> (LED 3 permanently on) and Q <sub>L2</sub> (LED 5 permanently on)
LED green	Operating indicator Static on: power on Flashing: IO-Link mode
LED yellow	Status of received light beam Static on: object present

1) 90% remission factor.  
2) Equivalent to 1  $\sigma$ .  
3) See repeatability characteristic lines.

	Static off: object not present
<b>Special features</b>	MultiMode
<b>Special applications</b>	Detecting uneven, shiny objects, Detection of poorly remitting and tilted objects

- <sup>1)</sup> 90% remission factor.
- <sup>2)</sup> Equivalent to 1  $\sigma$ .
- <sup>3)</sup> See repeatability characteristic lines.

### Safety-related parameters

<b>MTTF<sub>D</sub></b>	1,404 years
<b>DC<sub>avg</sub></b>	0%

### Communication interface

<b>IO-Link</b>	✓, IO-Link V1.1
Data transmission rate	COM2 (38,4 kBaud)
Cycle time	2.3 ms
Process data length	16 Bit
Process data structure	Bit 0 = switching signal Q <sub>L1</sub> Bit 1 = switching signal Q <sub>L2</sub> Process data structure: Bit 2 ... 15 = current receiver level (live) mode 1-5. Process data structure B: Bit 2 ... 15 = distance value 0.1 mm (live) mode M.
VendorID	26
DeviceID HEX	0x800336
DeviceID DEC	8389430
Compatible master port type	A
SIO mode support	Yes

### Electrical data

<b>Supply voltage U<sub>B</sub></b>	10 V DC ... 30 V DC <sup>1)</sup>
<b>Ripple</b>	≤ 5 V <sub>pp</sub>
<b>Usage category</b>	DC-12 (According to EN 60947-5-2) DC-13 (According to EN 60947-5-2)
<b>Current consumption</b>	≤ 20 mA, without load. At U <sub>B</sub> = 24 V
<b>Protection class</b>	III
<b>Digital output</b>	
Number	2
Type	Push-pull: PNP/NPN
Switching mode	Light/dark switching
Signal voltage PNP HIGH/LOW	Approx. U <sub>B</sub> -2.5 V / 0 V
Signal voltage NPN HIGH/LOW	Approx. U <sub>B</sub> / < 2.5 V
Output current I <sub>max.</sub>	≤ 100 mA
Circuit protection outputs	Reverse polarity protected Overcurrent protected Short-circuit protected

- <sup>1)</sup> Limit values.
- <sup>2)</sup> Signal transit time with resistive load in switching mode.
- <sup>3)</sup> With light/dark ratio 1:1.
- <sup>4)</sup> This switching output must not be connected to another output.

Response time	≤ 500 μs, ≤ 1,000 μs, ≤ 15 ms (Mode 1, 2, 3, Mode 4, 5, Mode 1 and 6 combined) <sup>2) 2) 2)</sup>
Repeatability (response time)	500 μs (Mode 1, 2, 3) <sup>2)</sup> 350 μs (Mode 4, 5) <sup>2)</sup> 5 ms (Mode 1 and 6 combined) <sup>2)</sup>
Switching frequency	1,000 Hz, 500 Hz, 30 Hz (Mode 1, 2, 3, Mode 4, 5, Mode 1 and 6 combined) <sup>3) 3) 3)</sup>
<b>Pin/Wire assignment</b>	
Function of pin 4/black (BK)	Digital output, dark switching, object present → output QL1 LOW (Mode 1, 3, 4, 5, 6). digital output, dark switching, object present → output QL1 HIGH (Mode 2), IO-Link communication C <sup>4)</sup>
Function of pin 4/black (BK) – detail	The pin 4 function of the sensor can be configured, Additional possible settings via IO-Link
Function of pin 2/white (WH)	Digital output, light switching, object present → output QL1 HIGH (Mode 1, 3, 5, 6). digital output, light switching, object present → output QL1 LOW (Mode 2). digital output, dark switching, object present → output QL2 LOW (Mode 4). <sup>4)</sup>
Function of pin 2/white (WH) – detail	The pin 2 function of the sensor can be configured, Additional possible settings via IO-Link

<sup>1)</sup> Limit values.

<sup>2)</sup> Signal transit time with resistive load in switching mode.

<sup>3)</sup> With light/dark ratio 1:1.

<sup>4)</sup> This switching output must not be connected to another output.

## Mechanical data

<b>Housing</b>	Rectangular
<b>Design detail</b>	Slim
<b>Dimensions (W x H x D)</b>	12.1 mm x 41.9 mm x 18.6 mm
<b>Connection</b>	Cable, 4-wire, 2 m
<b>Connection detail</b>	
Deep-freeze property	Do not bend below 0 °C
Conductor size	0.14 mm <sup>2</sup>
Cable diameter	Ø 3.4 mm
Length of cable (L)	2 m
<b>Material</b>	
Housing	Plastic, VISTAL®
Front screen	Plastic, PMMA
Cable	Plastic, PVC
<b>Maximum tightening torque of the fixing screws</b>	0.4 Nm

## Ambient data

<b>Enclosure rating</b>	IP66 (EN 60529) IP67 (EN 60529)
<b>Ambient operating temperature</b>	-40 °C ... +60 °C
<b>Ambient temperature, storage</b>	-40 °C ... +75 °C
<b>Typ. Ambient light immunity</b>	Artificial light: ≤ 50,000 lx Sunlight: ≤ 50,000 lx
<b>Shock resistance</b>	30 g, 11 ms (3 positive and 3 negative shocks along X, Y, Z axes, 18 total shocks (EN60068-2-27))
<b>Vibration resistance</b>	10 Hz ... 1,000 Hz (Amplitude 1 mm, 3 x 30 min (EN60068-2-6))
<b>Air humidity</b>	35 % ... 95 %, relative humidity (no condensation)

<b>Electromagnetic compatibility (EMC)</b>	EN 60947-5-2
<b>Resistance to cleaning agent</b>	ECOLAB
<b>UL File No.</b>	NRKH.E181493 & NRKH7.E181493

### Smart Task

<b>Smart Task name</b>	Base logics
<b>Logic function</b>	Direct AND OR
<b>Timer function</b>	Deactivated Switch-on delay Off delay ON and OFF delay Impulse (one shot)
<b>Inverter</b>	Yes
<b>Switching frequency</b>	SIO Logic: 900 Hz (Mode 1, 2, 3) <sup>1)</sup> SIO Logic: 450 Hz (Mode 4, 5) <sup>1)</sup> SIO Logic: 30 Hz (Mode 1 and 6 combined) <sup>1)</sup> IOL: 800 Hz (Mode 1, 2, 3) <sup>2)</sup> IOL: 450 Hz (Mode 4, 5) <sup>2)</sup> IOL: 30 Hz (Mode 1 and 6 combined) <sup>2)</sup>
<b>Response time</b>	SIO Logic: 550 μs (Mode 1, 2, 3) <sup>1)</sup> SIO Logic: 1100 μs (Mode 4, 5) <sup>1)</sup> SIO Logic: 15 ms (Mode 1 and 6 combined) <sup>1)</sup> IOL: 600 μs (Mode 1, 2, 3) <sup>2)</sup> IOL: 1100 μs (Mode 4, 5) <sup>2)</sup> IOL: 15 ms (Mode 1 and 6 combined) <sup>2)</sup>
<b>Repeatability</b>	SIO Logic: 200 μs <sup>1)</sup> SIO Logic: 400 μs <sup>1)</sup> SIO Logic: 5 ms <sup>1)</sup> IOL: 250 μs <sup>2)</sup> IOL: 450 μs <sup>2)</sup> IOL: 5 ms <sup>2)</sup>
<b>Switching signal</b>	
Switching signal $Q_{L1}$	Switching output
Switching signal $\bar{Q}_{L1}$	Switching output

<sup>1)</sup> Use of Smart Task functions without IO-Link communication (SIO mode).

<sup>2)</sup> Use of Smart Task functions with IO-Link communication function.

### Diagnosis

<b>Device temperature</b>	
Measuring range	Very cold, cold, moderate, warm, hot
<b>Device status</b>	Yes
<b>Detailed device status</b>	Yes
<b>Operating hour counter</b>	Yes
<b>Operating hours counter with reset function</b>	Yes
<b>Quality of teach</b>	Yes

### Classifications

<b>ECLASS 5.0</b>	27270904
-------------------	----------

<b>ECLASS 5.1.4</b>	27270904
<b>ECLASS 6.0</b>	27270904
<b>ECLASS 6.2</b>	27270904
<b>ECLASS 7.0</b>	27270904
<b>ECLASS 8.0</b>	27270904
<b>ECLASS 8.1</b>	27270904
<b>ECLASS 9.0</b>	27270904
<b>ECLASS 10.0</b>	27270904
<b>ECLASS 11.0</b>	27270904
<b>ECLASS 12.0</b>	27270903
<b>ETIM 5.0</b>	EC002719
<b>ETIM 6.0</b>	EC002719
<b>ETIM 7.0</b>	EC002719
<b>ETIM 8.0</b>	EC002719
<b>UNSPSC 16.0901</b>	39121528

## Adjustments

Display and adjustment elements

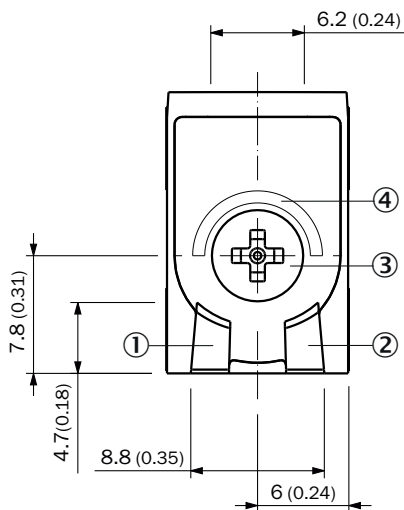

- ① LED green
- ② LED yellow
- ③ Teach-Turn adjustment
- ④ LED blue

Display and adjustment elements detail

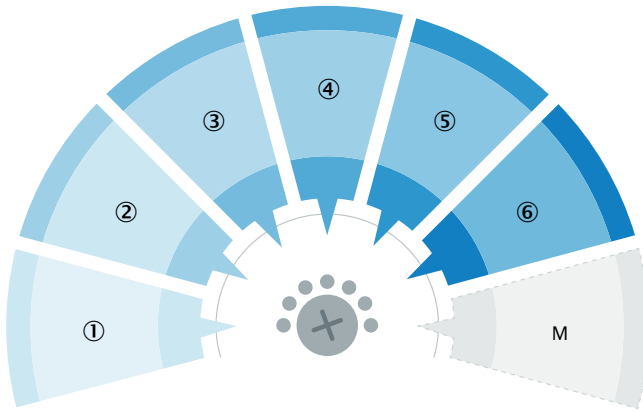

MultiMode settings	
1	Background suppression
2	Foreground suppression
3	Two-point teach-in
4	Two independent switching points
5	Window
6	ApplicationSelect
M	Manual / measurement

### Connection type

Cable, 4-wire

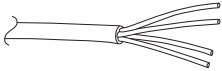

### Connection diagram

Cd-504

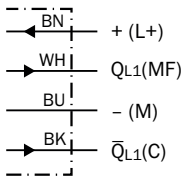



## Truth table

Push-pull: PNP/NPN – dark switching  $\bar{Q}$

	Dark switching Q (normally closed (upper switch), normally open (lower switch))	
	Object not present → Output HIGH	Object present → Output LOW
Light receive	✗	✓
Light receive indicator	✗	☉
Load resistance to L+	✗	⚠
Load resistance to M	⚠	✗

Push-pull: PNP/NPN - light switching Q

	Light switching Q (normally open (upper switch), normally closed (lower switch))	
	Object not present → Output LOW	Object present → Output HIGH
Light receive	✗	✓
Light receive indicator	✗	☉
Load resistance to L+	⚠	✗
Load resistance to M	✗	⚠

## Characteristic curve

Mode 2

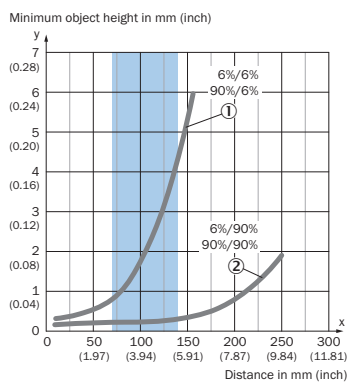

Example:  
Reliable detection of the object

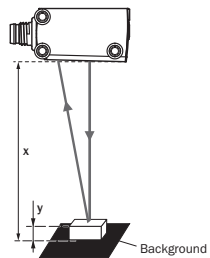

Black background (6 % remission factor)  
Distance of sensor to background  $x = 100$  mm  
Required minimum object height  $y = 1.9$  mm  
For all objects regardless of their colors

Recommended sensing range for the best performance

- ① Black background, 6% remission factor
- ② White background, 90% remission factor

### Mode 1 and 6 combined

Minimum distance in mm (y) between the set sensing range and white background (90 % remission factor)

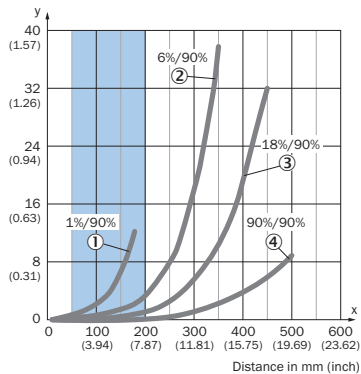

Recommended sensing range for the best performance

- ① Ultra-black object, 1% remission factor
- ② Black object, 6% remission factor
- ③ Gray object, 18% remission factor
- ④ White object, 90% remission factor

Example:  
Safe suppression of the background

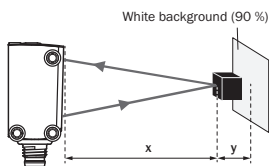

Black object (6 % remission factor)  
Set sensing range  $x = 300$  mm  
Needed minimum distance to white background  $y = 17$  mm

### Mode 1, 3, 4, 5

Minimum distance in mm (y) between the set sensing range and white background (90 % remission factor)

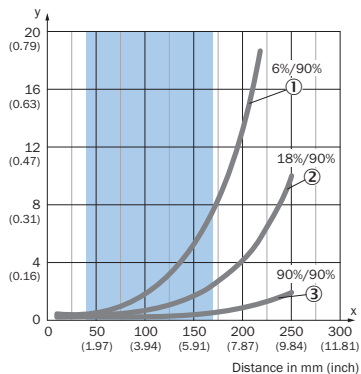

Recommended sensing range for the best performance

- ① Black object, 6% remission factor
- ② Gray object, 18% remission factor
- ③ White object, 90% remission factor

Example:  
Safe suppression of the background

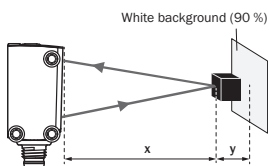

Black object (6 % remission factor)  
Set sensing range  $x = 150$  mm  
Needed minimum distance to white background  $y = 5.5$  mm

## Light spot size

### Mode 2

Dimensions in mm (inch)

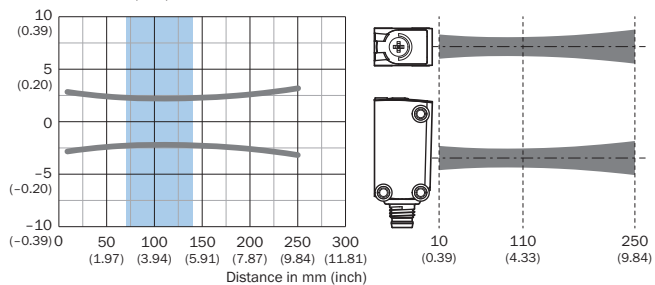

Recommended sensing range for the best performance

### Mode 1 and 6 combined

Dimensions in mm (inch)

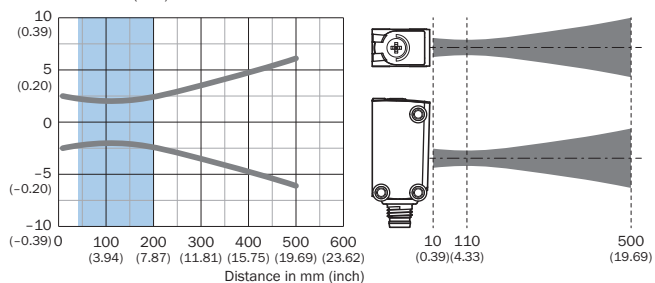

Recommended sensing range for the best performance

### Mode 1, 3, 4, 5

Dimensions in mm (inch)

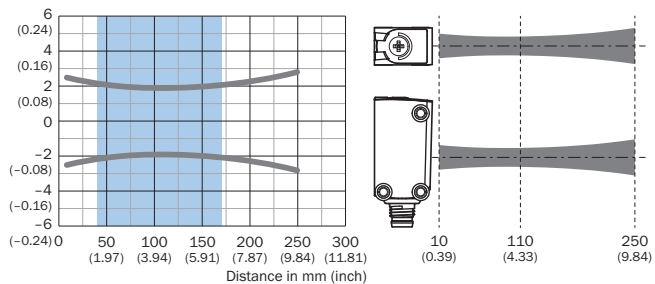

Recommended sensing range for the best performance

### Sensing range diagram

Mode 2

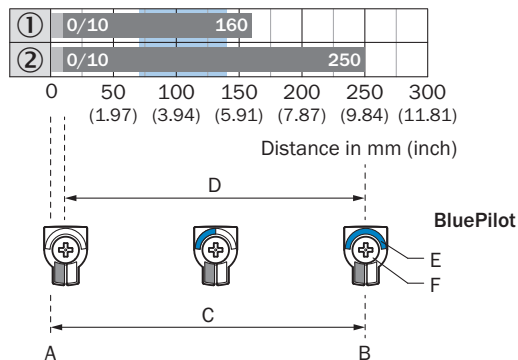

Recommended sensing range for the best performance

1	Black background, 6% remission factor
2	White background, 90% remission factor
A	Sensing range min. in mm
B	Sensing range max. in mm
C	Field of view
D	Adjustable switching threshold for foreground suppression
E	Sensing range indicator
F	Teach-Turn adjustment

Mode 1 and 6 combined

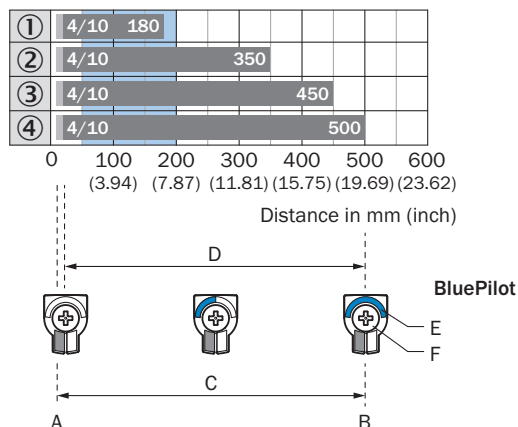

Recommended sensing range for the best performance

1	Ultra-black object, 1% remission factor
2	Black object, 6% remission factor
3	Gray object, 18% remission factor
4	White object, 90% remission factor
A	Sensing range min. in mm
B	Sensing range max. in mm

C	Field of view
D	Adjustable switching threshold for background suppression
E	Sensing range indicator
F	Teach-Turn adjustment

Mode 1, 3, 4, 5

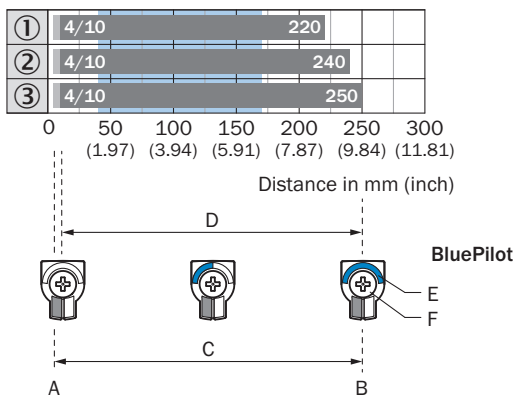

Recommended sensing range for the best performance

1	Black object, 6% remission factor
2	Gray object, 18% remission factor
3	White object, 90% remission factor
A	Sensing range min. in mm
B	Sensing range max. in mm
C	Field of view
D	Adjustable switching threshold for background suppression
E	Sensing range indicator
F	Teach-Turn adjustment

**Dimensional drawing** (Dimensions in mm (inch))

Dimensional drawing, sensor

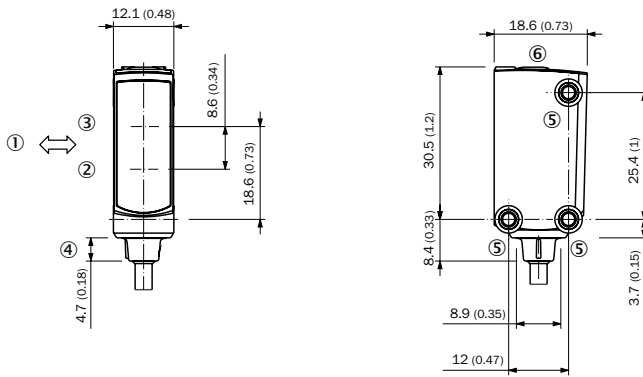

- ① Standard direction of the material being detected
- ② Center of optical axis, sender
- ③ Center of optical axis, receiver
- ④ Connection
- ⑤ M3 mounting hole
- ⑥ Display and adjustment elements

## SICK AT A GLANCE

SICK is one of the leading manufacturers of intelligent sensors and sensor solutions for industrial applications. A unique range of products and services creates the perfect basis for controlling processes securely and efficiently, protecting individuals from accidents and preventing damage to the environment.

We have extensive experience in a wide range of industries and understand their processes and requirements. With intelligent sensors, we can deliver exactly what our customers need. In application centers in Europe, Asia and North America, system solutions are tested and optimized in accordance with customer specifications. All this makes us a reliable supplier and development partner.

Comprehensive services complete our offering: SICK LifeTime Services provide support throughout the machine life cycle and ensure safety and productivity.

For us, that is “Sensor Intelligence.”

## WORLDWIDE PRESENCE:

Contacts and other locations – [www.sick.com](http://www.sick.com)