



WTM4SP-22161120A00

W4

MINIATURE PHOTOELECTRIC SENSORS

SICK
Sensor Intelligence.



Illustration may differ



Ordering information

Type	Part no.
WTM4SP-22161120A00	1131619

Other models and accessories → www.sick.com/W4

Detailed technical data

Features

Functional principle	Photoelectric proximity sensor
Functional principle detail	Background suppression, Foreground suppression, MultiMode
MultiMode	1 Background suppression 2 Foreground suppression 3 Two-point teach-in 4 Two independent switching points 5 Window 6 ApplicationSelect M manual / measurement
Sensing range	
Sensing range min.	4 mm (Mode 1, 3, 4, 5) 0 mm (Mode 2) 4 mm (Mode 1 and 6 combined)
Sensing range max.	250 mm (Mode 1, 3, 4, 5) 250 mm (Mode 2) 500 mm (Mode 1 and 6 combined)
Adjustable switching threshold for background suppression	10 mm ... 250 mm (Mode 1, 3, 4, 5) 10 mm ... 250 mm (Mode 2) 10 mm ... 500 mm (Mode 1 and 6 combined)
Reference object	Object with 90% remission factor (complies with standard white according to DIN 5033)

- 1) 90% remission factor.
 2) Equivalent to 1 σ .
 3) See repeatability characteristic lines.

Minimum distance between set sensing range and background (black 6% / white 90%)	5 mm, at a distance of 150 mm (Mode 1, 3, 4, 5) 1.8 mm, at a distance of 100 mm (Mode 2) 8 mm, at a distance of 250 mm (Mode 1 and 6 combined)
Minimum object height at set sensing range in front of black background (6% remission factor)	1.8 mm, at a distance of 100 mm (Mode 2)
Recommended sensing range for the best performance	40 mm ... 170 mm (Mode 1, 3, 4, 5) 40 mm ... 140 mm (Mode 2) 50 mm ... 200 mm (Mode 1 and 6 combined)
Distance value	
Measuring range	10 mm ... 250 mm
Resolution	0.1 mm
Repeatability	0,2 mm ... 6 mm ^{1) 2) 3)}
Accuracy	Typ. 5.0 mm at 10 ... 50 mm distance, Typ. 6.0 mm at 15 ... 100 mm distance, Typ. 8.0 mm at 100 ... 150 mm distance, Typ. 12 mm at 150 ... 200 mm distance, Typ. 16 mm at 200 ... 250 mm distance ^{1) 1) 1) 1) 1)}
Distance value output	Via IO-Link
Update rate of the distance value	20 ms
Emitted beam	
Light source	PinPoint LED
Type of light	Visible red light
Shape of light spot	Point-shaped
Light spot size (distance)	4 mm (150 mm)
Maximum dispersion of the emitted beam around the standardized transmission axis (squint angle)	< +/- 1.5° (at T _a = +23 °C)
Key LED figures	
Normative reference	EN 62471:2008-09 IEC 62471:2006, modified
LED risk group marking	Free group
Wave length	635 nm
Average service life	100,000 h at T _a = +25 °C
Smallest detectable object (MDO) typ.	
	0.2 mm (At 180 mm distance, Mode 1, 3, 4, 5) 0.6 mm (at a distance of 140 mm, Mode 2) 0.1 mm (At 180 mm distance, Mode 1 and 6 combined) Object with 90% remission factor (complies with standard white according to DIN 5033)
Adjustment	
Teach-Turn adjustment	BluePilot: For adjusting the sensing range with mode selection
IO-Link	For configuring the sensor parameters and Smart Task functions
Indication	
LED blue	BluePilot: Display of mode, display of output states Q _{L1} (LED 3 permanently on) and Q _{L2} (LED 5 permanently on)
LED green	Operating indicator Static on: power on Flashing: IO-Link mode
LED yellow	Status of received light beam Static on: object present

¹⁾ 90% remission factor.

²⁾ Equivalent to 1 σ .

³⁾ See repeatability characteristic lines.

	Static off: object not present
Special features	MultiMode
Special applications	Detecting uneven, shiny objects, Detection of poorly remitting and tilted objects

- ¹⁾ 90% remission factor.
- ²⁾ Equivalent to 1 σ .
- ³⁾ See repeatability characteristic lines.

Safety-related parameters

MTTF_D	1,404 years
DC_{avg}	0%

Communication interface

IO-Link	✓, IO-Link V1.1
Data transmission rate	COM2 (38,4 kBaud)
Cycle time	2.3 ms
Process data length	16 Bit
Process data structure	Bit 0 = switching signal Q _{L1} Bit 1 = switching signal Q _{L2} Process data structure: Bit 2 ... 15 = current receiver level (live) mode 1-5. Process data structure B: Bit 2 ... 15 = distance value 0.1 mm (live) mode M.
VendorID	26
DeviceID HEX	0x80031A
DeviceID DEC	8389402
Compatible master port type	A
SIO mode support	Yes

Electrical data

Supply voltage U_B	10 V DC ... 30 V DC ¹⁾
Ripple	≤ 5 V _{pp}
Usage category	DC-12 (According to EN 60947-5-2) DC-13 (According to EN 60947-5-2)
Current consumption	≤ 20 mA, without load. At U _B = 24 V
Protection class	III
Digital output	
Number	2
Type	Push-pull: PNP/NPN
Switching mode	Light/dark switching
Signal voltage PNP HIGH/LOW	Approx. U _B -2.5 V / 0 V
Signal voltage NPN HIGH/LOW	Approx. U _B / < 2.5 V
Output current I _{max.}	≤ 100 mA
Circuit protection outputs	Reverse polarity protected Overcurrent protected Short-circuit protected

- ¹⁾ Limit values.
- ²⁾ Signal transit time with resistive load in switching mode.
- ³⁾ With light/dark ratio 1:1.
- ⁴⁾ This switching output must not be connected to another output.

Response time	≤ 500 μs, ≤ 1,000 μs, ≤ 15 ms (Mode 1, 2, 3, Mode 4, 5, Mode 1 and 6 combined) ^{2) 2) 2)}
Repeatability (response time)	500 μs (Mode 1, 2, 3) ²⁾ 350 μs (Mode 4, 5) ²⁾ 5 ms (Mode 1 and 6 combined) ²⁾
Switching frequency	1,000 Hz, 500 Hz, 30 Hz (Mode 1, 2, 3, Mode 4, 5, Mode 1 and 6 combined) ^{3) 3) 3)}
Pin/Wire assignment	
Function of pin 4/black (BK)	Digital output, light switching, object present → output QL1 HIGH (Mode 1, 3, 4, 5, 6). digital output, light switching, object present → output QL1 LOW (Mode 2), IO-Link communication C ⁴⁾
Function of pin 4/black (BK) – detail	The pin 4 function of the sensor can be configured, Additional possible settings via IO-Link
Function of pin 2/white (WH)	Digital output, dark switching, object present → output \bar{Q} L1 LOW (Mode 1, 3, 5, 6). digital output, dark switching, object present → output \bar{Q} L1 HIGH (Mode 2). digital output, light switching, object present → output QL2 HIGH (Mode 4). ⁴⁾
Function of pin 2/white (WH) – detail	The pin 2 function of the sensor can be configured, Additional possible settings via IO-Link

¹⁾ Limit values.

²⁾ Signal transit time with resistive load in switching mode.

³⁾ With light/dark ratio 1:1.

⁴⁾ This switching output must not be connected to another output.

Mechanical data

Housing	Rectangular
Design detail	Slim
Dimensions (W x H x D)	12.1 mm x 41.9 mm x 18.6 mm
Connection	Male connector M8, 4-pin
Material	
Housing	Plastic, VISTAL®
Front screen	Plastic, PMMA
Male connector	Plastic, VISTAL®
Maximum tightening torque of the fixing screws	0.4 Nm

Ambient data

Enclosure rating	IP66 (EN 60529) IP67 (EN 60529)
Ambient operating temperature	-40 °C ... +60 °C
Ambient temperature, storage	-40 °C ... +75 °C
Typ. Ambient light immunity	Artificial light: ≤ 50,000 lx Sunlight: ≤ 50,000 lx
Shock resistance	30 g, 11 ms (3 positive and 3 negative shocks along X, Y, Z axes, 18 total shocks (EN60068-2-27))
Vibration resistance	10 Hz ... 1,000 Hz (Amplitude 1 mm, 3 x 30 min (EN60068-2-6))
Air humidity	35 % ... 95 %, relative humidity (no condensation)
Electromagnetic compatibility (EMC)	EN 60947-5-2
Resistance to cleaning agent	ECOLAB
UL File No.	NRKH.E181493 & NRKH7.E181493

Smart Task

Smart Task name	Base logics
Logic function	Direct AND OR
Timer function	Deactivated Switch-on delay Off delay ON and OFF delay Impulse (one shot)
Inverter	Yes
Switching frequency	SIO Logic: 900 Hz (Mode 1, 2, 3) ¹⁾ SIO Logic: 450 Hz (Mode 4, 5) ¹⁾ SIO Logic: 30 Hz (Mode 1 and 6 combined) ¹⁾ IOL: 800 Hz (Mode 1, 2, 3) ²⁾ IOL: 450 Hz (Mode 4, 5) ²⁾ IOL: 30 Hz (Mode 1 and 6 combined) ²⁾
Response time	SIO Logic: 550 µs (Mode 1, 2, 3) ¹⁾ SIO Logic: 1100 µs (Mode 4, 5) ¹⁾ SIO Logic: 15 ms (Mode 1 and 6 combined) ¹⁾ IOL: 600 µs (Mode 1, 2, 3) ²⁾ IOL: 1100 µs (Mode 4, 5) ²⁾ IOL: 15 ms (Mode 1 and 6 combined) ²⁾
Repeatability	SIO Logic: 200 µs ¹⁾ SIO Logic: 400 µs ¹⁾ SIO Logic: 5 ms ¹⁾ IOL: 250 µs ²⁾ IOL: 450 µs ²⁾ IOL: 5 ms ²⁾
Switching signal	
Switching signal Q_{L1}	Switching output
Switching signal \bar{Q}_{L1}	Switching output

¹⁾ Use of Smart Task functions without IO-Link communication (SIO mode).

²⁾ Use of Smart Task functions with IO-Link communication function.

Diagnosis

Device temperature	
Measuring range	Very cold, cold, moderate, warm, hot
Device status	Yes
Detailed device status	Yes
Operating hour counter	Yes
Operating hours counter with reset function	Yes
Quality of teach	Yes

Classifications

ECLASS 5.0	27270904
ECLASS 5.1.4	27270904
ECLASS 6.0	27270904
ECLASS 6.2	27270904

ECLASS 7.0	27270904
ECLASS 8.0	27270904
ECLASS 8.1	27270904
ECLASS 9.0	27270904
ECLASS 10.0	27270904
ECLASS 11.0	27270904
ECLASS 12.0	27270903
ETIM 5.0	EC002719
ETIM 6.0	EC002719
ETIM 7.0	EC002719
ETIM 8.0	EC002719
UNSPSC 16.0901	39121528

Adjustments

Display and adjustment elements

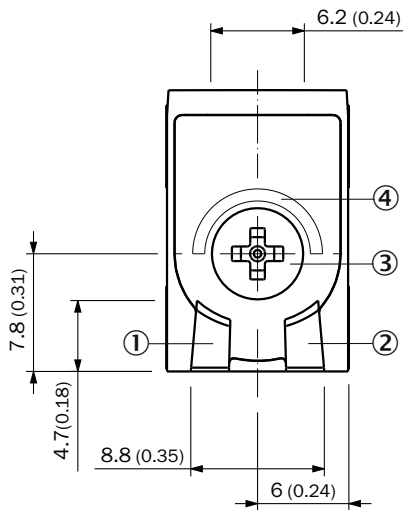

- ① LED green
- ② LED yellow
- ③ Teach-Turn adjustment
- ④ LED blue

Display and adjustment elements detail

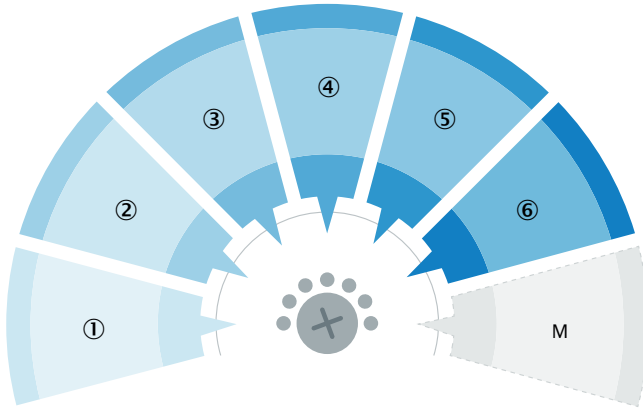

MultiMode settings	
1	Background suppression
2	Foreground suppression
3	Two-point teach-in
4	Two independent switching points
5	Window
6	ApplicationSelect
M	Manual / measurement

Connection type

Male connector M8, 4-pin

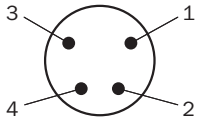

Connection diagram

Cd-503

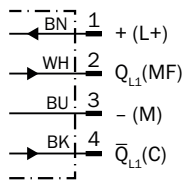

Truth table

Push-pull: PNP/NPN – dark switching \bar{Q}

	Dark switching Q (normally closed (upper switch), normally open (lower switch))	
	Object not present → Output HIGH	Object present → Output LOW
Light receive	✗	✓
Light receive indicator	✗	☉
Load resistance to L+	✗	⚠
Load resistance to M	⚠	✗

Push-pull: PNP/NPN - light switching Q

	Light switching Q (normally open (upper switch), normally closed (lower switch))	
	Object not present → Output LOW	Object present → Output HIGH
Light receive	✗	✓
Light receive indicator	✗	☉
Load resistance to L+	⚠	✗
Load resistance to M	✗	⚠

Characteristic curve

Mode 2

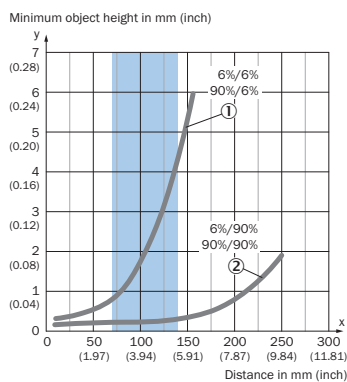

Example:
Reliable detection of the object

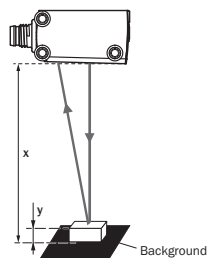

Black background (6 % remission factor)
Distance of sensor to background $x = 100$ mm
Required minimum object height $y = 1.9$ mm
For all objects regardless of their colors

- ① Black background, 6% remission factor
- ② White background, 90% remission factor

Mode 1 and 6 combined

Minimum distance in mm (y) between the set sensing range and white background (90 % remission factor)

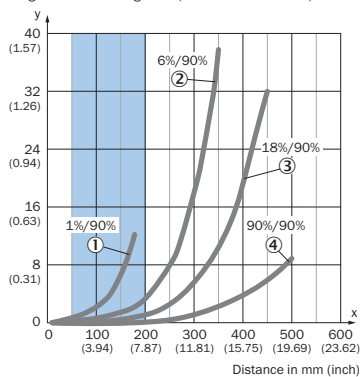

Example:
Safe suppression of the background

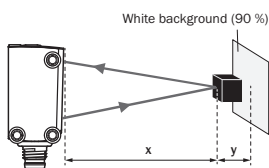

Black object (6 % remission factor)
 Set sensing range x = 300 mm
 Needed minimum distance to white background y = 17 mm

Recommended sensing range for the best performance

- ① Ultra-black object, 1% remission factor
- ② Black object, 6% remission factor
- ③ Gray object, 18% remission factor
- ④ White object, 90% remission factor

Mode 1, 3, 4, 5

Minimum distance in mm (y) between the set sensing range and white background (90 % remission factor)

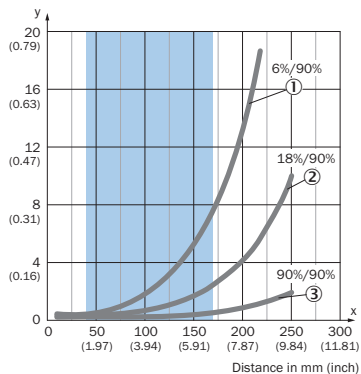

Example:
Safe suppression of the background

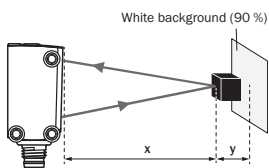

Black object (6 % remission factor)
 Set sensing range x = 150 mm
 Needed minimum distance to white background y = 5.5 mm

Recommended sensing range for the best performance

- ① Black object, 6% remission factor
- ② Gray object, 18% remission factor
- ③ White object, 90% remission factor

Light spot size

Mode 2

Dimensions in mm (inch)

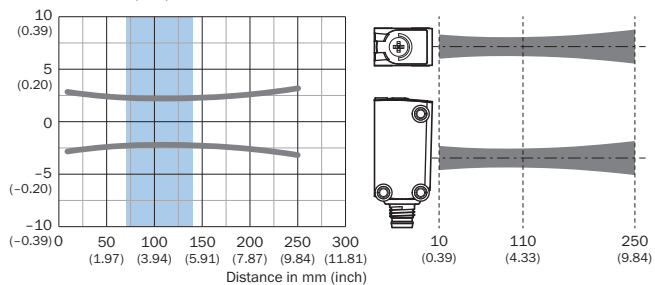

Recommended sensing range for the best performance

Mode 1 and 6 combined

Dimensions in mm (inch)

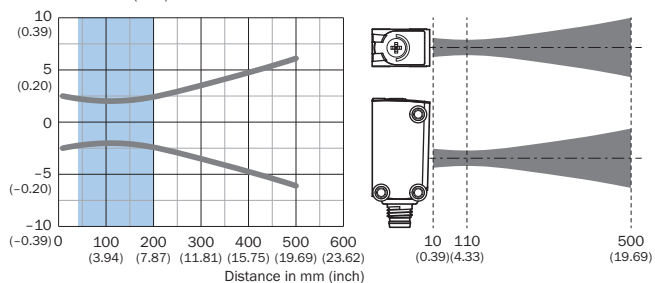

Recommended sensing range for the best performance

Mode 1, 3, 4, 5

Dimensions in mm (inch)

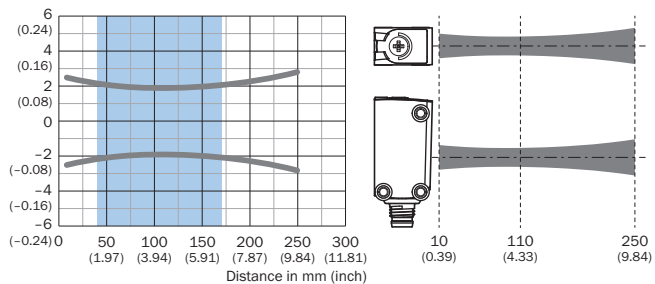

Recommended sensing range for the best performance

Sensing range diagram

Mode 2

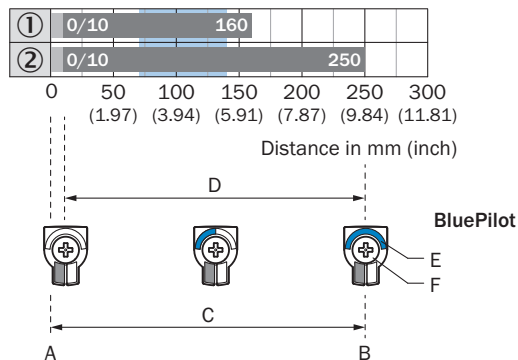

Recommended sensing range for the best performance

1	Black background, 6% remission factor
2	White background, 90% remission factor
A	Sensing range min. in mm
B	Sensing range max. in mm
C	Field of view
D	Adjustable switching threshold for foreground suppression
E	Sensing range indicator
F	Teach-Turn adjustment

Mode 1 and 6 combined

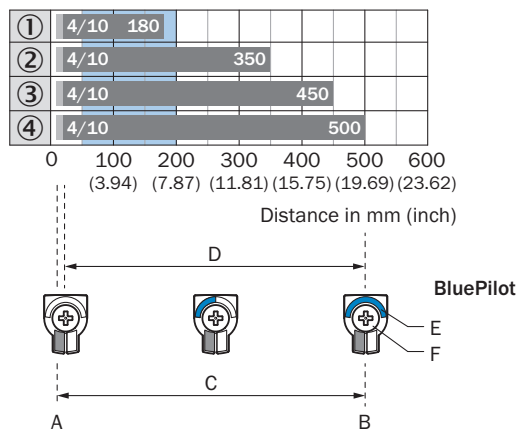

Recommended sensing range for the best performance

1	Ultra-black object, 1% remission factor
2	Black object, 6% remission factor
3	Gray object, 18% remission factor
4	White object, 90% remission factor
A	Sensing range min. in mm
B	Sensing range max. in mm

C	Field of view
D	Adjustable switching threshold for background suppression
E	Sensing range indicator
F	Teach-Turn adjustment

Mode 1, 3, 4, 5

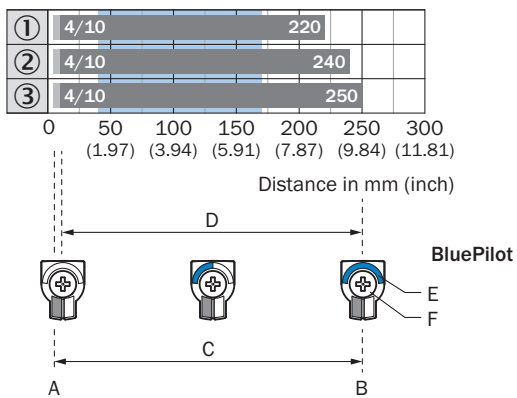

Recommended sensing range for the best performance

1	Black object, 6% remission factor
2	Gray object, 18% remission factor
3	White object, 90% remission factor
A	Sensing range min. in mm
B	Sensing range max. in mm
C	Field of view
D	Adjustable switching threshold for background suppression
E	Sensing range indicator
F	Teach-Turn adjustment

Dimensional drawing (Dimensions in mm (inch))

Dimensional drawing, sensor

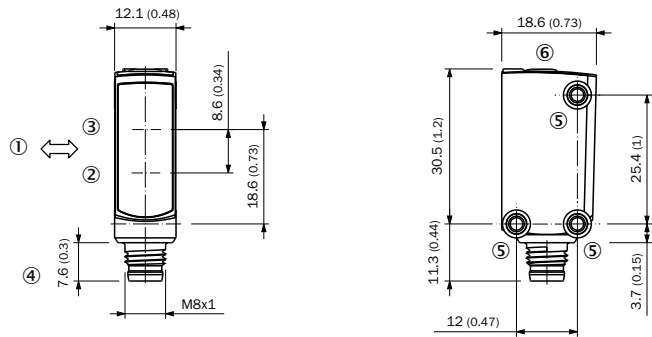

- ① Standard direction of the material being detected
- ② Center of optical axis, sender
- ③ Center of optical axis, receiver
- ④ Connection
- ⑤ M3 mounting hole
- ⑥ Display and adjustment elements

SICK AT A GLANCE

SICK is one of the leading manufacturers of intelligent sensors and sensor solutions for industrial applications. A unique range of products and services creates the perfect basis for controlling processes securely and efficiently, protecting individuals from accidents and preventing damage to the environment.

We have extensive experience in a wide range of industries and understand their processes and requirements. With intelligent sensors, we can deliver exactly what our customers need. In application centers in Europe, Asia and North America, system solutions are tested and optimized in accordance with customer specifications. All this makes us a reliable supplier and development partner.

Comprehensive services complete our offering: SICK LifeTime Services provide support throughout the machine life cycle and ensure safety and productivity.

For us, that is “Sensor Intelligence.”

WORLDWIDE PRESENCE:

Contacts and other locations –www.sick.com