



WTS26P-24161120A00

W26

COMPACT PHOTOELECTRIC SENSORS

SICK
Sensor Intelligence.



Illustration may differ

Ordering information

Type	Part no.
WTS26P-24161120A00	1218668

Other models and accessories → www.sick.com/W26



Detailed technical data

Features

Functional principle	Photoelectric proximity sensor
Functional principle detail	Background suppression, TwinEye technology
Sensing range	
Sensing range min.	10 mm
Sensing range max.	1,000 mm
Adjustable switching threshold for background suppression	150 mm ... 1,000 mm
Reference object	Object with 90% remission factor (complies with standard white according to DIN 5033)
Minimum distance between set sensing range and background (black 6% / white 90%)	25 mm, at a distance of 500 mm
Recommended sensing range for the best performance	200 mm ... 500 mm
Emitted beam	
Light source	PinPoint LED
Type of light	Visible red light
Shape of light spot	Point-shaped
Light spot size (distance)	Ø 10 mm (550 mm)
Maximum dispersion of the emitted beam around the standardized transmission axis (squint angle)	< +/- 1.0° (at Ta = +23 °C)

Key LED figures	
Normative reference	EN 62471:2008-09 IEC 62471:2006, modified
LED risk group marking	Free group
Wave length	635 nm
Average service life	100,000 h at T _a = +25 °C
Adjustment	
Teach-Turn adjustment	BluePilot: For setting the sensing range
IO-Link	For configuring the sensor parameters and Smart Task functions
Indication	
LED blue	BluePilot: sensing range indicator
LED green	Operating indicator Static on: power on Flashing: IO-Link mode
LED yellow	Status of received light beam Static on: object present Static off: object not present
Special applications	
Detecting uneven, shiny objects, Detecting objects wrapped in film	

Safety-related parameters

MTTF_D	413 years
DC_{avg}	0%
T_M (mission time)	20 years (EN ISO 13849, rate of use: 60 %)

Communication interface

IO-Link	✓, V1.1
Data transmission rate	COM2 (38,4 kBaud)
Cycle time	2.3 ms
Process data length	16 Bit
Process data structure	Bit 0 = switching signal Q _{L1} Bit 1 = switching signal Q _{L2} Bit 2 ... 15 = empty
VendorID	26
DeviceID HEX	0x80017C
DeviceID DEC	8388988
Compatible master port type	A
SIO mode support	Yes

Electrical data

Supply voltage U_B	10 V DC ... 30 V DC ¹⁾
Ripple	≤ 5 V _{pp}
Usage category	DC-12 (According to EN 60947-5-2) DC-13 (According to EN 60947-5-2)
Current consumption	≤ 30 mA, without load. At U _B = 24 V
Protection class	III

- 1) Limit values.
- 2) Signal transit time with resistive load in switching mode.
- 3) With light/dark ratio 1:1.
- 4) This switching output must not be connected to another output.

Digital output	
Number	2 (Complementary)
Type	Push-pull: PNP/NPN
Switching mode	Light/dark switching
Signal voltage PNP HIGH/LOW	Approx. $U_B - 2.5 \text{ V} / 0 \text{ V}$
Signal voltage NPN HIGH/LOW	Approx. $U_B / < 2.5 \text{ V}$
Output current I_{max}	$\leq 100 \text{ mA}$
Circuit protection outputs	Reverse polarity protected Overcurrent and short-circuit protected
Response time	$\leq 1.4 \text{ ms}^{2)}$
Repeatability (response time)	$750 \mu\text{s}$
Switching frequency	$350 \text{ Hz}^{3)}$
Pin/Wire assignment	
Function of pin 4/black (BK)	Digital output, light switching, object present → output Q_{L1} HIGH; IO-Link communication C ⁴⁾
Function of pin 4/black (BK) – detail	The pin 4 function of the sensor can be configured, Additional possible settings via IO-Link
Function of pin 2/white (WH)	Digital output, dark switching, object present → output \bar{Q}_{L1} LOW ⁴⁾
Function of pin 2/white (WH) – detail	The pin 2 function of the sensor can be configured, Additional possible settings via IO-Link

¹⁾ Limit values.

²⁾ Signal transit time with resistive load in switching mode.

³⁾ With light/dark ratio 1:1.

⁴⁾ This switching output must not be connected to another output.

Mechanical data

Housing	Rectangular
Dimensions (W x H x D)	24.6 mm x 82.5 mm x 53.3 mm
Connection	Male connector M12, 4-pin
Material	
Housing	Plastic, VISTAL®
Front screen	Plastic, PMMA
Male connector	Plastic, VISTAL®
Weight	Approx. 80 g
Maximum tightening torque of the fixing screws	1.3 Nm

Ambient data

Enclosure rating	IP66 (EN 60529) IP67 (EN 60529) IP69 (EN 60529) ¹⁾
Ambient operating temperature	-40 °C ... +60 °C
Ambient temperature, storage	-40 °C ... +75 °C
Shock resistance	50 g, 11 ms (25 positive and 25 negative shocks per axis, for X, Y, Z axes, 150 shocks in total (EN60068-2-27)) 50 g, 6 ms (5,000 positive and 5,000 negative shocks per axis, for X, Y, Z axes, 30,000 shocks in total (EN60068-2-27))

¹⁾ Replaces IP69K with ISO 20653: 2013-03.

Vibration resistance	10 Hz ... 2,000 Hz (Amplitude 0.5 mm / 10 g, 20 sweeps per axis, for X, Y, Z axes, 1 octave/min, (EN60068-2-6))
Air humidity	35 % ... 95 %, relative humidity (no condensation)
Electromagnetic compatibility (EMC)	EN 60947-5-2
Resistance to cleaning agent	ECOLAB
UL File No.	NRKH.E181493 & NRKH7.E181493

¹⁾ Replaces IP69K with ISO 20653: 2013-03.

Smart Task

Smart Task name	Base logics
Logic function	Direct AND OR Window Hysteresis
Timer function	Deactivated Switch-on delay Off delay ON and OFF delay Impulse (one shot)
Inverter	Yes
Switching frequency	SIO Logic: 300 Hz ¹⁾ IOL: 280 Hz ²⁾
Response time	SIO Logic: 1.65 ms ¹⁾ IOL: 1.75 ms ²⁾
Repeatability	SIO Logic: 800 µs ¹⁾ IOL: 900 µs ²⁾
Switching signal	
Switching signal Q _{L1}	Switching output
Switching signal \bar{Q}_{L1}	Switching output

¹⁾ Use of Smart Task functions without IO-Link communication (SIO mode).

²⁾ Use of Smart Task functions with IO-Link communication function.

Diagnosis

Device status	Yes
Quality of teach	Yes

Classifications

ECLASS 5.0	27270904
ECLASS 5.1.4	27270904
ECLASS 6.0	27270904
ECLASS 6.2	27270904
ECLASS 7.0	27270904
ECLASS 8.0	27270904
ECLASS 8.1	27270904
ECLASS 9.0	27270904
ECLASS 10.0	27270904
ECLASS 11.0	27270904

ECLASS 12.0	27270903
ETIM 5.0	EC002719
ETIM 6.0	EC002719
ETIM 7.0	EC002719
ETIM 8.0	EC002719
UNSPSC 16.0901	39121528

Dimensional drawing (Dimensions in mm (inch))

Dimensional drawing, sensor

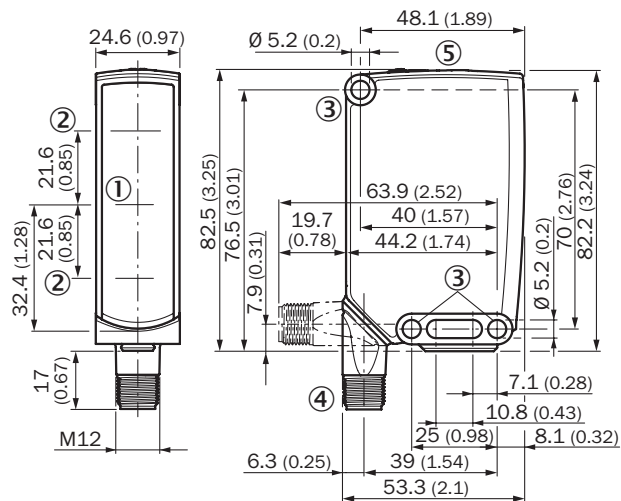

- ① Center of optical axis, sender
- ② Center of optical axis, receiver
- ③ Mounting hole, Ø 5.2 mm
- ④ Connection
- ⑤ Display and adjustment elements

Adjustments

Display and adjustment elements

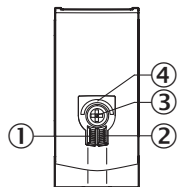

- ① LED indicator green
- ② LED indicator yellow
- ③ Teach-Turn adjustment
- ④ LED blue

Connection type

M12 male connector, 4-pin

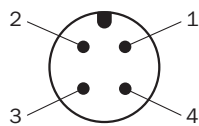

Connection diagram

Cd-390

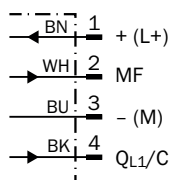

Truth table

Push-pull: PNP/NPN – dark switching \bar{Q}

	Dark switching Q (normally closed (upper switch), normally open (lower switch))	
	Object not present → Output HIGH	Object present → Output LOW
Light receive	✗	✓
Light receive indicator	✗	☉
Load resistance to L+	✗	⚠
Load resistance to M	⚠	✗

Push-pull: PNP/NPN - light switching Q

	Light switching Q (normally open (upper switch), normally closed (lower switch))	
	Object not present → Output LOW	Object present → Output HIGH
Light receive	✗	✓
Light receive indicator	✗	☉
Load resistance to L+	⚠	✗
Load resistance to M	✗	⚠

Characteristic curve

Minimum distance in mm (y) between the set sensing range (x) and white background (90 % remission)

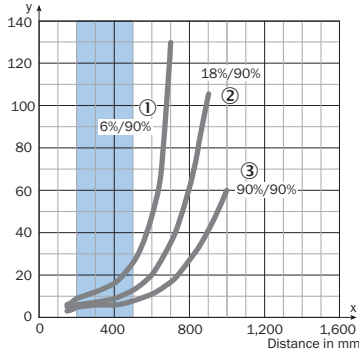

Example:
 Safe suppression of the background

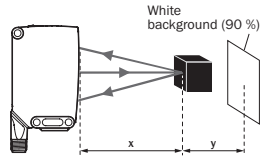

Black object (6 % remission)
 Set sensing range x = 500 mm
 Needed minimum distance to white background y = 25 mm

Recommended sensing range for the best performance

- ① Sensing range on black, 6% remission factor
- ② Sensing range on gray, 18% remission factor
- ③ Sensing range on white, 90% remission factor

Light spot size

WTS26P-xxxxx1xx

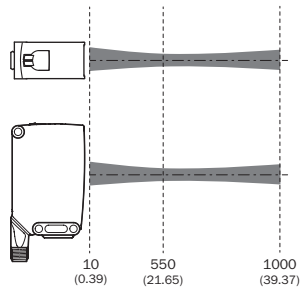
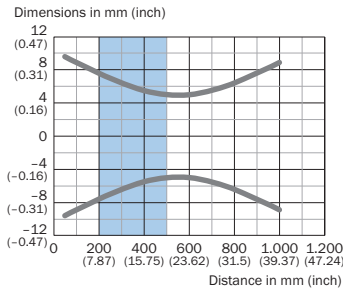

Recommended sensing range for the best performance

Sensing range diagram

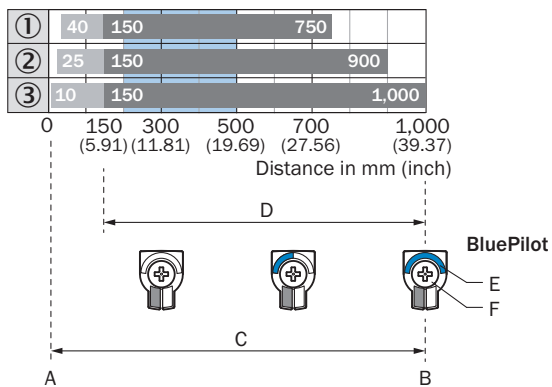



Recommended sensing range for the best performance

1	Black object, 6% remission factor
2	Gray object, 18% remission factor
3	White object, 90% remission factor
A	Sensing range min. in mm
B	Sensing range max. in mm
C	Field of view
D	Adjustable switching threshold for background suppression
E	Sensing range indicator
F	Teach-Turn adjustment

Recommended accessories

Other models and accessories → www.sick.com/W26

	Brief description	Type	Part no.
Universal bar clamp systems			
	Plate N12 for universal clamp. For mounting PL30A, P250 reflectors, W27 and WTR2 sensors., Zinc plated steel (sheet), Zinc die cast (clamping bracket), Universal clamp (2022726), mounting hardware	BEF-KHS-N12	2071950
Others			
	<ul style="list-style-type: none"> • Connection type head A: Male connector, M12, 4-pin, straight, A-coded • Description: Unshielded • Connection systems: Screw-type terminals • Permitted cross-section: ≤ 0.75 mm² 	STE-1204-G	6009932
	<ul style="list-style-type: none"> • Connection type head A: Female connector, M12, 4-pin, straight, A-coded • Connection type head B: Flying leads • Signal type: Sensor/actuator cable • Cable: 5 m, 4-wire, PVC • Description: Sensor/actuator cable, unshielded • Application: Zones with chemicals 	YF2A14-050VB3XLEAX	2096235

Recommended services

Additional services → www.sick.com/W26

	Type	Part no.
Function Block Factory		
<ul style="list-style-type: none"> • Description: The Function Block Factory supports common programmable logic controllers (PLCs) from various manufacturers, such as Siemens, Beckhoff, Rockwell Automation and B&R. More information on the FBF can be found <a _blank"="" href="https://fbf.cloud.sick.com target=">here. • Note: You can configure your function block at <a _blank"="" href="https://fbf.cloud.sick.com target=">Function Block Factory. As a login please use your SICK ID. 	Function Block Factory	On request

SICK AT A GLANCE

SICK is one of the leading manufacturers of intelligent sensors and sensor solutions for industrial applications. A unique range of products and services creates the perfect basis for controlling processes securely and efficiently, protecting individuals from accidents and preventing damage to the environment.

We have extensive experience in a wide range of industries and understand their processes and requirements. With intelligent sensors, we can deliver exactly what our customers need. In application centers in Europe, Asia and North America, system solutions are tested and optimized in accordance with customer specifications. All this makes us a reliable supplier and development partner.

Comprehensive services complete our offering: SICK LifeTime Services provide support throughout the machine life cycle and ensure safety and productivity.

For us, that is “Sensor Intelligence.”

WORLDWIDE PRESENCE:

Contacts and other locations –www.sick.com