

WTT12LC-B2563S21

WTT12 PowerProx

TIME-OF-FLIGHT SENSORS

SICK
Sensor Intelligence.

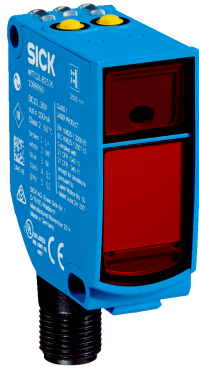

Illustration may differ



Ordering information

Type	Part no.
WTT12LC-B2563S21	1108976

Other models and accessories → www.sick.com/WTT12_PowerProx

Detailed technical data

Features

Functional principle	Photoelectric proximity sensor
Functional principle detail	Background suppression, Optical time-of-flight
Housing design (light emission)	Rectangular
Sensing range max.	50 mm ... 3,800 mm ¹⁾
Sensing range	100 mm ... 3,800 mm ^{1) 2)}
Distance value	
Measuring range	50 mm ... 3,800 mm ¹⁾
Resolution	1 mm
Repeatability	1,1 mm ... 3,0 mm ^{3) 4) 5)}
Accuracy	Typ. ± 15 mm
Type of light	Visible red light
Light source	Laser ⁶⁾
Light spot size (distance)	Ø 18 mm (3,800 mm)
Wave length	658 nm
Laser class	1 (IEC 60825-1 / CDRH 21 CFR 1040.10 & 1040.11)
Adjustment	Single teach-in button (2 x), IO-Link
Safety-related parameters	

¹⁾ Object with 6 ... 90% remission (based on standard white, DIN 5033).

²⁾ Adjustable.

³⁾ Equivalent to 1 σ .

⁴⁾ See characteristic curves repeatability.

⁵⁾ 6% ... 90% remission factor.

⁶⁾ Average service life: 100,000 h at T_U = +25 °C.

MTTF _D	138 years
DC _{avg}	0 %

- 1) Object with 6 ... 90% remission (based on standard white, DIN 5033).
- 2) Adjustable.
- 3) Equivalent to 1 σ .
- 4) See characteristic curves repeatability.
- 5) 6% ... 90% remission factor.
- 6) Average service life: 100,000 h at T_U = +25 °C.

Interfaces

Communication interface	IO-Link V1.1
Communication Interface detail	COM2 (38,4 kBaud)
Cycle time	5 ms
Process data length	32 Bit
Process data structure	Bit 0 = switching signal Q ₀₁ Bit 1 = switching signal Q ₀₂ Bit 2 ... 8 = BDC 2 ... 8 Bit 9 ... 15 = empty Bit 16 ... 31 = distance value
Additional features	8 switching points for distance to object, of which 2 can be inverted, 1 switching point as switching window or configurable with hysteresis., multifunctional input: sender off, external teach, inactive
VendorID	26
DeviceID HEX	0x800269
DeviceID DEC	8389225

Electronics

Supply voltage U_B	10 V DC ... 30 V DC ^{1) 2)}
Ripple	< 5 V _{pp} ³⁾
Current consumption	70 mA ⁴⁾
Switching output	Push-pull: PNP/NPN ⁵⁾
Number of switching outputs	2 (Q ₁ , Q ₂) ⁵⁾
Switching mode	Light switching ⁵⁾
Output current I_{max}	≤ 100 mA
Response time	≤ 5 ms ⁶⁾
Switching frequency	100 Hz ⁷⁾
Analog output	-

- 1) Limit values. Operated in short-circuit protected network: max. 8 A.
- 2) V_S min at IO-Link operation = 18 V.
- 3) May not fall below or exceed U_V tolerances.
- 4) Without load. At V_S = 24 V.
- 5) Q₁, Q₂ = 2 switching thresholds, light switching.
- 6) Signal transit time with resistive load.
- 7) With light/dark ratio 1:1.
- 8) A = V_S connections reverse-polarity protected.
- 9) B = inputs and output reverse-polarity protected.
- 10) C = interference suppression.
- 11) Below T_U = -10 °C a warm-up time is necessary.

Input	MF _{in} = multifunctional input programmable
Circuit protection	A ⁸⁾ B ⁹⁾ C ¹⁰⁾
Protection class	III
Enclosure rating	IP67
Warm-up time	< 15 min ¹¹⁾
Initialization time	< 300 ms

¹⁾ Limit values. Operated in short-circuit protected network: max. 8 A.

²⁾ V_S min at IO-Link operation = 18 V.

³⁾ May not fall below or exceed U_y tolerances.

⁴⁾ Without load. At V_S = 24 V.

⁵⁾ Q1, Q2 = 2 switching thresholds, light switching.

⁶⁾ Signal transit time with resistive load.

⁷⁾ With light/dark ratio 1:1.

⁸⁾ A = V_S connections reverse-polarity protected.

⁹⁾ B = inputs and output reverse-polarity protected.

¹⁰⁾ C = interference suppression.

¹¹⁾ Below T_u = -10 °C a warm-up time is necessary.

Mechanics

Dimensions (W x H x D)	20 mm x 49.6 mm x 44.2 mm
Housing material	Plastic, VISTAL®
Optics material	Plastic, PMMA
Weight	48 g
Connection type	Male connector M12, 5-pin

Ambient data

Ambient operating temperature	-35 °C ... +50 °C ¹⁾
Ambient temperature, storage	-40 °C ... +70 °C

¹⁾ As of T_a = 45 °C, a max.load current I_{max} = 50 mA is permitted.

Classifications

ECLASS 5.0	27270904
ECLASS 5.1.4	27270904
ECLASS 6.0	27270904
ECLASS 6.2	27270904
ECLASS 7.0	27270904
ECLASS 8.0	27270904
ECLASS 8.1	27270904
ECLASS 9.0	27270904
ECLASS 10.0	27270904
ECLASS 11.0	27270904
ECLASS 12.0	27270903
ETIM 5.0	EC002719
ETIM 6.0	EC002719

ETIM 7.0	EC002719
ETIM 8.0	EC002719
UNSPSC 16.0901	39121528

Dimensional drawing (Dimensions in mm (inch))

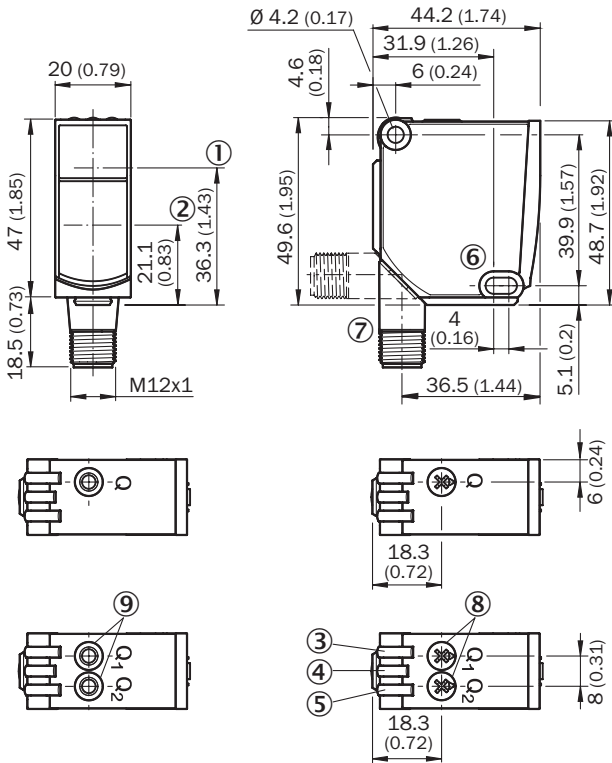

- ① Optical axis, sender
- ② Optical axis, receiver
- ③ LED indicator yellow: Status of received light beam
- ④ LED indicator green: power on
- ⑤ LED indicator yellow: Status of received light beam
- ⑥ Mounting hole, $\varnothing 4.2$ mm
- ⑦ Connection
- ⑧ Potentiometer
- ⑨ Single teach-in button

Connection diagram

Cd-460

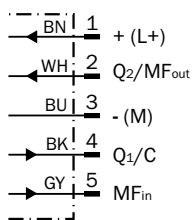

Characteristic curve

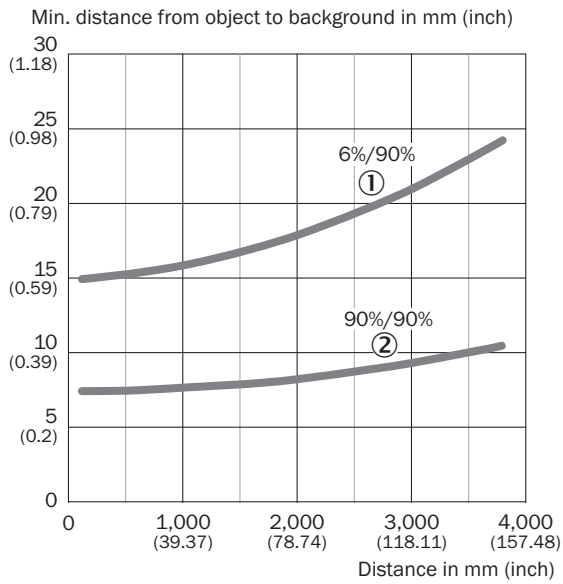

- ① Sensing range on black, 6% remission factor
- ② Sensing range on white, 90% remission factor

Light spot size

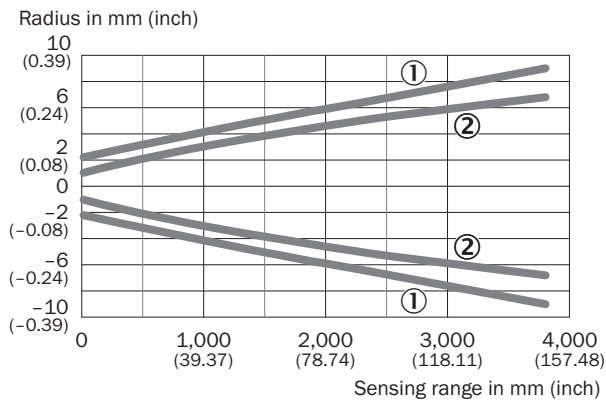

- ① Light spot horizontal
- ② Light spot vertical

Repeatability



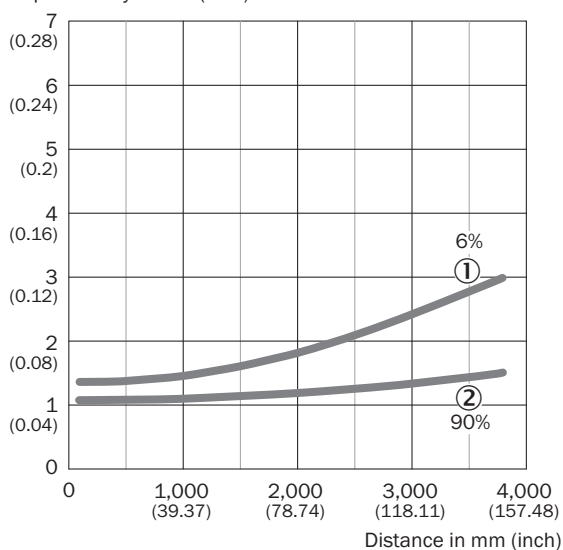

Repeatability in mm (inch)

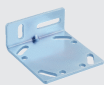

- ① 6 % remission, on black
- ② 90 % remission, on white

Recommended accessories

Other models and accessories → www.sick.com/WTT12_PowerProx

	Brief description	Type	Part no.
Mounting brackets and plates			
	<ul style="list-style-type: none"> Description: Mounting brackets Suitable for: PowerProx 	BEF-WTT12L	2078538
Others			
	<ul style="list-style-type: none"> Connection type head A: Female connector, M12, 5-pin, straight, A-coded Connection type head B: Flying leads Signal type: Sensor/actuator cable Cable: 2 m, 5-wire, PVC Description: Sensor/actuator cable, unshielded Application: Zones with chemicals, Uncontaminated zones 	YF2A15-020VB5XLEAX	2096239
	<ul style="list-style-type: none"> Connection type head A: Male connector, M12, 5-pin, straight, A-coded Description: Unshielded, Head A: male connector, M12, 5-pin, straight, unshielded, for cable diameter 4 mm ... 6 mm Head B: - Connection systems: Screw-type terminals Permitted cross-section: ≤ 0.75 mm² Note: For field bus technology 	STE-1205-G	6022083
	<ul style="list-style-type: none"> Connection type head A: Female connector, M12, 5-pin, straight, A-coded Connection type head B: Flying leads Signal type: Sensor/actuator cable Cable: 5 m, 5-wire, PVC Description: Sensor/actuator cable, unshielded Application: Zones with chemicals, Uncontaminated zones 	YF2A15-050VB5XLEAX	2096240

SICK AT A GLANCE

SICK is one of the leading manufacturers of intelligent sensors and sensor solutions for industrial applications. A unique range of products and services creates the perfect basis for controlling processes securely and efficiently, protecting individuals from accidents and preventing damage to the environment.

We have extensive experience in a wide range of industries and understand their processes and requirements. With intelligent sensors, we can deliver exactly what our customers need. In application centers in Europe, Asia and North America, system solutions are tested and optimized in accordance with customer specifications. All this makes us a reliable supplier and development partner.

Comprehensive services complete our offering: SICK LifeTime Services provide support throughout the machine life cycle and ensure safety and productivity.

For us, that is “Sensor Intelligence.”

WORLDWIDE PRESENCE:

Contacts and other locations –www.sick.com