



# WTT12L-B1546

WTT12 PowerProx

TIME-OF-FLIGHT SENSORS

**SICK**  
Sensor Intelligence.



Illustration may differ



### Ordering information

Type	Part no.
WTT12L-B1546	1072616

Other models and accessories → [www.sick.com/WTT12\\_PowerProx](http://www.sick.com/WTT12_PowerProx)

### Detailed technical data

#### Features

<b>Functional principle</b>	Photoelectric proximity sensor
<b>Functional principle detail</b>	Background suppression, Optical time-of-flight
<b>Housing design (light emission)</b>	Rectangular
<b>Sensing range max.</b>	50 mm ... 1,800 mm <sup>1)</sup>
<b>Sensing range</b>	100 mm ... 1,800 mm <sup>2) 3)</sup>
<b>Type of light</b>	Visible red light
<b>Light source</b>	Laser <sup>4)</sup>
<b>Light spot size (distance)</b>	Ø 12 mm (1,800 mm)
<b>Wave length</b>	658 nm
<b>Laser class</b>	1 (IEC 60825-1 / CDRH 21 CFR 1040.10 & 1040.11)
<b>Adjustment</b>	Potentiometer, 4 turns (2 x)
<b>Safety-related parameters</b>	
	MTTF <sub>D</sub> 133 years
	DC <sub>avg</sub> 0 %
	T <sub>M</sub> (mission time) 20 years

<sup>1)</sup> Object with 6 ... 90% remission (based on standard white, DIN 5033).

<sup>2)</sup> Adjustable.

<sup>3)</sup> Object with 90% remission (based on standard white, DIN 5033).

<sup>4)</sup> Average service life: 100,000 h at T<sub>U</sub> = +25 °C.

## Electronics

<b>Supply voltage <math>U_B</math></b>	10 V DC ... 30 V DC <sup>1)</sup>
<b>Ripple</b>	< 5 V <sub>pp</sub> <sup>2)</sup>
<b>Current consumption</b>	70 mA <sup>3)</sup>
<b>Switching output</b>	Push-pull: PNP/NPN <sup>4)</sup>
<b>Number of switching outputs</b>	2 (Q <sub>1</sub> , Q <sub>2</sub> ) <sup>4)</sup>
<b>Switching mode</b>	Light switching <sup>4)</sup>
<b>Output current <math>I_{max}</math></b>	≤ 100 mA
<b>Response time</b>	≤ 16.7 ms <sup>5)</sup>
<b>Switching frequency</b>	30 Hz <sup>6)</sup>
<b>Analog output</b>	-
<b>Input</b>	Sender off
<b>Circuit protection</b>	A <sup>7)</sup> B <sup>8)</sup> C <sup>9)</sup>
<b>Protection class</b>	III
<b>Enclosure rating</b>	IP67
<b>Warm-up time</b>	< 15 min <sup>10)</sup>
<b>Initialization time</b>	< 300 ms

<sup>1)</sup> Limit values. Operated in short-circuit protected network: max. 8 A.

<sup>2)</sup> May not fall below or exceed  $U_V$  tolerances.

<sup>3)</sup> Without load. At  $V_S = 24$  V.

<sup>4)</sup> Q<sub>1</sub>, Q<sub>2</sub> = 2 switching thresholds, light switching.

<sup>5)</sup> Signal transit time with resistive load.

<sup>6)</sup> With light/dark ratio 1:1.

<sup>7)</sup> A =  $V_S$  connections reverse-polarity protected.

<sup>8)</sup> B = inputs and output reverse-polarity protected.

<sup>9)</sup> C = interference suppression.

<sup>10)</sup> Below  $T_U = -10$  °C a warm-up time is necessary.

## Mechanics

<b>Dimensions (W x H x D)</b>	20 mm x 49.6 mm x 44.2 mm
<b>Housing material</b>	Plastic, VISTAL®
<b>Optics material</b>	Plastic, PMMA
<b>Weight</b>	111 g
<b>Connection type</b>	Cable, 5-wire, 2 m
<b>Connection type Detail</b>	
Conductor cross section	0.14 mm <sup>2</sup>
Cable material	Plastic, PVC

## Ambient data

<b>Ambient operating temperature</b>	-35 °C ... +50 °C <sup>1)</sup>
<b>Ambient temperature, storage</b>	-40 °C ... +70 °C

<sup>1)</sup> As of  $T_a = 45$  °C, a max.load current  $I_{max} = 50$  mA is permitted.

### Classifications

<b>ECLASS 5.0</b>	27270904
<b>ECLASS 5.1.4</b>	27270904
<b>ECLASS 6.0</b>	27270904
<b>ECLASS 6.2</b>	27270904
<b>ECLASS 7.0</b>	27270904
<b>ECLASS 8.0</b>	27270904
<b>ECLASS 8.1</b>	27270904
<b>ECLASS 9.0</b>	27270904
<b>ECLASS 10.0</b>	27270904
<b>ECLASS 11.0</b>	27270904
<b>ECLASS 12.0</b>	27270903
<b>ETIM 5.0</b>	EC002719
<b>ETIM 6.0</b>	EC002719
<b>ETIM 7.0</b>	EC002719
<b>ETIM 8.0</b>	EC002719
<b>UNSPSC 16.0901</b>	39121528

Dimensional drawing (Dimensions in mm (inch))

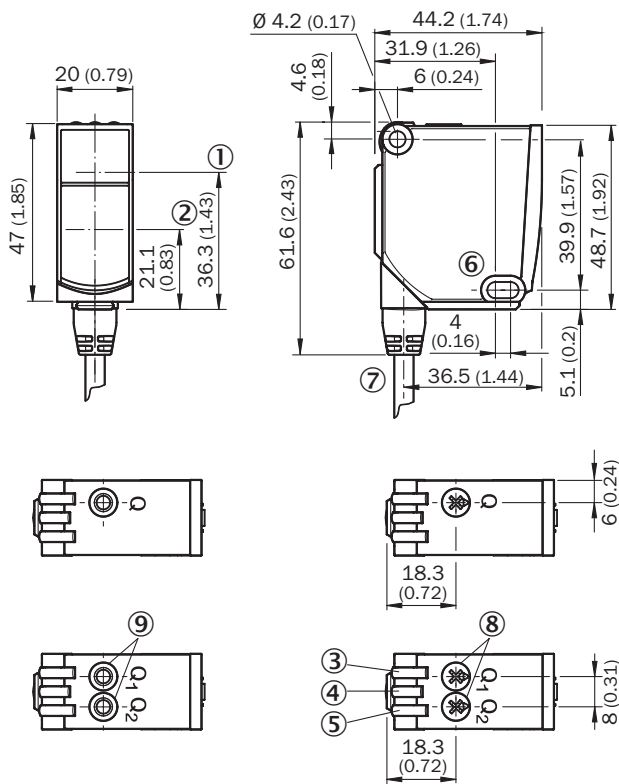

- ① Optical axis, sender
- ② Optical axis, receiver
- ③ LED indicator yellow: Status of received light beam
- ④ LED indicator green: power on
- ⑤ LED indicator yellow: Status of received light beam
- ⑥ Mounting hole,  $\varnothing 4.2$  mm
- ⑦ Connection
- ⑧ Potentiometer
- ⑨ Single teach-in button

Connection diagram

Cd-285

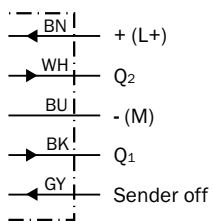

### Characteristic curve

Min. distance from object to background in mm (inch)

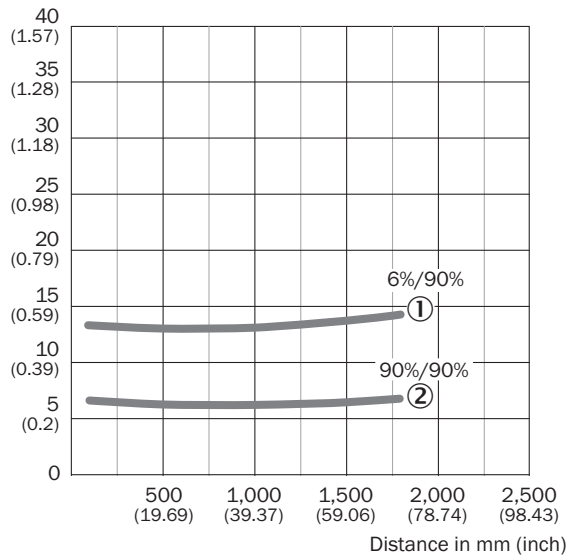

- ① Sensing range on black, 6% remission factor
- ② Sensing range on white, 90% remission factor

### Light spot size

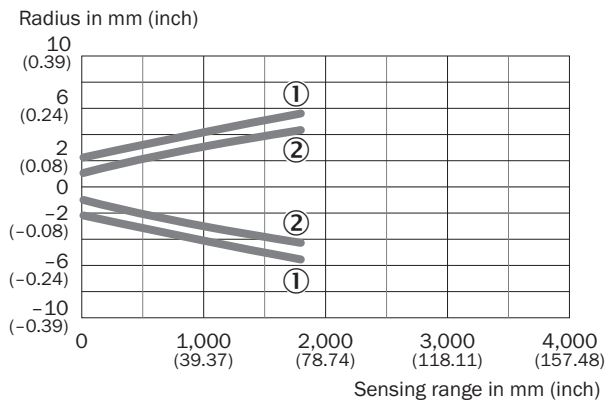

- ① Light spot horizontal
- ② Light spot vertical

### Repeatability

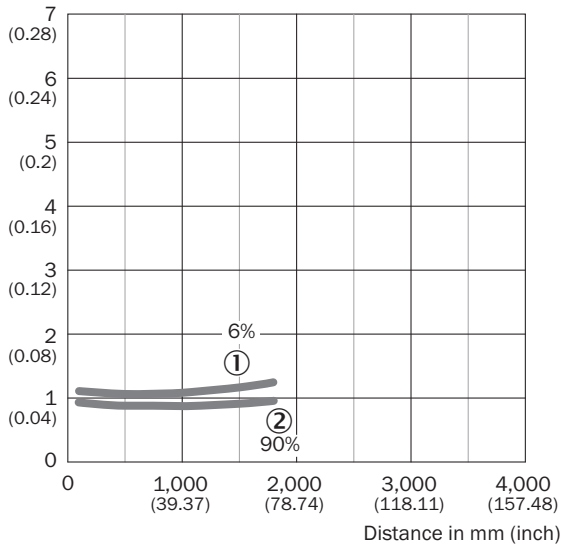

Repeatability in mm (inch)



- ① 6 % remission, on black
- ② 90 % remission, on white

### Recommended accessories

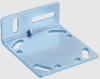
Other models and accessories → [www.sick.com/WTT12\\_PowerProx](http://www.sick.com/WTT12_PowerProx)

	Brief description	Type	Part no.
<b>Mounting brackets and plates</b>			
	<ul style="list-style-type: none"> <li>• <b>Description:</b> Mounting brackets</li> <li>• <b>Suitable for:</b> PowerProx</li> </ul>	BEF-WTT12L	2078538
<b>Others</b>			
	<ul style="list-style-type: none"> <li>• <b>Connection type head A:</b> Male connector, M12, 5-pin, straight, A-coded</li> <li>• <b>Description:</b> Unshielded, Head A: male connector, M12, 5-pin, straight, unshielded, for cable diameter 4 mm ... 6 mm Head B: -</li> <li>• <b>Connection systems:</b> Screw-type terminals</li> <li>• <b>Permitted cross-section:</b> ≤ 0.75 mm<sup>2</sup></li> <li>• <b>Note:</b> For field bus technology</li> </ul>	STE-1205-G	6022083

## SICK AT A GLANCE

SICK is one of the leading manufacturers of intelligent sensors and sensor solutions for industrial applications. A unique range of products and services creates the perfect basis for controlling processes securely and efficiently, protecting individuals from accidents and preventing damage to the environment.

We have extensive experience in a wide range of industries and understand their processes and requirements. With intelligent sensors, we can deliver exactly what our customers need. In application centers in Europe, Asia and North America, system solutions are tested and optimized in accordance with customer specifications. All this makes us a reliable supplier and development partner.

Comprehensive services complete our offering: SICK LifeTime Services provide support throughout the machine life cycle and ensure safety and productivity.

For us, that is “Sensor Intelligence.”

## WORLDWIDE PRESENCE:

Contacts and other locations –[www.sick.com](http://www.sick.com)