



# WTT280L-2N2531

WTT280 PowerProx

TIME-OF-FLIGHT SENSORS

**SICK**  
Sensor Intelligence.



### Ordering information

Type	Part no.
WTT280L-2N2531	6048063

**Included in delivery:** BEF-W280 (1)

Other models and accessories → [www.sick.com/WTT280\\_PowerProx](http://www.sick.com/WTT280_PowerProx)

Illustration may differ



### Detailed technical data

#### Features

<b>Functional principle</b>	Photoelectric proximity sensor
<b>Functional principle detail</b>	Background suppression, Optical time-of-flight
<b>Housing design (light emission)</b>	Rectangular
<b>Sensing range max.</b>	200 mm ... 4,000 mm <sup>1)</sup> 200 mm ... 3,000 mm <sup>2)</sup>
<b>Sensing range</b>	200 mm ... 4,000 mm <sup>1) 3)</sup> 200 mm ... 3,000 mm <sup>2) 3)</sup>
<b>Type of light</b>	Visible red light
<b>Light source</b>	Laser <sup>4)</sup>
<b>Light spot size (distance)</b>	Ø 12 mm (3 m)
<b>Laser class</b>	1 (EN 60825-1:2014, IEC 60825-1:2014)
<b>Adjustment</b>	Potentiometer (1 x)
<b>Special applications</b>	Detecting small objects
<b>Items supplied</b>	Mounting bracket BEF-W280
<b>Safety-related parameters</b>	
	MTTF <sub>D</sub> 202 years
	DC <sub>avg</sub> 0 %

<sup>1)</sup> Object with 90% remission (based on standard white, DIN 5033).

<sup>2)</sup> Objects to be sensed with 6 % reflectivity (based on black).

<sup>3)</sup> Einstellbar.

<sup>4)</sup> Average service life: 100,000 h at T<sub>U</sub> = +25 °C.

## Electronics

<b>Supply voltage <math>U_B</math></b>	10 V DC ... 30 V DC <sup>1)</sup>
<b>Ripple</b>	< 3 V <sub>pp</sub>
<b>Current consumption</b>	70 mA <sup>2)</sup>
<b>Switching output</b>	NPN
<b>Number of switching outputs</b>	1 (Q <sub>1</sub> ) <sup>3)</sup>
<b>Switching mode</b>	Light/dark switching
<b>Switching mode selector</b>	Selectable via light/dark rotary switch
<b>Output current <math>I_{max}</math></b>	≤ 100 mA
<b>Response time</b>	≤ 0.5 ms <sup>4)</sup>
<b>Switching frequency</b>	1,000 Hz <sup>5)</sup>
<b>Analog output</b>	-
<b>Input</b>	Sender off
<b>Circuit protection</b>	A <sup>6)</sup> B <sup>7)</sup> C <sup>8)</sup> D <sup>9)</sup>
<b>Protection class</b>	III
<b>Enclosure rating</b>	IP67

<sup>1)</sup> Limit values. Operated in short-circuit protected network: max. 8 A.

<sup>2)</sup> Without load.

<sup>3)</sup> Q<sub>1</sub> = 1 switching threshold, light/dark switching selectable via light/dark selector.

<sup>4)</sup> Signal transit time with resistive load.

<sup>5)</sup> With light/dark ratio 1:1.

<sup>6)</sup> A = V<sub>S</sub> connections reverse-polarity protected.

<sup>7)</sup> B = output reverse-polarity protected.

<sup>8)</sup> C = interference suppression.

<sup>9)</sup> D = outputs overcurrent and short-circuit protected.

## Mechanics

<b>Dimensions (W x H x D)</b>	23.5 mm x 76 mm x 55.8 mm
<b>Housing material</b>	Plastic, ABS
<b>Optics material</b>	Plastic, PMMA
<b>Weight</b>	120 g
<b>Connection type</b>	Male connector M12, 5-pin

## Ambient data

<b>Ambient operating temperature</b>	-10 °C ... +50 °C
<b>Ambient temperature, storage</b>	-40 °C ... +70 °C
<b>Electromagnetic compatibility (EMC)</b>	EN 60947-5-2

## Classifications

<b>ECLASS 5.0</b>	27270904
<b>ECLASS 5.1.4</b>	27270904
<b>ECLASS 6.0</b>	27270904
<b>ECLASS 6.2</b>	27270904

<b>ECLASS 7.0</b>	27270904
<b>ECLASS 8.0</b>	27270904
<b>ECLASS 8.1</b>	27270904
<b>ECLASS 9.0</b>	27270904
<b>ECLASS 10.0</b>	27270904
<b>ECLASS 11.0</b>	27270904
<b>ECLASS 12.0</b>	27270903
<b>ETIM 5.0</b>	EC002719
<b>ETIM 6.0</b>	EC002719
<b>ETIM 7.0</b>	EC002719
<b>ETIM 8.0</b>	EC002719
<b>UNSPSC 16.0901</b>	39121528

### Dimensional drawing (Dimensions in mm (inch))

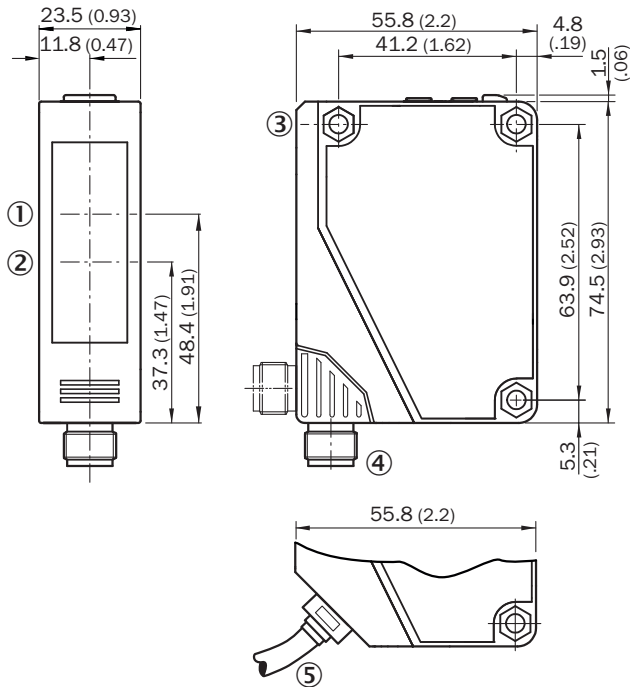

- ① Center of optical axis, receiver
- ② Center of optical axis, sender
- ③ Mounting hole, Ø 4.3 mm
- ④ M12 plug connector, 5-pin, can be rotated through 90°
- ⑤ Cable, 2 m, 5-wire, Ø 3.8 mm

### Connection type

WTT280L-2x25xx WLT280L-2x25xx

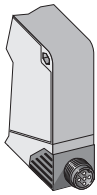

### Connection diagram

Cd-210

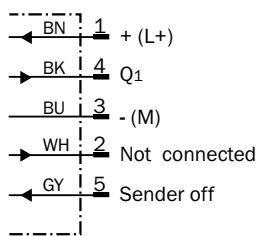

### Adjustment possible

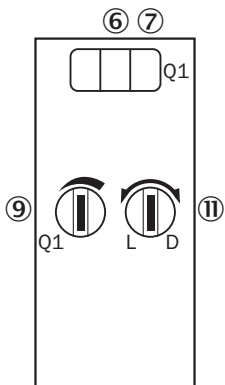

WTT280L-2xxxx1



- ⑥ LED indicator green: Stability indicator
- ⑦ LED indicator yellow: Status of received light beam
- ⑨ Sensing range adjustment: potentiometer
- ⑪ Light/dark selector

### Recommended accessories

Other models and accessories → [www.sick.com/WTT280\\_PowerProx](http://www.sick.com/WTT280_PowerProx)

	Brief description	Type	Part no.
Mounting brackets and plates			
	Mounting bracket, Stainless steel V2A (1.4301), 2 screws, 2 nuts, 2 circlips, 2 washers for mounting the sensor	BEF-W280	5313885
Others			
	<ul style="list-style-type: none"> <li>• <b>Connection type head A:</b> Male connector, M12, 5-pin, straight, A-coded</li> <li>• <b>Description:</b> Unshielded, Head A: male connector, M12, 5-pin, straight, unshielded, for cable diameter 4 mm ... 6 mm Head B: -</li> <li>• <b>Connection systems:</b> Screw-type terminals</li> <li>• <b>Permitted cross-section:</b> ≤ 0.75 mm<sup>2</sup></li> <li>• <b>Note:</b> For field bus technology</li> </ul>	STE-1205-G	6022083
	<ul style="list-style-type: none"> <li>• <b>Connection type head A:</b> Female connector, M12, 5-pin, straight, A-coded</li> <li>• <b>Connection type head B:</b> Flying leads</li> <li>• <b>Signal type:</b> Sensor/actuator cable</li> <li>• <b>Cable:</b> 5 m, 5-wire, PVC</li> <li>• <b>Description:</b> Sensor/actuator cable, unshielded</li> <li>• <b>Application:</b> Zones with chemicals</li> </ul>	YF2A15-050VB5XLEAX	2096240

## SICK AT A GLANCE

SICK is one of the leading manufacturers of intelligent sensors and sensor solutions for industrial applications. A unique range of products and services creates the perfect basis for controlling processes securely and efficiently, protecting individuals from accidents and preventing damage to the environment.

We have extensive experience in a wide range of industries and understand their processes and requirements. With intelligent sensors, we can deliver exactly what our customers need. In application centers in Europe, Asia and North America, system solutions are tested and optimized in accordance with customer specifications. All this makes us a reliable supplier and development partner.

Comprehensive services complete our offering: SICK LifeTime Services provide support throughout the machine life cycle and ensure safety and productivity.

For us, that is “Sensor Intelligence.”

## WORLDWIDE PRESENCE:

Contacts and other locations –[www.sick.com](http://www.sick.com)