



WTT2SLC-2P3292B02

WTT2 PowerProx

TIME-OF-FLIGHT SENSORS

SICK
Sensor Intelligence.



Illustration may differ



Ordering information

Type	Part no.
WTT2SLC-2P3292B02	1101641

Other models and accessories → www.sick.com/WTT2_PowerProx

Detailed technical data

Features

Functional principle	Photoelectric proximity sensor
Functional principle detail	Background suppression, Optical time-of-flight
Housing design (light emission)	Rectangular
Sensing range max.	50 mm ... 800 mm ¹⁾
Sensing range	50 mm ... 800 mm ¹⁾
Distance value	
Repeatability	2 mm ... 5 mm ²⁾
Accuracy	± 20 mm
Type of light	Infrared light
Light source	Laser ³⁾
Light spot size (distance)	Ø 10 mm (300 mm)
Wave length	940 nm
Laser class	1
Adjustment	Single teach-in button, IO-Link ⁴⁾
Pin 2 configuration	External input, Teach-in input, Sender off input, Detection output, logic output
Special applications	Detecting small objects
Safety-related parameters	
MTTF _D	925 years

¹⁾ Object with 6 ... 90% remission (based on standard white, DIN 5033).

²⁾ Equivalent to 1 σ .

³⁾ Average service life: 50,000 h at T_U = +25 °C.

⁴⁾ Teach-Offset 15 mm.

DC_{avg} 0 %

- 1) Object with 6 ... 90% remission (based on standard white, DIN 5033).
- 2) Equivalent to 1 σ .
- 3) Average service life: 50,000 h at T_J = +25 °C.
- 4) Teach-Offset 15 mm.

Interfaces

Communication interface	IO-Link V1.1
Communication Interface detail	COM2 (38,4 kBaud)
Cycle time	5 ms
Process data length	4 Byte
Process data structure	Bit 0 = switching signal Q _{L1} Bit 1 = switching signal Q _{L2} Bit 2 = detection signal Q _{int.1} Bit 3 = detection signal Q _{int.2} Bit 4 ... 15 = empty Bit 16 ... 31 = distance value
VendorID	26
DeviceID HEX	0x8001B8
DeviceID DEC	8389048

Electronics

Supply voltage U_B	10 V DC ... 30 V DC ¹⁾
Ripple	< 5 V _{pp} ²⁾
Current consumption	20 mA ³⁾
Switching output	PNP
Switching mode	Light/dark switching
Output current I_{max.}	≤ 50 mA
Response time	Typ. 95 ms ⁴⁾
Switching frequency	5 Hz ⁵⁾
Analog output	-
Input	MF _{in} = multifunctional input programmable
Circuit protection	A ⁶⁾ B ⁷⁾ D ⁸⁾
Protection class	III
Enclosure rating	IP67

1) Limit values. Operated in short-circuit protected network: max. 8 A.

2) May not fall below or exceed U_y tolerances.

3) Without load.

4) Jitter +/- 20 ms.

5) With light/dark ratio 1:1.

6) A = V_S connections reverse-polarity protected.

7) B = output reverse-polarity protected.

8) D = outputs overcurrent and short-circuit protected.

Mechanics

Dimensions (W x H x D)	7.7 mm x 27.5 mm x 13.5 mm
-------------------------------	----------------------------

Housing material	Plastic, MABS, ABS
Optics material	Plastic, PMMA
Connection type	Cable with M8 male connector, 4-pin, 90 mm
Connection type Detail	
Cable diameter	Ø 3 mm
Cable material	Plastic, PVC

Ambient data

Ambient operating temperature	-25 °C ... +50 °C
Ambient temperature, storage	-40 °C ... +75 °C

Smart Task

Smart Task name	Base logics
Logic function	Direct AND OR WINDOW Hysteresis
Timer function	Deactivated Switch-on delay Off delay ON and OFF delay Impulse (one shot)
Inverter	Yes
Switching frequency	SIO Direct: 5 Hz ¹⁾ SIO Logic: 5 Hz ²⁾ IOL: 5 Hz ³⁾
Response time	SIO Direct: typ. 90 ms ¹⁾ SIO Logic: typ. 90 ms ²⁾ IOL: typ. 95 ms ³⁾
Repeatability	^{2) 3)}

¹⁾ SIO Direct: sensor operation in standard I/O mode without IO-Link communication and without using internal sensor logic or time parameters (set to "direct"/"deactivated").

²⁾ SIO Logic: Sensor operation in standard I/O mode without IO-Link communication. Sensor-internal logic or timing parameters plus Automation Functions used.

³⁾ IOL: Sensor operation with full IO-Link communication and usage of logic, timing and Automation Function parameters.

Classifications

ECLASS 5.0	27270904
ECLASS 5.1.4	27270904
ECLASS 6.0	27270904
ECLASS 6.2	27270904
ECLASS 7.0	27270904
ECLASS 8.0	27270904
ECLASS 8.1	27270904
ECLASS 9.0	27270904
ECLASS 10.0	27270904
ECLASS 11.0	27270904
ECLASS 12.0	27270903
ETIM 5.0	EC002719

ETIM 6.0	EC002719
ETIM 7.0	EC002719
ETIM 8.0	EC002719
UNSPSC 16.0901	39121528

Dimensional drawing (Dimensions in mm (inch))

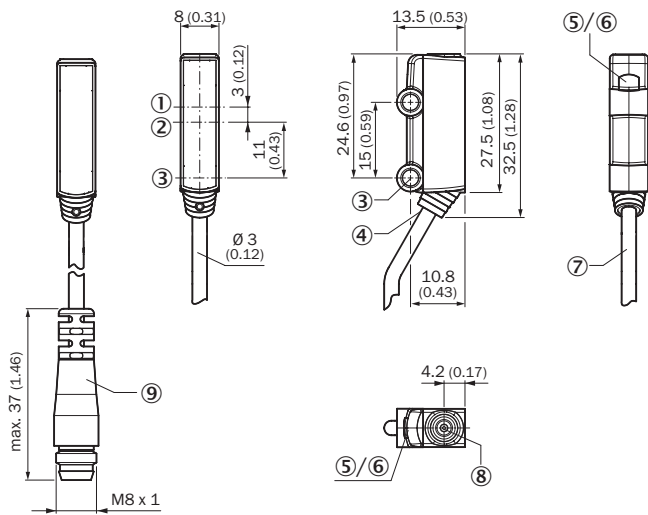

- ① Optical axis, receiver
- ② Optical axis, sender
- ③ Mounting hole, \varnothing 3.2 mm
- ④ Connection
- ⑤ LED indicator green: Supply voltage active
- ⑥ LED indicator yellow: Status of received light beam
- ⑦ Cable
- ⑧ Single teach-in button
- ⑨ Cable with connector M8

Connection diagram

Cd-367

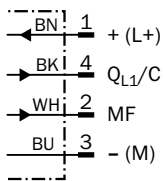

Light spot size

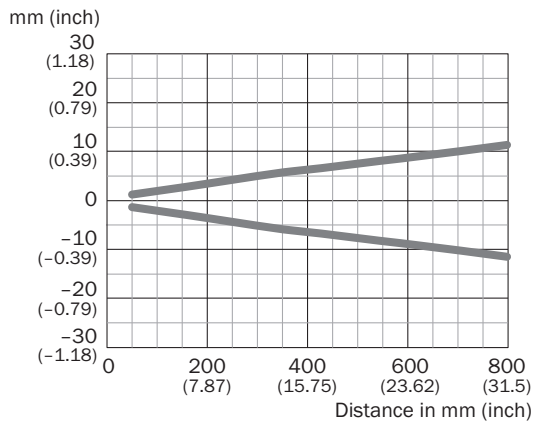

Sensing distance

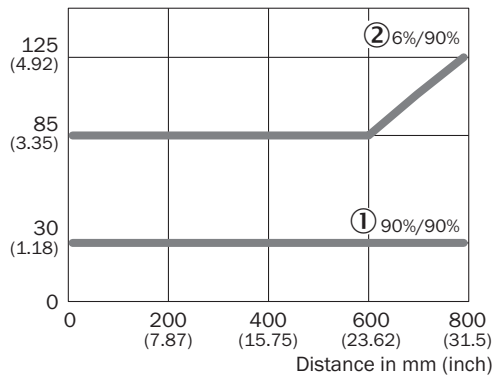

Min. distance from object to background in mm (inch)



- ① Sensing range on white, 90% remission factor
- ② Sensing range on black, 6% remission factor

Recommended accessories

Other models and accessories → www.sick.com/WTT2_PowerProx

	Brief description	Type	Part no.
Mounting brackets and plates			
	Mounting bracket for wall mounting, steel, zinc coated, without mounting hardware	BEF-W2S-B	4034749
Others			
	<ul style="list-style-type: none"> • Connection type head A: Female connector, M8, 4-pin, straight, A-coded • Connection type head B: Flying leads • Signal type: Sensor/actuator cable • Cable: 5 m, 4-wire, PVC • Description: Sensor/actuator cable, unshielded • Application: Zones with chemicals 	YF8U14-050VA3XLEAX	2095889

	Brief description	Type	Part no.
	<ul style="list-style-type: none"> • Connection type head A: Male connector, M8, 4-pin, straight, A-coded • Description: Unshielded • Connection systems: Screw-type terminals • Permitted cross-section: 0.14 mm² ... 0.5 mm² 	STE-0804-G	6037323

Recommended services

Additional services → www.sick.com/WTT2_PowerProx

	Type	Part no.
Function Block Factory		
<ul style="list-style-type: none"> • Description: The Function Block Factory supports common programmable logic controllers (PLCs) from various manufacturers, such as Siemens, Beckhoff, Rockwell Automation and B&R. More information on the FBF can be found <a _blank"="" href="https://fbf.cloud.sick.com target=">here. • Note: You can configure your function block at <a _blank"="" href="https://fbf.cloud.sick.com target=">Function Block Factory. As a login please use your SICK ID. 	Function Block Factory	On request

SICK AT A GLANCE

SICK is one of the leading manufacturers of intelligent sensors and sensor solutions for industrial applications. A unique range of products and services creates the perfect basis for controlling processes securely and efficiently, protecting individuals from accidents and preventing damage to the environment.

We have extensive experience in a wide range of industries and understand their processes and requirements. With intelligent sensors, we can deliver exactly what our customers need. In application centers in Europe, Asia and North America, system solutions are tested and optimized in accordance with customer specifications. All this makes us a reliable supplier and development partner.

Comprehensive services complete our offering: SICK LifeTime Services provide support throughout the machine life cycle and ensure safety and productivity.

For us, that is “Sensor Intelligence.”

WORLDWIDE PRESENCE:

Contacts and other locations –www.sick.com