



# WTT2SL-2F3092S08

WTT2 PowerProx

TIME-OF-FLIGHT SENSORS

**SICK**  
Sensor Intelligence.



### Ordering information

Type	Part no.
WTT2SL-2F3092S08	1112130

Other models and accessories → [www.sick.com/WTT2\\_PowerProx](http://www.sick.com/WTT2_PowerProx)

Illustration may differ

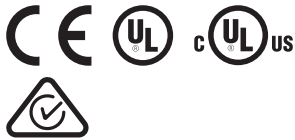

### Detailed technical data

#### Features

<b>Functional principle</b>	Photoelectric proximity sensor
<b>Functional principle detail</b>	Background suppression, Optical time-of-flight
<b>Housing design (light emission)</b>	Rectangular
<b>Sensing range max.</b>	50 mm ... 800 mm <sup>1)</sup>
<b>Sensing range</b>	50 mm ... 800 mm <sup>1)</sup>
<b>Type of light</b>	Infrared light
<b>Light source</b>	Laser <sup>2)</sup>
<b>Light spot size (distance)</b>	Ø 10 mm (300 mm)
<b>Wave length</b>	940 nm
<b>Laser class</b>	1
<b>Adjustment</b>	Single teach-in button <sup>3)</sup>
<b>Special applications</b>	Detecting small objects
<b>Safety-related parameters</b>	
	MTTF <sub>D</sub> 925 years
	DC <sub>avg</sub> 0 %

<sup>1)</sup> Object with 6 ... 90% remission (based on standard white, DIN 5033).

<sup>2)</sup> Average service life: 50,000 h at T<sub>U</sub> = +25 °C.

<sup>3)</sup> Teach-Offset 15 mm.

## Electronics

<b>Supply voltage <math>U_B</math></b>	10 V DC ... 30 V DC <sup>1)</sup>
<b>Ripple</b>	< 5 V <sub>pp</sub> <sup>2)</sup>
<b>Current consumption</b>	20 mA <sup>3)</sup>
<b>Switching output</b>	PNP <sup>4)</sup>
<b>Switching mode</b>	Dark switching
<b>Output current <math>I_{max}</math></b>	≤ 50 mA
<b>Response time</b>	Typ. 90 ms <sup>5)</sup>
<b>Switching frequency</b>	5 Hz <sup>6)</sup>
<b>Analog output</b>	-
<b>Circuit protection</b>	A <sup>7)</sup> B <sup>8)</sup> D <sup>9)</sup>
<b>Protection class</b>	III
<b>Enclosure rating</b>	IP67

1) Limit values. Operated in short-circuit protected network: max. 8 A.

2) May not fall below or exceed  $U_V$  tolerances.

3) Without load.

4) Off-state current  $I_R$  ≤ 0,6 mA.

5) Jitter +/- 20 ms.

6) With light/dark ratio 1:1.

7) A = V<sub>S</sub> connections reverse-polarity protected.

8) B = output reverse-polarity protected.

9) D = outputs overcurrent and short-circuit protected.

## Mechanics

<b>Dimensions (W x H x D)</b>	7.7 mm x 27.5 mm x 13.5 mm
<b>Housing material</b>	Plastic, MABS, ABS
<b>Optics material</b>	Plastic, PMMA
<b>Connection type</b>	Cable with JST-connector, 550 mm
<b>Connection type Detail</b>	
	Cable diameter Ø 3 mm
	Cable material Plastic, PVC

## Ambient data

<b>Ambient operating temperature</b>	-25 °C ... +50 °C
<b>Ambient temperature, storage</b>	-40 °C ... +75 °C

## Classifications

<b>ECLASS 5.0</b>	27270904
<b>ECLASS 5.1.4</b>	27270904
<b>ECLASS 6.0</b>	27270904
<b>ECLASS 6.2</b>	27270904
<b>ECLASS 7.0</b>	27270904
<b>ECLASS 8.0</b>	27270904

<b>ECLASS 8.1</b>	27270904
<b>ECLASS 9.0</b>	27270904
<b>ECLASS 10.0</b>	27270904
<b>ECLASS 11.0</b>	27270904
<b>ECLASS 12.0</b>	27270903
<b>ETIM 5.0</b>	EC002719
<b>ETIM 6.0</b>	EC002719
<b>ETIM 7.0</b>	EC002719
<b>ETIM 8.0</b>	EC002719
<b>UNSPSC 16.0901</b>	39121528

### Dimensional drawing (Dimensions in mm (inch))

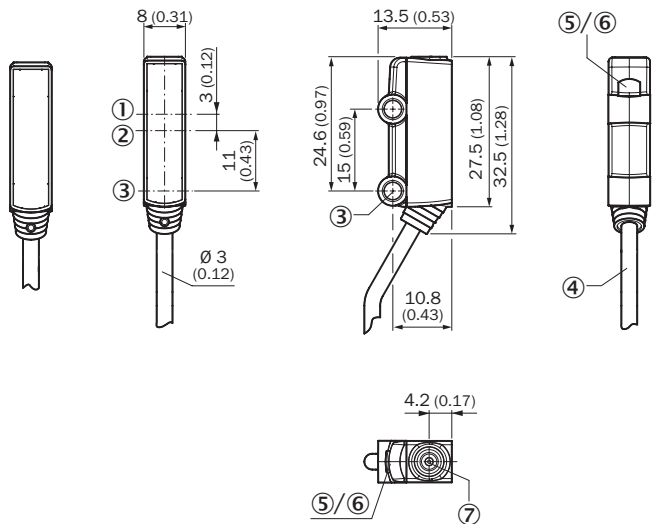

- ① Optical axis, receiver
- ② Optical axis, sender
- ③ Mounting hole,  $\varnothing$  3.2 mm
- ④ Cable with connector, JST, EHR-3
- ⑤ LED indicator green: Supply voltage active
- ⑥ LED indicator yellow: Status of received light beam
- ⑦ Single teach-in button

### Connection diagram

Cd-469

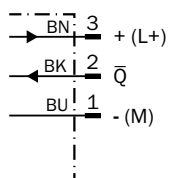

### Light spot size

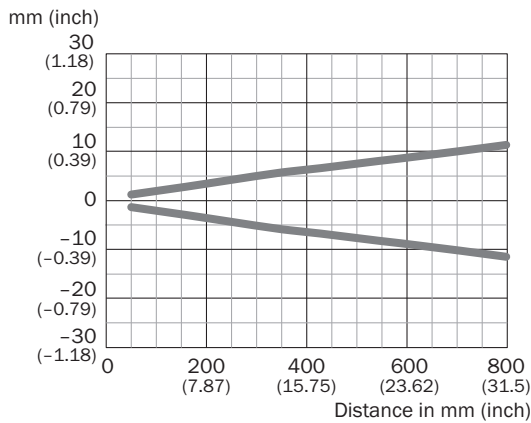

### Sensing distance

Min. distance from object to background in mm (inch)

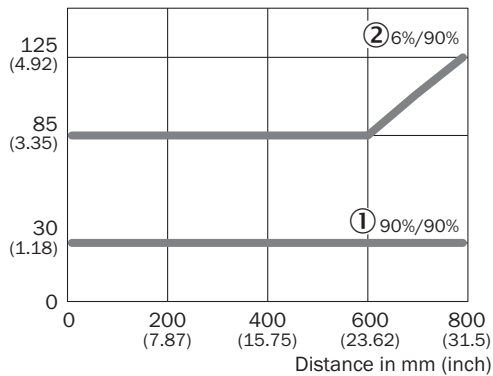

- ① Sensing range on white, 90% remission factor
- ② Sensing range on black, 6% remission factor

### Recommended accessories

Other models and accessories → [www.sick.com/WTT2\\_PowerProx](http://www.sick.com/WTT2_PowerProx)

	Brief description	Type	Part no.
Mounting brackets and plates			
	Mounting bracket for wall mounting, steel, zinc coated, without mounting hardware	BEF-W2S-B	4034749

## SICK AT A GLANCE

SICK is one of the leading manufacturers of intelligent sensors and sensor solutions for industrial applications. A unique range of products and services creates the perfect basis for controlling processes securely and efficiently, protecting individuals from accidents and preventing damage to the environment.

We have extensive experience in a wide range of industries and understand their processes and requirements. With intelligent sensors, we can deliver exactly what our customers need. In application centers in Europe, Asia and North America, system solutions are tested and optimized in accordance with customer specifications. All this makes us a reliable supplier and development partner.

Comprehensive services complete our offering: SICK LifeTime Services provide support throughout the machine life cycle and ensure safety and productivity.

For us, that is “Sensor Intelligence.”

## WORLDWIDE PRESENCE:

Contacts and other locations –[www.sick.com](http://www.sick.com)