



WTT2SL-2P3492S01

WTT2 PowerProx

TIME-OF-FLIGHT SENSORS

SICK
Sensor Intelligence.



Ordering information

Type	Part no.
WTT2SL-2P3492S01	1088393

Other models and accessories → www.sick.com/WTT2_PowerProx

Illustration may differ

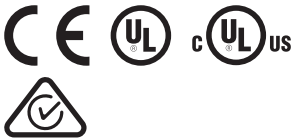

Detailed technical data

Features

Functional principle	Photoelectric proximity sensor
Functional principle detail	Background suppression, Optical time-of-flight
Housing design (light emission)	Rectangular
Sensing range max.	50 mm ... 800 mm ¹⁾
Sensing range	50 mm ... 800 mm ¹⁾
Type of light	Infrared light
Light source	Laser ²⁾
Light spot size (distance)	Ø 10 mm (300 mm)
Wave length	940 nm
Laser class	1
Adjustment	Single teach-in button ³⁾
Special applications	Detecting small objects
Safety-related parameters	
	MTTF _D 925 years
	DC _{avg} 0 %

¹⁾ Object with 6 ... 90% remission (based on standard white, DIN 5033).

²⁾ Average service life: 50,000 h at T_U = +25 °C.

³⁾ Teach-Offset 15 mm.

Electronics

Supply voltage U_B	10 V DC ... 30 V DC ¹⁾
Ripple	< 5 V _{pp} ²⁾
Current consumption	20 mA ³⁾
Switching output	PNP
Switching mode	Light/dark switching
Output current I_{max}	≤ 50 mA
Response time	Typ. 90 ms ⁴⁾
Switching frequency	5 Hz ⁵⁾
Analog output	-
Circuit protection	A ⁶⁾ B ⁷⁾ D ⁸⁾
Protection class	III
Enclosure rating	IP67

¹⁾ Limit values. Operated in short-circuit protected network: max. 8 A.

²⁾ May not fall below or exceed U_y tolerances.

³⁾ Without load.

⁴⁾ Jitter +/- 20 ms.

⁵⁾ With light/dark ratio 1:1.

⁶⁾ A = V_S connections reverse-polarity protected.

⁷⁾ B = output reverse-polarity protected.

⁸⁾ D = outputs overcurrent and short-circuit protected.

Mechanics

Dimensions (W x H x D)	7.7 mm x 27.5 mm x 13.5 mm
Housing material	Plastic, MABS, ABS
Optics material	Plastic, PMMA
Connection type	Cable with M12 male connector, 4-pin, 300 mm
Connection type Detail	
Cable diameter	Ø 3 mm
Cable material	Plastic, PVC

Ambient data

Ambient operating temperature	-25 °C ... +50 °C
Ambient temperature, storage	-40 °C ... +75 °C

Classifications

ECLASS 5.0	27270904
ECLASS 5.1.4	27270904
ECLASS 6.0	27270904
ECLASS 6.2	27270904
ECLASS 7.0	27270904
ECLASS 8.0	27270904
ECLASS 8.1	27270904

ECLASS 9.0	27270904
ECLASS 10.0	27270904
ECLASS 11.0	27270904
ECLASS 12.0	27270903
ETIM 5.0	EC002719
ETIM 6.0	EC002719
ETIM 7.0	EC002719
ETIM 8.0	EC002719
UNSPSC 16.0901	39121528

Dimensional drawing (Dimensions in mm (inch))

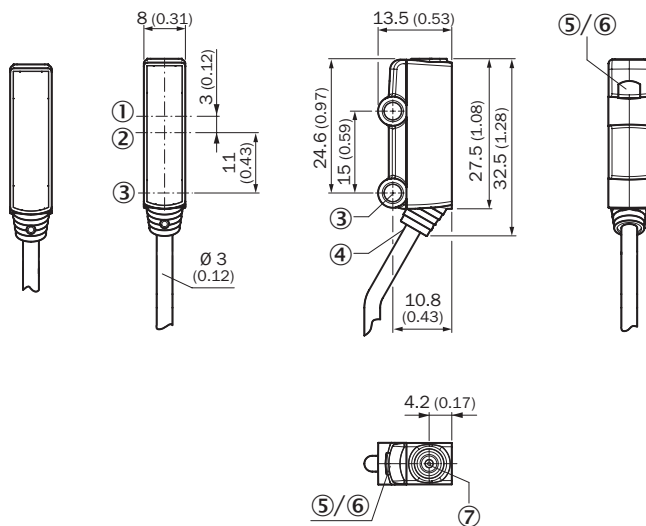

- ① Optical axis, receiver
- ② Optical axis, sender
- ③ Mounting hole, $\varnothing 3.2$ mm
- ④ Connection
- ⑤ LED indicator green: Supply voltage active
- ⑥ LED indicator yellow: Status of received light beam
- ⑦ Single teach-in button

Connection diagram

Cd-083

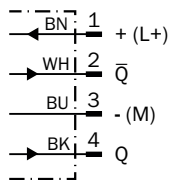

Light spot size

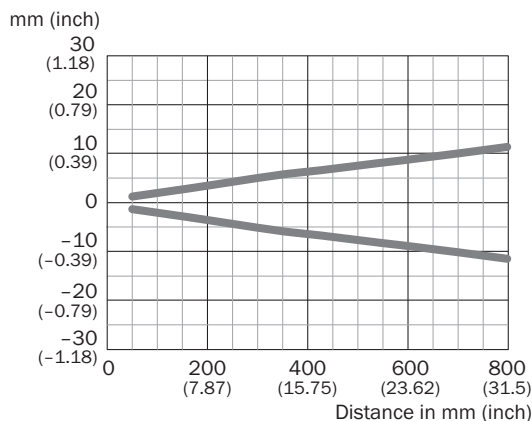

Sensing distance

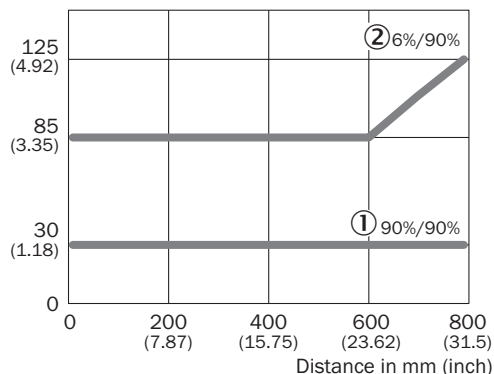

Min. distance from object to background in mm (inch)



- ① Sensing range on white, 90% remission factor
- ② Sensing range on black, 6% remission factor

Recommended accessories

Other models and accessories → www.sick.com/WTT2_PowerProx

	Brief description	Type	Part no.
Mounting brackets and plates			
	Mounting bracket for wall mounting, steel, zinc coated, without mounting hardware	BEF-W2S-B	4034749
Others			
	<ul style="list-style-type: none"> • Connection type head A: Female connector, M12, 4-pin, straight, A-coded • Connection type head B: Flying leads • Signal type: Sensor/actuator cable • Cable: 5 m, 4-wire, PVC • Description: Sensor/actuator cable, unshielded • Application: Zones with chemicals 	YF2A14-050VB3XLEAX	2096235

	Brief description	Type	Part no.
	<ul style="list-style-type: none">• Connection type head A: Male connector, M12, 4-pin, straight, A-coded• Description: Unshielded• Connection systems: Screw-type terminals• Permitted cross-section: ≤ 0.75 mm²	STE-1204-G	6009932

SICK AT A GLANCE

SICK is one of the leading manufacturers of intelligent sensors and sensor solutions for industrial applications. A unique range of products and services creates the perfect basis for controlling processes securely and efficiently, protecting individuals from accidents and preventing damage to the environment.

We have extensive experience in a wide range of industries and understand their processes and requirements. With intelligent sensors, we can deliver exactly what our customers need. In application centers in Europe, Asia and North America, system solutions are tested and optimized in accordance with customer specifications. All this makes us a reliable supplier and development partner.

Comprehensive services complete our offering: SICK LifeTime Services provide support throughout the machine life cycle and ensure safety and productivity.

For us, that is “Sensor Intelligence.”

WORLDWIDE PRESENCE:

Contacts and other locations –www.sick.com