



WTT4SLC-3B2262B01

WTT4 PowerProx

TIME-OF-FLIGHT SENSORS

SICK
Sensor Intelligence.



Illustration may differ



Ordering information

Type	Part no.
WTT4SLC-3B2262B01	1106949

Other models and accessories → www.sick.com/WTT4_PowerProx

Detailed technical data

Features

Functional principle	Photoelectric proximity sensor
Functional principle detail	Background suppression, Optical time-of-flight
Housing design (light emission)	Rectangular
Sensing range max.	50 mm ... 1,300 mm ¹⁾
Sensing range	100 mm ... 1,300 mm ²⁾
Distance value	
Measuring range	90 mm ... 1,300 mm ¹⁾
Resolution	1 mm
Repeatability	4,5 mm ... 11 mm ^{3) 4) 5)}
Accuracy	± 35 mm
Distance value output	Via IO-Link
Update rate of the distance value	0.8 ms
Type of light	Visible red light
Light source	Laser ⁶⁾
Light spot size (distance)	Ø 4.4 mm (1,300 mm)
Wave length	658 nm
Laser class	1 (IEC 60825-1 / CDRH 21 CFR 1040.10 & 1040.11)

¹⁾ Object with 6 ... 90% remission (based on standard white, DIN 5033).

²⁾ Adjustable.

³⁾ Equivalent to 1 σ .

⁴⁾ See characteristic curves repeatability.

⁵⁾ 6% ... 90% remission factor.

⁶⁾ Average service life: 50,000 h at T_U = +25 °C.

Adjustment	Single teach-in button, IO-Link
Pin 2 configuration	External input, Teach-in input, Sender off input, Detection output, logic output
Safety-related parameters	
	MTTF _D 256 years
	DC _{avg} 0 %
	T _M (mission time) 20 years

1) Object with 6 ... 90% remission (based on standard white, DIN 5033).

2) Adjustable.

3) Equivalent to 1 σ .

4) See characteristic curves repeatability.

5) 6% ... 90% remission factor.

6) Average service life: 50,000 h at T_U = +25 °C.

Interfaces

Communication interface	IO-Link V1.1
Communication Interface detail	COM3 (230,4 kBaud)
Cycle time	0.8 ms
Process data length	4 Byte
Process data structure	Bit 0 = switching signal Q _{L1} Bit 1 = switching signal Q _{L2} Bit 2 = detection signal Q _{int.1} Bit 3 = detection signal Q _{int.2} Bit 4 = detection signal Q _{int.3} Bit 5 = detection signal Q _{int.4} Bit 6 = detection signal Q _{int.5} Bit 7 = detection signal Q _{int.6} Bit 8 = detection signal Q _{int.7} Bit 9 = detection signal Q _{int.8} Bit 10 ... 15 = empty Bit 16 ... 31 = distance value
VendorID	26
DeviceID HEX	0x800264
DeviceID DEC	8389220

Electronics

Supply voltage U_B	10 V DC ... 30 V DC ¹⁾
Ripple	< 5 V _{pp} ²⁾
Current consumption	25 mA ³⁾
Switching output	Push-pull: PNP/NPN
Output function	Factory setting: Pin 2 / white (MF): test input, Pin 4 / black: NPN normally closed (light switching), PNP normally open (dark switching)

1) Limit values. Operated in short-circuit protected network: max. 8 A.

2) May not fall below or exceed U_y tolerances.

3) Without load.

4) Signal transit time with resistive load.

5) With light/dark ratio 1:1.

6) A = V_S connections reverse-polarity protected.

7) B = output reverse-polarity protected.

8) D = outputs overcurrent and short-circuit protected.

9) Below T_U = -10 °C a warm-up time is necessary.

Switching mode	Light/dark switching
Output current I_{max}	≤ 50 mA
Response time	≤ 5 ms ⁴⁾
Switching frequency	100 Hz ⁵⁾
Input	MF _{in} = multifunctional input programmable
Circuit protection	A ⁶⁾ B ⁷⁾ D ⁸⁾
Protection class	III
Enclosure rating	IP67
Warm-up time	< 10 min ⁹⁾
Initialization time	< 300 ms

¹⁾ Limit values. Operated in short-circuit protected network: max. 8 A.

²⁾ May not fall below or exceed U_V tolerances.

³⁾ Without load.

⁴⁾ Signal transit time with resistive load.

⁵⁾ With light/dark ratio 1:1.

⁶⁾ A = V_S connections reverse-polarity protected.

⁷⁾ B = output reverse-polarity protected.

⁸⁾ D = outputs overcurrent and short-circuit protected.

⁹⁾ Below $T_u = -10$ °C a warm-up time is necessary.

Mechanics

Dimensions (W x H x D)	12.2 mm x 41.8 mm x 17.3 mm
Housing material	Plastic, MABS, ABS
Optics material	Plastic, PMMA
Weight	10 g
Connection type	Male connector M8, 4-pin

Ambient data

Ambient operating temperature	-40 °C ... +50 °C ¹⁾
Ambient temperature, storage	-40 °C ... +75 °C

¹⁾ As of $T_a = 45$ °C, a max.load current $I_{max} = 50$ mA is permitted.

Smart Task

Smart Task name	Base logics
Logic function	Direct AND OR WINDOW Hysteresis
Timer function	Deactivated Switch-on delay Off delay ON and OFF delay Impulse (one shot)
Inverter	Yes
Switching signal	

Switching signal Q _{L1}	Switching output
Switching signal Q _{L2}	Switching output

Classifications

ECLASS 5.0	27270904
ECLASS 5.1.4	27270904
ECLASS 6.0	27270904
ECLASS 6.2	27270904
ECLASS 7.0	27270904
ECLASS 8.0	27270904
ECLASS 8.1	27270904
ECLASS 9.0	27270904
ECLASS 10.0	27270904
ECLASS 11.0	27270904
ECLASS 12.0	27270903
ETIM 5.0	EC002719
ETIM 6.0	EC002719
ETIM 7.0	EC002719
ETIM 8.0	EC002719
UNSPSC 16.0901	39121528

Dimensional drawing (Dimensions in mm (inch))

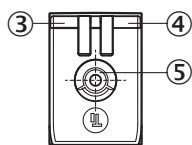
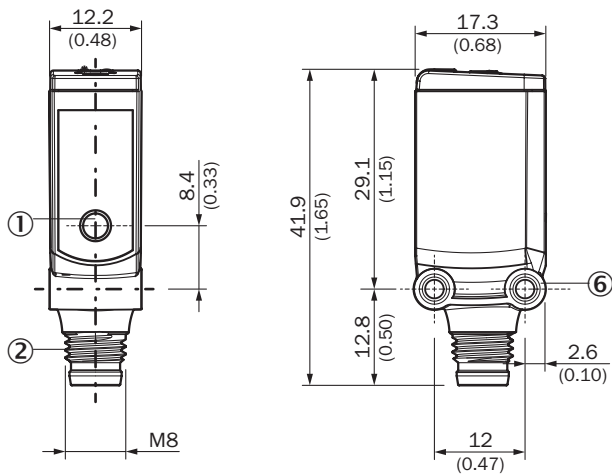

- ① Center of optical axis
- ② Connection
- ③ LED indicator green: power
- ④ LED indicator yellow: Status of received light beam
- ⑤ Single teach-in button
- ⑥ Threaded mounting hole M3

Connection diagram

Cd-450

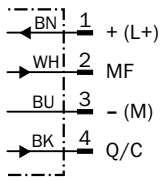

Default: MF = Test

Light spot size

Radius in mm (inch)

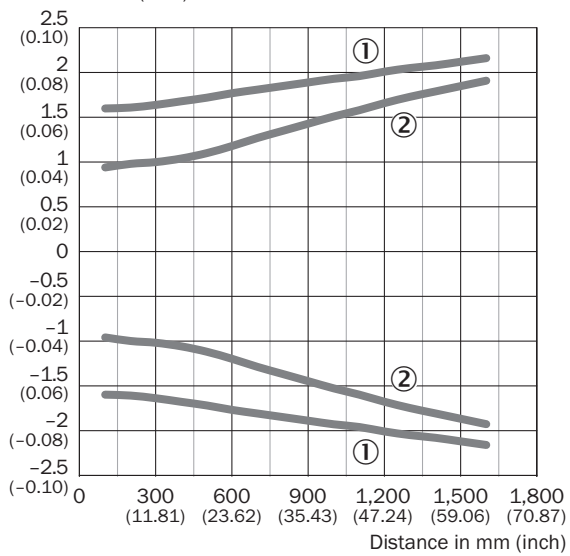

- ① Light spot horizontal
- ② Light spot vertical

Scanning range

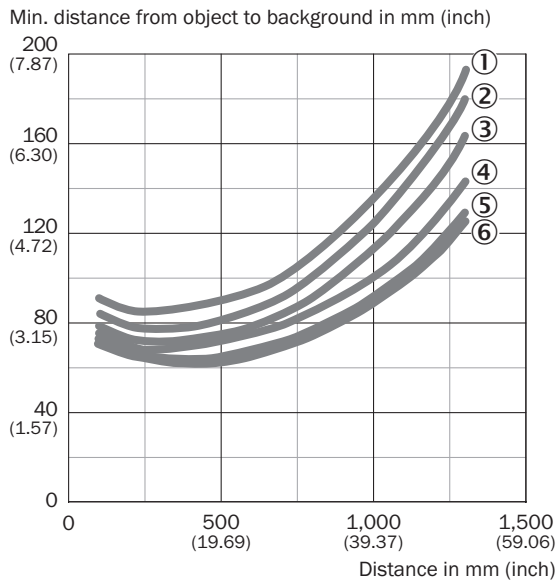

- ① 6 % / 90 % AVG1
- ② 6 % / 90 % AVG2
- ③ 6 % / 90 % AVG4
- ④ 6 % / 90 % AVG8
- ⑤ 6 % / 90 % AVG64
- ⑥ 6 % / 90 % AVG512

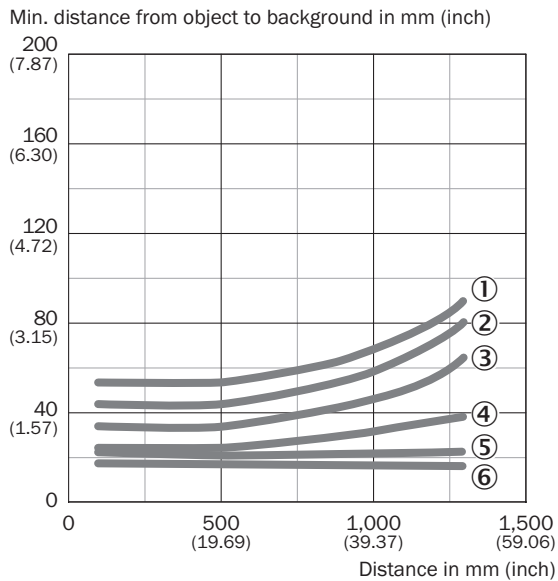

- ① 90 % / 90 % AVG1
- ② 90 % / 90 % AVG2
- ③ 90 % / 90 % AVG4
- ④ 90 % / 90 % AVG8
- ⑤ 90 % / 90 % AVG64
- ⑥ 90 % / 90 % AVG512

Repeatability

Repeatability in mm (inch)

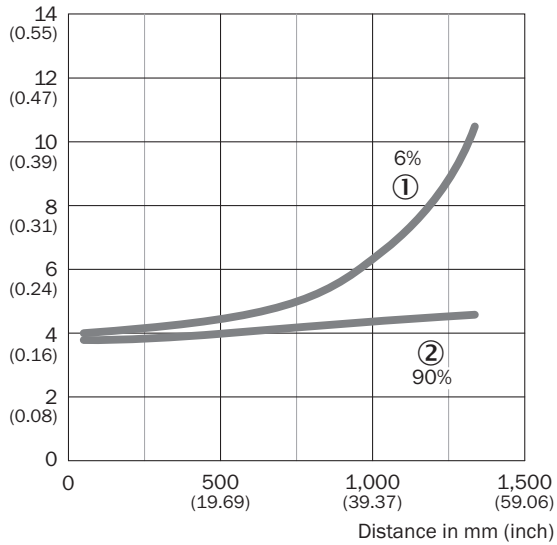

- ① 6 % remission, on black
- ② 90 % remission, on white

Recommended accessories

Other models and accessories → www.sick.com/WTT4_PowerProx

	Brief description	Type	Part no.
Universal bar clamp systems			
	Plate NO8N for universal clamp bracket, Stainless steel 1.4571 (sheet), Stainless steel 1.4408 (clamp), Universal clamp (5322627), mounting hardware	BEF-KHS-NO8N	2051616

SICK AT A GLANCE

SICK is one of the leading manufacturers of intelligent sensors and sensor solutions for industrial applications. A unique range of products and services creates the perfect basis for controlling processes securely and efficiently, protecting individuals from accidents and preventing damage to the environment.

We have extensive experience in a wide range of industries and understand their processes and requirements. With intelligent sensors, we can deliver exactly what our customers need. In application centers in Europe, Asia and North America, system solutions are tested and optimized in accordance with customer specifications. All this makes us a reliable supplier and development partner.

Comprehensive services complete our offering: SICK LifeTime Services provide support throughout the machine life cycle and ensure safety and productivity.

For us, that is “Sensor Intelligence.”

WORLDWIDE PRESENCE:

Contacts and other locations –www.sick.com