

YF2A13-020VB1M2A13

Sensor/actuator cable

SICK
Sensor Intelligence.



Ordering information

| Type | Part no. |
|--------------------|----------|
| YF2A13-020VB1M2A13 | 2096359 |

Other models and accessories → www.sick.com/Sensor_actuator_cable



Detailed technical data

Technical specifications

| | | | | | |
|--------------------------------|--|--------------|-----------------------|---------------------|----------------------|
| Connection type head A | Female connector, M12, 3-pin, straight, A-coded | | | | |
| Connection type head B | Male connector, M12, 3-pin, straight, A-coded | | | | |
| Locking plug connector | Screw connection | | | | |
| Connector material | TPU | | | | |
| Connector color | Black | | | | |
| Locking nut material | Zinc die-cast, nickel-plated | | | | |
| Seal material | FKM | | | | |
| Tightening torque | 0.6 Nm | | | | |
| Width across flats | 13 | | | | |
| Cable | 2 m, 3-wire, PVC | | | | |
| Jacket material | PVC | | | | |
| Jacket color | Gray | | | | |
| Cable diameter | 4.6 mm | | | | |
| Conductor cross section | 0.34 mm ² | | | | |
| Shielding | Unshielded | | | | |
| Bending radius | <table border="0"> <tr> <td style="padding-right: 20px;">Flexible use</td> <td>> 10 x cable diameter</td> </tr> <tr> <td>Stationary position</td> <td>> 5 x cable diameter</td> </tr> </table> | Flexible use | > 10 x cable diameter | Stationary position | > 5 x cable diameter |
| Flexible use | > 10 x cable diameter | | | | |
| Stationary position | > 5 x cable diameter | | | | |
| Nominal voltage, cable | 300 V AC | | | | |
| Test voltage, cable | 2,000 V AC | | | | |
| Reference voltage | <table border="0"> <tr> <td>250 V AC</td> </tr> <tr> <td>250 V DC</td> </tr> </table> | 250 V AC | 250 V DC | | |
| 250 V AC | | | | | |
| 250 V DC | | | | | |
| Rated impulse voltage | 2.5 kV | | | | |
| Current loading | 4 A | | | | |
| Signal type | Sensor/actuator cable | | | | |
| Application | Zones with chemicals Uncontaminated zones | | | | |
| Authorizations | CE UL | | | | |
| UL File No. | E335179 | | | | |

| | |
|---------------------------------------|--|
| Enclosure rating | IP65 / IP66K / IP67 |
| Operating temperature | |
| Flexible use | -5 °C ... +80 °C |
| Stationary position | -30 °C ... +80 °C |
| Head | -25 °C ... +85 °C |
| Contamination rating | 3 |
| Insulation resistance | 100 MΩ |
| Overvoltage category | III |
| Specific insulation resistance | 30 mΩ |
| Thermal resistance, piping | Flame retardant according to UL 1581 VW1 / CSA FT1 |

Classifications

| | |
|-----------------------|----------|
| ECLASS 5.0 | 19030312 |
| ECLASS 5.1.4 | 19030312 |
| ECLASS 6.0 | 27060304 |
| ECLASS 6.2 | 27060304 |
| ECLASS 7.0 | 27060304 |
| ECLASS 8.0 | 27060304 |
| ECLASS 8.1 | 27060304 |
| ECLASS 9.0 | 27060304 |
| ECLASS 10.0 | 27060304 |
| ECLASS 11.0 | 27060304 |
| ECLASS 12.0 | 27060304 |
| ETIM 5.0 | EC000830 |
| ETIM 6.0 | EC000830 |
| ETIM 7.0 | EC003249 |
| ETIM 8.0 | EC003249 |
| UNSPSC 16.0901 | 26121604 |

Dimensional drawing (Dimensions in mm (inch))

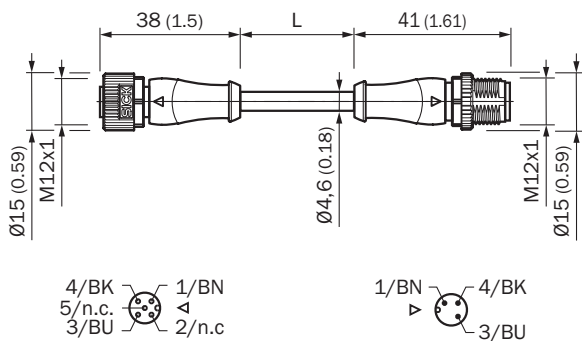

Recommended accessories

Other models and accessories → www.sick.com/Sensor_actuator_cable

| | Brief description | Type | Part no. |
|---|--|------------------|----------|
| Other mounting accessories | | | |
|  | 1 piece, M12 mounting key set for SW13 with calibrated torque 0.6 Nm | TOOL-TW06M12AF13 | 5337208 |

SICK AT A GLANCE

SICK is one of the leading manufacturers of intelligent sensors and sensor solutions for industrial applications. A unique range of products and services creates the perfect basis for controlling processes securely and efficiently, protecting individuals from accidents and preventing damage to the environment.

We have extensive experience in a wide range of industries and understand their processes and requirements. With intelligent sensors, we can deliver exactly what our customers need. In application centers in Europe, Asia and North America, system solutions are tested and optimized in accordance with customer specifications. All this makes us a reliable supplier and development partner.

Comprehensive services complete our offering: SICK LifeTime Services provide support throughout the machine life cycle and ensure safety and productivity.

For us, that is “Sensor Intelligence.”

WORLDWIDE PRESENCE:

Contacts and other locations –www.sick.com