



YF2A13-030VB1M2A13

Sensor/actuator cable

SICK
Sensor Intelligence.



Ordering information

Type	Part no.
YF2A13-030VB1M2A13	2113000

Other models and accessories → www.sick.com/Sensor_actuator_cable



Detailed technical data

Technical specifications

Connection type head A	Female connector, M12, 3-pin, straight, A-coded				
Connection type head B	Male connector, M12, 3-pin, straight, A-coded				
Locking plug connector	Screw connection				
Connector material	TPU				
Connector color	Black				
Locking nut material	Zinc die-cast, nickel-plated				
Seal material	FKM				
Tightening torque	0.6 Nm				
Width across flats	13				
Cable	3 m, 3-wire, PVC				
Jacket material	PVC				
Jacket color	Gray				
Cable diameter	4.6 mm				
Conductor cross section	0.34 mm ²				
Shielding	Unshielded				
Bending radius	<table border="0"> <tr> <td style="padding-right: 20px;">Flexible use</td> <td>> 10 x cable diameter</td> </tr> <tr> <td>Stationary position</td> <td>> 5 x cable diameter</td> </tr> </table>	Flexible use	> 10 x cable diameter	Stationary position	> 5 x cable diameter
Flexible use	> 10 x cable diameter				
Stationary position	> 5 x cable diameter				
Nominal voltage, cable	300 V AC				
Test voltage, cable	2,000 V AC				
Reference voltage	<table border="0"> <tr> <td>250 V AC</td> </tr> <tr> <td>250 V DC</td> </tr> </table>	250 V AC	250 V DC		
250 V AC					
250 V DC					
Rated impulse voltage	2.5 kV				
Current loading	4 A				
Signal type	Sensor/actuator cable				
Application	Zones with chemicals Uncontaminated zones				
Authorizations	CE UL				
UL File No.	E335179				

Enclosure rating	IP65 / IP66K / IP67
Operating temperature	
Flexible use	-5 °C ... +80 °C
Stationary position	-30 °C ... +80 °C
Head	-25 °C ... +85 °C
Contamination rating	3
Insulation resistance	100 MΩ
Overvoltage category	III
Specific insulation resistance	30 mΩ
Thermal resistance, piping	Flame retardant according to UL 1581 VW1 / CSA FT1

Classifications

ECLASS 5.0	19030312
ECLASS 5.1.4	19030312
ECLASS 6.0	27060304
ECLASS 6.2	27060304
ECLASS 7.0	27060304
ECLASS 8.0	27060304
ECLASS 8.1	27060304
ECLASS 9.0	27060304
ECLASS 10.0	27060304
ECLASS 11.0	27060304
ECLASS 12.0	27060304
ETIM 5.0	EC000830
ETIM 6.0	EC000830
ETIM 7.0	EC003249
ETIM 8.0	EC003249
UNSPSC 16.0901	26121604

Dimensional drawing (Dimensions in mm (inch))

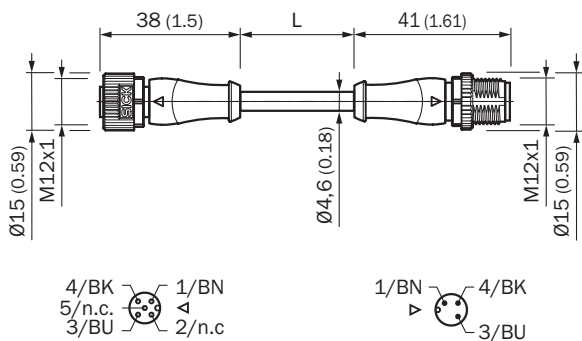

SICK AT A GLANCE

SICK is one of the leading manufacturers of intelligent sensors and sensor solutions for industrial applications. A unique range of products and services creates the perfect basis for controlling processes securely and efficiently, protecting individuals from accidents and preventing damage to the environment.

We have extensive experience in a wide range of industries and understand their processes and requirements. With intelligent sensors, we can deliver exactly what our customers need. In application centers in Europe, Asia and North America, system solutions are tested and optimized in accordance with customer specifications. All this makes us a reliable supplier and development partner.

Comprehensive services complete our offering: SICK LifeTime Services provide support throughout the machine life cycle and ensure safety and productivity.

For us, that is “Sensor Intelligence.”

WORLDWIDE PRESENCE:

Contacts and other locations –www.sick.com