

YF8U14-020UA3M8U14

Sensor/actuator cable

SICK
Sensor Intelligence.



Ordering information

Type	Part no.
YF8U14-020UA3M8U14	2096347

Other models and accessories → www.sick.com/Sensor_actuator_cable



Detailed technical data

Technical specifications

Connection type head A	Female connector, M8, 4-pin, straight, A-coded						
Connection type head B	Male connector, M8, 4-pin, straight, A-coded						
Locking plug connector	Screw connection						
Connector material	TPU						
Connector color	Black						
Locking nut material	Zinc die-cast, nickel-plated (female connector), Nickel-plated brass (male connector)						
Seal material	FKM						
Tightening torque	0.4 Nm						
Width across flats	9						
Cable	2 m, 4-wire, PUR, halogen-free						
Jacket material	PUR, halogen-free						
Jacket color	Black						
Cable diameter	4.5 mm						
Conductor cross section	0.25 mm ²						
Shielding	Unshielded						
Bending radius	<table border="0"> <tr> <td>Flexible use</td> <td>> 10 x cable diameter</td> </tr> <tr> <td>Stationary position</td> <td>> 5 x cable diameter</td> </tr> <tr> <td>Drag chain operation</td> <td>> 10 x cable diameter</td> </tr> </table>	Flexible use	> 10 x cable diameter	Stationary position	> 5 x cable diameter	Drag chain operation	> 10 x cable diameter
Flexible use	> 10 x cable diameter						
Stationary position	> 5 x cable diameter						
Drag chain operation	> 10 x cable diameter						
Bending cycles	10,000,000						
Nominal voltage, cable	300 V AC						
Test voltage, cable	2,500 V AC						
Reference voltage	<table border="0"> <tr> <td>50 V AC</td> </tr> <tr> <td>60 V DC</td> </tr> </table>	50 V AC	60 V DC				
50 V AC							
60 V DC							
Rated impulse voltage	1.5 kV						
Current loading	4 A						
Traversing speed	3 m/s						
Travelling distance	10 m						
Acceleration	≤ 10 m/s ²						

Signal type	Sensor/actuator cable								
Torsion force	180° / 1 m								
Torsion cycles	2,000,000								
Cycles per minutes	35								
Application	Uncontaminated zones Zones with oils and lubricants Robot Drag chain operation								
Authorizations	UL								
UL File No.	E335179								
Enclosure rating	IP65 / IP66K / IP67								
Operating temperature	<table border="0"> <tr> <td>Flexible use</td> <td>-25 °C ... +80 °C</td> </tr> <tr> <td>Stationary position</td> <td>-40 °C ... +80 °C</td> </tr> <tr> <td>Drag chain operation</td> <td>-25 °C ... +80 °C</td> </tr> <tr> <td>Head</td> <td>-25 °C ... +85 °C</td> </tr> </table>	Flexible use	-25 °C ... +80 °C	Stationary position	-40 °C ... +80 °C	Drag chain operation	-25 °C ... +80 °C	Head	-25 °C ... +85 °C
Flexible use	-25 °C ... +80 °C								
Stationary position	-40 °C ... +80 °C								
Drag chain operation	-25 °C ... +80 °C								
Head	-25 °C ... +85 °C								
Contamination rating	3								
Insulation resistance	100 MΩ								
Overvoltage category	III								
Specific insulation resistance	30 mΩ								
Thermal resistance, piping	Flame retardant according to UL 1581, horizontal flame test/CSA FT2 / IEC 60332-1, IEC 60332-2-2								

Classifications

ECLASS 5.0	19030312
ECLASS 5.1.4	19030312
ECLASS 6.0	27060304
ECLASS 6.2	27060304
ECLASS 7.0	27060304
ECLASS 8.0	27060304
ECLASS 8.1	27060304
ECLASS 9.0	27060304
ECLASS 10.0	27060304
ECLASS 11.0	27060304
ECLASS 12.0	27060304
ETIM 5.0	EC000830
ETIM 6.0	EC000830
ETIM 7.0	EC003249
ETIM 8.0	EC003249
UNSPSC 16.0901	26121604

Dimensional drawing (Dimensions in mm (inch))

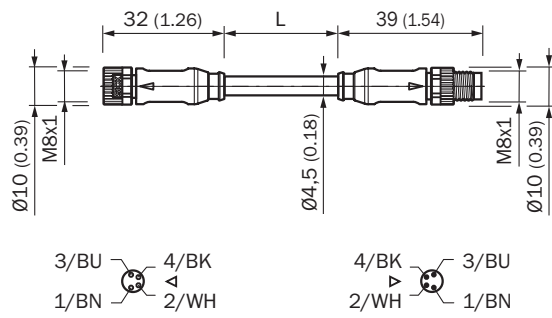

Recommended accessories

Other models and accessories → www.sick.com/Sensor_actuator_cable

	Brief description	Type	Part no.
Other mounting accessories			
	1 piece, M8 mounting key set for SW9 with calibrated torque 0.4 Nm	TOOL-TW04M08AF09	5337207

SICK AT A GLANCE

SICK is one of the leading manufacturers of intelligent sensors and sensor solutions for industrial applications. A unique range of products and services creates the perfect basis for controlling processes securely and efficiently, protecting individuals from accidents and preventing damage to the environment.

We have extensive experience in a wide range of industries and understand their processes and requirements. With intelligent sensors, we can deliver exactly what our customers need. In application centers in Europe, Asia and North America, system solutions are tested and optimized in accordance with customer specifications. All this makes us a reliable supplier and development partner.

Comprehensive services complete our offering: SICK LifeTime Services provide support throughout the machine life cycle and ensure safety and productivity.

For us, that is “Sensor Intelligence.”

WORLDWIDE PRESENCE:

Contacts and other locations –www.sick.com