



YM2D24-010EF4M2D24

Industrial Ethernet cables and fieldbus cables

SICK
Sensor Intelligence.



Ordering information

Type	Part no.
YM2D24-010EF4M2D24	2112839

Other models and accessories → www.sick.com/Industrial_Ethernet_cables_and_fieldbus_cables



Detailed technical data

Technical specifications

Connection type head A	Male connector, M12, 4-pin, straight, D-coded						
Connection type head B	Male connector, M12, 4-pin, straight, D-coded						
Locking plug connector	Screw connection						
Connector material	TPU						
Connector color	Black						
Locking nut material	Zinc die-cast, nickel-plated						
Tightening torque	0.6 Nm						
Width across flats	13						
Cable	1 m, 4-wire, TPE						
Jacket material	TPE						
Jacket color	Turquoise						
Cable diameter	6.6 mm						
Shielding	Shielded						
Bending radius	<table border="0"> <tr> <td>Flexible use</td> <td>> 10 x cable diameter</td> </tr> <tr> <td>Stationary position</td> <td>> 8 x cable diameter</td> </tr> <tr> <td>Drag chain operation</td> <td>> 10 x cable diameter</td> </tr> </table>	Flexible use	> 10 x cable diameter	Stationary position	> 8 x cable diameter	Drag chain operation	> 10 x cable diameter
Flexible use	> 10 x cable diameter						
Stationary position	> 8 x cable diameter						
Drag chain operation	> 10 x cable diameter						
Bending cycles	1,000,000						
Nominal voltage, cable	600 V AC						
Test voltage, cable	1,500 V AC						
Reference voltage	<table border="0"> <tr> <td>48 V AC</td> </tr> <tr> <td>60 V DC</td> </tr> </table>	48 V AC	60 V DC				
48 V AC							
60 V DC							
Rated impulse voltage	1.5 kV						
Current loading	4 A						
Traversing speed	1.2 m/s						
Travelling distance	0.6 m						
Acceleration	≤ 2.4 m/s ²						
Signal type	Ethernet, EtherNet/IP™						
Transmission characteristics	CAT5e						

Data transmission rate	≤ 0.1 Gbit/s
Torsion force	270° / 1 m
Torsion cycles	3,000,000
Cycles per minutes	60
Application	Drag chain operation Robot Zones with oils and lubricants
Authorizations	CE UL
Enclosure rating	IP65 / IP66K / IP67
Operating temperature	
Stationary position	-40 °C ... +80 °C
Head	-25 °C ... +85 °C
Contamination rating	3
Insulation resistance	> 100 MΩ
Overvoltage category	III
Specific insulation resistance	< 30 mΩ

Classifications

ECLASS 5.0	27061801
ECLASS 5.1.4	27061801
ECLASS 6.0	27061801
ECLASS 6.2	27061801
ECLASS 7.0	27061801
ECLASS 8.0	27061801
ECLASS 8.1	27061801
ECLASS 9.0	27061801
ECLASS 10.0	27061801
ECLASS 11.0	27061801
ECLASS 12.0	27061801
ETIM 5.0	EC002599
ETIM 6.0	EC002599
ETIM 7.0	EC002599
ETIM 8.0	EC002599
UNSPSC 16.0901	26121604

Dimensional drawing (Dimensions in mm (inch))

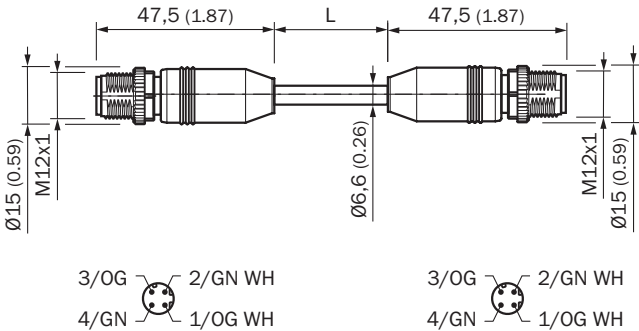

SICK AT A GLANCE

SICK is one of the leading manufacturers of intelligent sensors and sensor solutions for industrial applications. A unique range of products and services creates the perfect basis for controlling processes securely and efficiently, protecting individuals from accidents and preventing damage to the environment.

We have extensive experience in a wide range of industries and understand their processes and requirements. With intelligent sensors, we can deliver exactly what our customers need. In application centers in Europe, Asia and North America, system solutions are tested and optimized in accordance with customer specifications. All this makes us a reliable supplier and development partner.

Comprehensive services complete our offering: SICK LifeTime Services provide support throughout the machine life cycle and ensure safety and productivity.

For us, that is “Sensor Intelligence.”

WORLDWIDE PRESENCE:

Contacts and other locations –www.sick.com