



## YM2X18-100EG2MRJA8

Industrial Ethernet cables and fieldbus cables

**SICK**  
Sensor Intelligence.



## Ordering information

Type	Part no.
YM2X18-100EG2MRJA8	2113237

Other models and accessories → [www.sick.com/Industrial\\_Ethernet\\_cables\\_and\\_fieldbus\\_cables](http://www.sick.com/Industrial_Ethernet_cables_and_fieldbus_cables)



## Detailed technical data

### Technical specifications

<b>Connection type head A</b>	Male connector, M12, 8-pin, straight, X-coded						
<b>Connection type head B</b>	Male connector, RJ45, 8-pin, straight						
<b>Locking plug connector</b>	Screw-on connection (M12), snap-in locking (RJ45)						
<b>Connector material</b>	TPU						
<b>Connector color</b>	Black						
<b>Locking nut material</b>	Zinc die-cast, nickel-plated						
<b>Tightening torque</b>	0.6 Nm						
<b>Width across flats</b>	13						
<b>Cable</b>	10 m, 8-wire, TPE						
<b>Jacket material</b>	TPE						
<b>Jacket color</b>	Turquoise						
<b>Cable diameter</b>	7.4 mm						
<b>Conductor cross section</b>	0,14 mm <sup>2</sup>						
<b>Shielding</b>	Shielded						
<b>Bending radius</b>	<table border="0"> <tr> <td>Flexible use</td> <td>&gt; 10 x cable diameter</td> </tr> <tr> <td>Stationary position</td> <td>&gt; 5 x cable diameter</td> </tr> <tr> <td>Drag chain operation</td> <td>&gt; 20 x cable diameter</td> </tr> </table>	Flexible use	> 10 x cable diameter	Stationary position	> 5 x cable diameter	Drag chain operation	> 20 x cable diameter
Flexible use	> 10 x cable diameter						
Stationary position	> 5 x cable diameter						
Drag chain operation	> 20 x cable diameter						
<b>Bending cycles</b>	10,000,000						
<b>Nominal voltage, cable</b>	600 V AC						
<b>Test voltage, cable</b>	1,500 V AC						
<b>Reference voltage</b>	<table border="0"> <tr> <td>48 V AC</td> </tr> <tr> <td>60 V DC</td> </tr> </table>	48 V AC	60 V DC				
48 V AC							
60 V DC							
<b>Rated impulse voltage</b>	1 kV						
<b>Current loading</b>	0.5 A						
<b>Traversing speed</b>	1.2 m/s						
<b>Travelling distance</b>	0.6 m						
<b>Acceleration</b>	≤ 2.4 m/s <sup>2</sup>						
<b>Signal type</b>	Ethernet, Gigabit Ethernet						

<b>Transmission characteristics</b>	CAT6A
<b>Data transmission rate</b>	≤ 10 Gbit/s
<b>Torsion force</b>	270° / 1 m
<b>Torsion cycles</b>	3,000,000
<b>Cycles per minutes</b>	60
<b>Application</b>	Drag chain operation Robot Zones with oils and lubricants
<b>Authorizations</b>	CE UL
<b>UL File No.</b>	E513908
<b>Enclosure rating</b>	IP65/ IP67 (M12), IP20 (RJ45)
<b>Operating temperature</b>	
Stationary position	-40 °C ... +80 °C
Head	-25 °C ... +85 °C
<b>Contamination rating</b>	3
<b>Insulation resistance</b>	> 100 mΩ
<b>Overvoltage category</b>	III
<b>Specific insulation resistance</b>	< 30 mΩ
<b>Thermal resistance, piping</b>	Flame-retardant

## Classifications

<b>ECLASS 5.0</b>	19030312
<b>ECLASS 5.1.4</b>	19030312
<b>ECLASS 6.0</b>	27060304
<b>ECLASS 6.2</b>	27060304
<b>ECLASS 7.0</b>	27060304
<b>ECLASS 8.0</b>	27060304
<b>ECLASS 8.1</b>	27060304
<b>ECLASS 9.0</b>	27060304
<b>ECLASS 10.0</b>	27060304
<b>ECLASS 11.0</b>	27060304
<b>ECLASS 12.0</b>	27060304
<b>ETIM 5.0</b>	EC000830
<b>ETIM 6.0</b>	EC000830
<b>ETIM 7.0</b>	EC003249
<b>ETIM 8.0</b>	EC003249
<b>UNSPSC 16.0901</b>	26121604

Dimensional drawing (Dimensions in mm (inch))

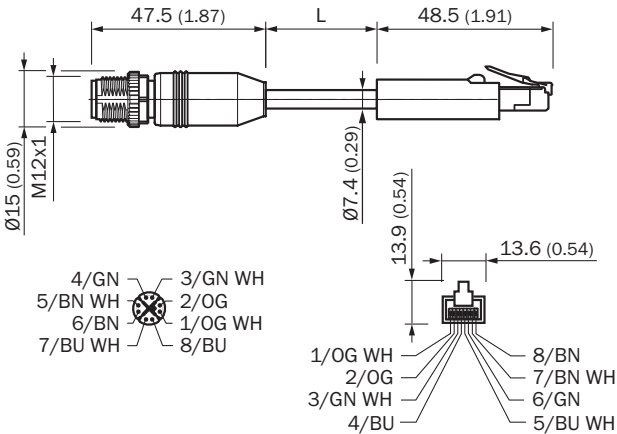

## SICK AT A GLANCE

SICK is one of the leading manufacturers of intelligent sensors and sensor solutions for industrial applications. A unique range of products and services creates the perfect basis for controlling processes securely and efficiently, protecting individuals from accidents and preventing damage to the environment.

We have extensive experience in a wide range of industries and understand their processes and requirements. With intelligent sensors, we can deliver exactly what our customers need. In application centers in Europe, Asia and North America, system solutions are tested and optimized in accordance with customer specifications. All this makes us a reliable supplier and development partner.

Comprehensive services complete our offering: SICK LifeTime Services provide support throughout the machine life cycle and ensure safety and productivity.

For us, that is “Sensor Intelligence.”

## WORLDWIDE PRESENCE:

Contacts and other locations –[www.sick.com](http://www.sick.com)