

YMRJA4-250PN1MRJA4

Industrial Ethernet cables and fieldbus cables

SICK
Sensor Intelligence.



Ordering information

Type	Part no.
YMRJA4-250PN1MRJA4	2122969

Other models and accessories → www.sick.com/Industrial_Ethernet_cables_and_fieldbus_cables

Detailed technical data

Technical specifications

Connection type head A	Male connector, RJ45, 4-pin, straight						
Connection type head B	Male connector, RJ45, 4-pin, straight						
Connector material	TPU						
Connector color	Black						
Cable	25 m, 4-wire, PUR, halogen-free						
Jacket material	PUR, halogen-free						
Jacket color	Green						
Cable diameter	6.7 mm						
Conductor cross section	0.34 mm ²						
Shielding	Shielded						
Bending radius	<table border="0"> <tr> <td>Flexible use</td> <td>> 12 x cable diameter</td> </tr> <tr> <td>Stationary position</td> <td>> 5 x cable diameter</td> </tr> <tr> <td>Drag chain operation</td> <td>> 12 x cable diameter</td> </tr> </table>	Flexible use	> 12 x cable diameter	Stationary position	> 5 x cable diameter	Drag chain operation	> 12 x cable diameter
Flexible use	> 12 x cable diameter						
Stationary position	> 5 x cable diameter						
Drag chain operation	> 12 x cable diameter						
Bending cycles	≤ 3,000,000						
Nominal voltage, cable	300 V AC						
Test voltage, cable	2,000 V AC						
Reference voltage	60 V DC						
Rated impulse voltage	1 kV						
Current loading	≤ 1.5 A						
Traversing speed	3.3 m/s						
Travelling distance	5 m						
Acceleration	≤ 2 m/s ²						
Signal type	PROFINET						
Transmission characteristics	CAT5e						
Data transmission rate	≤ 0.1 Gbit/s						
Special feature	Push-pull male connector						
Application	Zones with oils and lubricants Drag chain operation						
UL File No.	E513908						
Enclosure rating	IP20						

Operating temperature	Flexible use	-30 °C ... +70 °C
	Stationary position	-40 °C ... +80 °C
	Drag chain operation	-30 °C ... +70 °C
	Head	-25 °C ... +85 °C
Contamination rating	3	
Overvoltage category	III	
Thermal resistance, piping	Flame retardant acc. to UL 1581 Section 1090, Section 1100 (FT2), IEC 60332-1-2 Std.	

Classifications

ECLASS 5.0	19030312
ECLASS 5.1.4	19030312
ECLASS 6.0	27060304
ECLASS 6.2	27060304
ECLASS 7.0	27060304
ECLASS 8.0	27060304
ECLASS 8.1	27060304
ECLASS 9.0	27060304
ECLASS 10.0	27060304
ECLASS 11.0	27060304
ECLASS 12.0	27060304
ETIM 5.0	EC000830
ETIM 6.0	EC000830
ETIM 7.0	EC003249
ETIM 8.0	EC003249
UNSPSC 16.0901	26121604

Dimensional drawing (Dimensions in mm (inch))

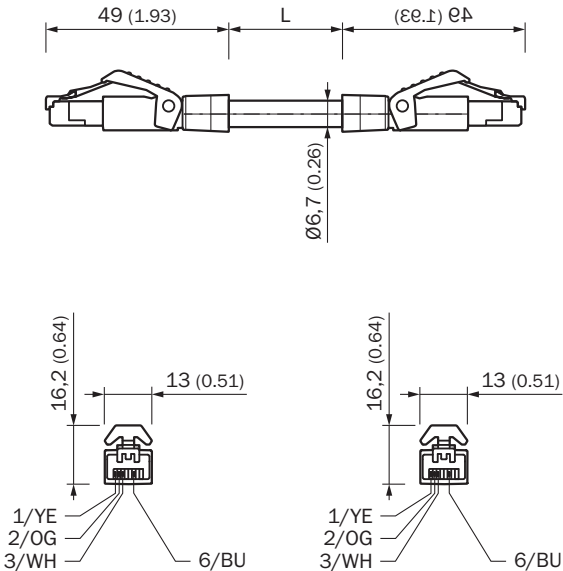

SICK AT A GLANCE

SICK is one of the leading manufacturers of intelligent sensors and sensor solutions for industrial applications. A unique range of products and services creates the perfect basis for controlling processes securely and efficiently, protecting individuals from accidents and preventing damage to the environment.

We have extensive experience in a wide range of industries and understand their processes and requirements. With intelligent sensors, we can deliver exactly what our customers need. In application centers in Europe, Asia and North America, system solutions are tested and optimized in accordance with customer specifications. All this makes us a reliable supplier and development partner.

Comprehensive services complete our offering: SICK LifeTime Services provide support throughout the machine life cycle and ensure safety and productivity.

For us, that is “Sensor Intelligence.”

WORLDWIDE PRESENCE:

Contacts and other locations –www.sick.com