

## YMRJA8-080EG1MRJA8

Industrial Ethernet cables and fieldbus cables

**SICK**  
Sensor Intelligence.



## Ordering information

Type	Part no.
YMRJA8-080EG1MRJA8	2137366

Other models and accessories → [www.sick.com/Industrial\\_Ethernet\\_cables\\_and\\_fieldbus\\_cables](http://www.sick.com/Industrial_Ethernet_cables_and_fieldbus_cables)



## Detailed technical data

### Technical specifications

<b>Connection type head A</b>	Male connector, RJ45, 8-pin, straight
<b>Connection type head B</b>	Male connector, RJ45, 8-pin, straight
<b>Connector material</b>	TPU
<b>Connector color</b>	Black
<b>Cable</b>	8 m, 8-wire, PUR, halogen-free
<b>Jacket material</b>	PUR, halogen-free
<b>Jacket color</b>	Green
<b>Cable diameter</b>	6.4 mm
<b>Conductor cross section</b>	0,14 mm <sup>2</sup>
<b>Shielding</b>	Shielded
<b>Bending radius</b>	
Flexible use	> 10 x cable diameter
Stationary position	> 8 x cable diameter
<b>Nominal voltage, cable</b>	125 V AC
<b>Test voltage, cable</b>	1,000 V AC
<b>Reference voltage</b>	
	48 V AC
	60 V DC
<b>Signal type</b>	Ethernet, Gigabit Ethernet
<b>Transmission characteristics</b>	CAT6A
<b>Data transmission rate</b>	≤ 10 Gbit/s
<b>Application</b>	Zones with oils and lubricants
<b>Authorizations</b>	CE UL
<b>UL File No.</b>	E513908
<b>Enclosure rating</b>	IP20
<b>Operating temperature</b>	
Stationary position	-40 °C ... +80 °C
Head	-25 °C ... +85 °C
<b>Contamination rating</b>	3

<b>Insulation resistance</b>	> 100 mΩ
<b>Specific insulation resistance</b>	< 30 mΩ
<b>Thermal resistance, piping</b>	Flame retardant acc. to UL 1581 Section 1090, Section 1100 (FT2), Section 1080 (VW-1) / IEC 60332-1-2

## Classifications

<b>ECLASS 5.0</b>	19030312
<b>ECLASS 5.1.4</b>	19030312
<b>ECLASS 6.0</b>	27060304
<b>ECLASS 6.2</b>	27060304
<b>ECLASS 7.0</b>	27060304
<b>ECLASS 8.0</b>	27060304
<b>ECLASS 8.1</b>	27060304
<b>ECLASS 9.0</b>	27060304
<b>ECLASS 10.0</b>	27060304
<b>ECLASS 11.0</b>	27060304
<b>ECLASS 12.0</b>	27060304
<b>ETIM 5.0</b>	EC000830
<b>ETIM 6.0</b>	EC000830
<b>ETIM 7.0</b>	EC003249
<b>ETIM 8.0</b>	EC003249
<b>UNSPSC 16.0901</b>	26121604

## Dimensional drawing (Dimensions in mm (inch))

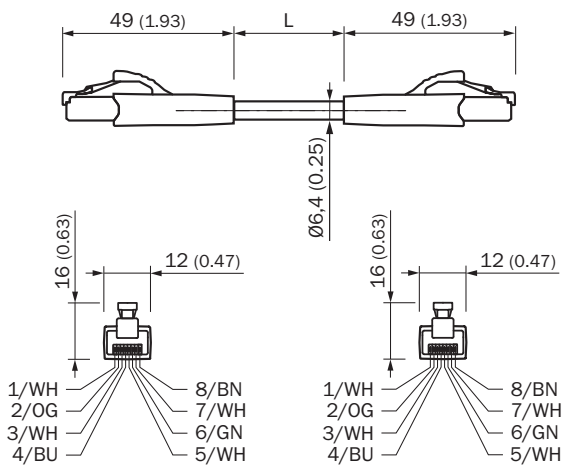

## SICK AT A GLANCE

SICK is one of the leading manufacturers of intelligent sensors and sensor solutions for industrial applications. A unique range of products and services creates the perfect basis for controlling processes securely and efficiently, protecting individuals from accidents and preventing damage to the environment.

We have extensive experience in a wide range of industries and understand their processes and requirements. With intelligent sensors, we can deliver exactly what our customers need. In application centers in Europe, Asia and North America, system solutions are tested and optimized in accordance with customer specifications. All this makes us a reliable supplier and development partner.

Comprehensive services complete our offering: SICK LifeTime Services provide support throughout the machine life cycle and ensure safety and productivity.

For us, that is “Sensor Intelligence.”

## WORLDWIDE PRESENCE:

Contacts and other locations –[www.sick.com](http://www.sick.com)