

ZLM1-B1121A10

ZoneControl

MULTITASK PHOTOELECTRIC SENSORS

SICK
Sensor Intelligence.

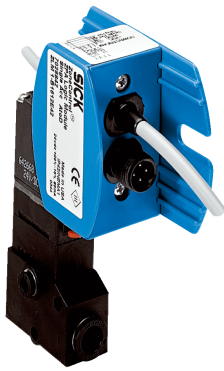

Illustration may differ



Ordering information

Type	Part no.
ZLM1-B1121A10	7027760

Other models and accessories → www.sick.com/ZoneControl

Detailed technical data

Features

Actuator	Pneumatic, valve on board
Max. number of sensors	Approx. 30 ¹⁾ Approx. 50 ²⁾
Logical principle of operation	Single accumulation
Type of Release	Single release, block (slug) release
Dimensions (W x H x D)	31 mm x 110 mm x 83 mm
Special applications	ZoneControl

¹⁾ When powerd from the end of the IR daisy chain.

²⁾ When powerd from center of the IR daisy chain.

Mechanics/electronics

Supply voltage U_B	≥ 21.6 V DC ¹⁾
Ripple	< 5 V _{pp} ²⁾
Current consumption	60 mA ³⁾
Switching output	PNP
Signal voltage PNP HIGH/LOW	Approx. $V_S - 0.5$ V / 0 V
Output current $I_{max.}$	≤ 100 mA
Response time	2.5 ms
Switching frequency	200 Hz

¹⁾ Limit values.

²⁾ May not fall below or exceed U_V tolerances.

³⁾ Without load and valve deenergized.

⁴⁾ Do not bend below 0 °C.

⁵⁾ A = V_S connections reverse-polarity protected.

⁶⁾ C = interference suppression.

⁷⁾ D = outputs overcurrent and short-circuit protected.

⁸⁾ Reference voltage: 50 V DC.

⁹⁾ Other valve types available on request.

Connection type	Cable with female connector, M8, 4-pin, 0.5 m ⁴⁾
Connection type for daisy chain	Cable with M12 male connector, 4-pin 1.2 m
Cable material	Plastic, PVC
Circuit protection	A ⁵⁾ C ⁶⁾ D ⁷⁾
Protection class	III ⁸⁾
Housing material	Plastic, ABS
Enclosure rating	IP40
Shock and vibration resistance	According to IEC 68
Ambient operating temperature	-10 °C ... +55 °C
Ambient temperature, storage	-40 °C ... +75 °C
Medium for valves	Compressed air or neutral gases filtered, non-lubricated or lubricated
Design solenoid valve	3/2-way valve ⁹⁾
Mode of operation solenoid valve	Air to Drive (NC)
Connection type solenoid valve	Compressed air 3/8 " diameter, control line 1/4 " diameter
Coil ratings	24 V DC 1 W
Air flow rate	40 NI/min
Ventilation capacity	40 NI/min
Operating pressure range	0 bar ... 4.5 bar
Response time solenoid valve	Partially open, 10 ms Open, 23 ms Close, 21 ms

¹⁾ Limit values.

²⁾ May not fall below or exceed U_y tolerances.

³⁾ Without load and valve deenergized.

⁴⁾ Do not bend below 0 °C.

⁵⁾ A = V_S connections reverse-polarity protected.

⁶⁾ C = interference suppression.

⁷⁾ D = outputs overcurrent and short-circuit protected.

⁸⁾ Reference voltage: 50 V DC.

⁹⁾ Other valve types available on request.

Pneumatic

Coil ratings	24 V DC 1 W
Medium for valves	Compressed air or neutral gases filtered, non-lubricated or lubricated
Design solenoid valve	3/2-way valve ¹⁾
Connection type solenoid valve	Compressed air 3/8 " diameter, control line 1/4 " diameter
Air flow rate	40 NI/min
Ventilation capacity	40 NI/min
Operating pressure range	0 bar ... 4.5 bar
Response time solenoid valve	Partially open 10 ms Open 23 ms Close 21 ms

¹⁾ Other valve types available on request.

Classifications

ECLASS 5.0	27270902
ECLASS 5.1.4	27270902
ECLASS 6.0	27270902
ECLASS 6.2	27270902
ECLASS 7.0	27270902
ECLASS 8.0	27270902
ECLASS 8.1	27270902
ECLASS 9.0	27270902
ECLASS 10.0	27270902
ECLASS 11.0	27270902
ECLASS 12.0	27270902
ETIM 5.0	EC002717
ETIM 6.0	EC002717
ETIM 7.0	EC002717
ETIM 8.0	EC002717
UNSPSC 16.0901	39121528

Connection diagram

Cd-263

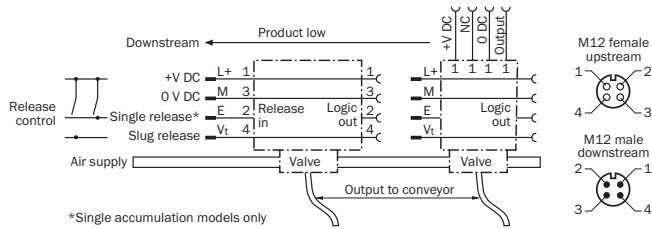

Dimensional drawing (Dimensions in mm (inch))

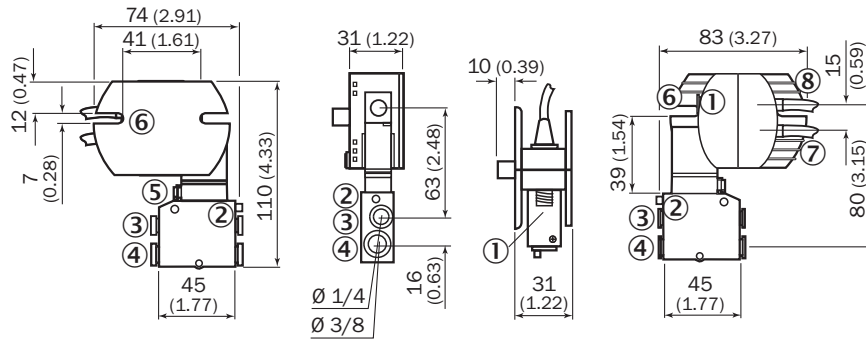

ZLM-B



- ① ZLM series connection, male connector
- ② Exhaust
- ③ Output port (x1)
- ④ Media connector (x2)
- ⑤ Manual override switch
- ⑦ Daisy chain connector, male or female
- ⑧ Sensor connection cable, female
- ⑨ Mounting stud
- ⑩ Anti-rotation stud
- ⑪ Mounting clip

Recommended accessories

Other models and accessories → www.sick.com/ZoneControl

	Brief description	Type	Part no.
Mounting brackets and plates			
	Mounting bracket, steel, zinc coated, mounting hardware included	BEF-WK-WTR	2051786
		BEF-WN-RT/IRT	2074621

SICK AT A GLANCE

SICK is one of the leading manufacturers of intelligent sensors and sensor solutions for industrial applications. A unique range of products and services creates the perfect basis for controlling processes securely and efficiently, protecting individuals from accidents and preventing damage to the environment.

We have extensive experience in a wide range of industries and understand their processes and requirements. With intelligent sensors, we can deliver exactly what our customers need. In application centers in Europe, Asia and North America, system solutions are tested and optimized in accordance with customer specifications. All this makes us a reliable supplier and development partner.

Comprehensive services complete our offering: SICK LifeTime Services provide support throughout the machine life cycle and ensure safety and productivity.

For us, that is “Sensor Intelligence.”

WORLDWIDE PRESENCE:

Contacts and other locations –www.sick.com