



# ZTE18-2AB4B2

Z18 Simple Sense

HYBRID PHOTOELECTRIC SENSORS

**SICK**  
Sensor Intelligence.



Illustration may differ



### Ordering information

Type	Part no.
ZTE18-2AB4B2	1095834

**Included in delivery:** BEF-MU-M18\*1 (1)

Other models and accessories → [www.sick.com/Z18\\_Simple\\_Sense](http://www.sick.com/Z18_Simple_Sense)

### Detailed technical data

#### Features

<b>Functional principle</b>	Photoelectric proximity sensor
<b>Functional principle detail</b>	Energetic
<b>Dimensions (W x H x D)</b>	13.6 mm x 34.8 mm x 21.9 mm
<b>Housing design (light emission)</b>	Hybrid
<b>Thread diameter (housing)</b>	M18
<b>Mounting system type</b>	M18, head/side (24.1 ... 25.4 mm)
<b>Housing color</b>	Blue
<b>Sensing range max.</b>	0 mm ... 700 mm <sup>1)</sup>
<b>Sensing range</b>	0 mm ... 520 mm <sup>2)</sup>
<b>Type of light</b>	Visible red light
<b>Light source</b>	PinPoint LED
<b>Light spot size (distance)</b>	Ø 25 mm (1,000 mm)
<b>Wave length</b>	625 nm

<sup>1)</sup> Object with 90% remission (based on standard white, DIN 5033).

<sup>2)</sup> Object with 6% remission (based on standard white, DIN 5033).

#### Mechanics/electronics

<b>Supply voltage U<sub>B</sub></b>	10 V DC ... 30 V DC
<b>Ripple</b>	< 10 %
<b>Current consumption</b>	≤ 15 mA <sup>1)</sup>
<b>Switching output</b>	Push-pull: PNP/NPN

<sup>1)</sup> Without load.

<sup>2)</sup> Signal transit time with resistive load.

<sup>3)</sup> With light/dark ratio 1:1.

<sup>4)</sup> A = V<sub>S</sub> connections reverse-polarity protected.

<sup>5)</sup> B = inputs and output reverse-polarity protected.

<sup>6)</sup> D = outputs overcurrent and short-circuit protected.

<b>Switching mode</b>	Light switching, Dark switching
<b>Switching output detail</b>	
Switching output Q1	Push-pull: PNP/NPN, Light switching
Switching output Q2	Push-pull: PNP/NPN, Dark switching
<b>Output current I<sub>max.</sub></b>	100 mA
<b>Response time</b>	≤ 1 ms <sup>2)</sup>
<b>Switching frequency</b>	500 kHz <sup>3)</sup>
<b>Connection type</b>	Cable with M12 male connector, 4-pin, 150 mm
<b>Cable material</b>	Plastic, PVC
<b>Conductor cross section</b>	0.13 mm <sup>2</sup>
<b>Circuit protection</b>	A <sup>4)</sup> B <sup>5)</sup> D <sup>6)</sup>
<b>Protection class</b>	III
<b>Weight</b>	4.54 g
<b>Housing material</b>	Plastic, ABS
<b>Optics material</b>	Plastic, PMMA
<b>Enclosure rating</b>	IP67
<b>Ambient operating temperature</b>	-40 °C ... +55 °C
<b>Ambient temperature, storage</b>	-40 °C ... +70 °C
<b>UL File No.</b>	E189383

1) Without load.

2) Signal transit time with resistive load.

3) With light/dark ratio 1:1.

4) A = V<sub>S</sub> connections reverse-polarity protected.

5) B = inputs and output reverse-polarity protected.

6) D = outputs overcurrent and short-circuit protected.

## Connection type/pinouts

<b>Connection type</b>	Cable with M12 male connector, 4-pin, 150 mm
<b>Connection type Detail</b>	
Conductor cross section	0.13 mm <sup>2</sup>
Cable material	Plastic
<b>Pinouts</b>	
BN 1	+ (L+)
WH 2	Q <sub>2</sub>
BU 3	- (M)
BK 4	Q <sub>1</sub>

## Classifications

<b>ECLASS 5.0</b>	27270903
<b>ECLASS 5.1.4</b>	27270903
<b>ECLASS 6.0</b>	27270903
<b>ECLASS 6.2</b>	27270903

<b>ECLASS 7.0</b>	27270903
<b>ECLASS 8.0</b>	27270903
<b>ECLASS 8.1</b>	27270903
<b>ECLASS 9.0</b>	27270903
<b>ECLASS 10.0</b>	27270903
<b>ECLASS 11.0</b>	27270903
<b>ECLASS 12.0</b>	27270903
<b>ETIM 5.0</b>	EC002719
<b>ETIM 6.0</b>	EC002719
<b>ETIM 7.0</b>	EC002719
<b>ETIM 8.0</b>	EC002719
<b>UNSPSC 16.0901</b>	39121528

### Dimensional drawing (Dimensions in mm (inch))

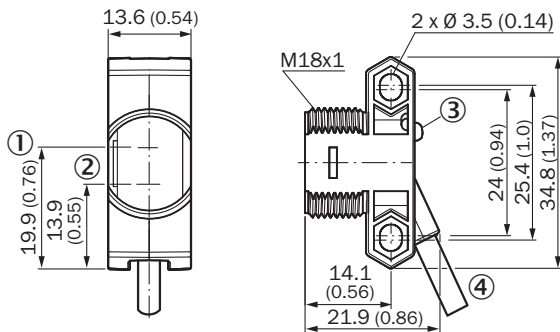

- ① Optical axis, sender
- ② Optical axis, receiver
- ③ LED status indicator
- ④ Connection

### Connection type

Pinouts, see table Technical data: **Connection type/pinouts**

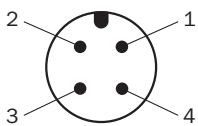

M12 male connector, 4-pin, A-coding

Characteristic curve

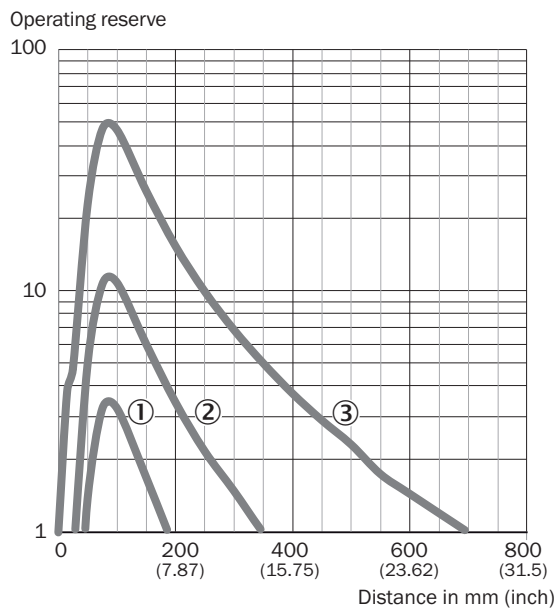

- ① Sensing range on black, 6% remission factor
- ② Sensing range on gray, 18% remission factor
- ③ Sensing range on white, 90% remission factor

Light spot size

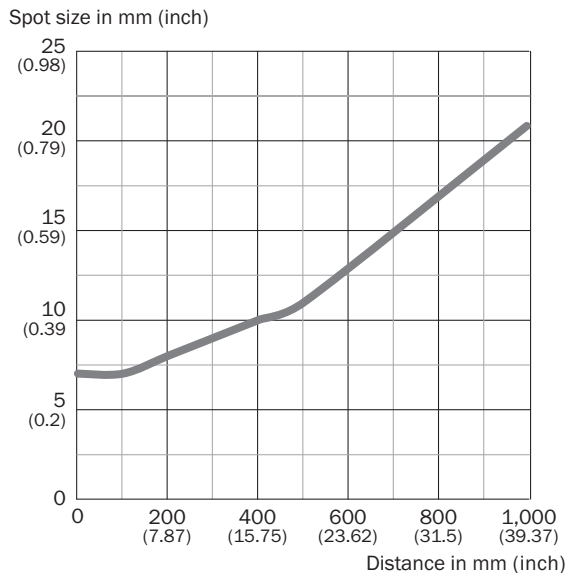

### Sensing range diagram

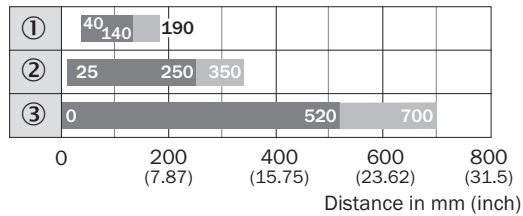



■ Sensing range      ■ Sensing range max.

- ① Sensing range on black, 6% remission factor
- ② Sensing range on gray, 18% remission factor
- ③ Sensing range on white, 90% remission factor

### Recommended accessories

Other models and accessories → [www.sick.com/Z18\\_Simple\\_Sense](http://www.sick.com/Z18_Simple_Sense)

	Brief description	Type	Part no.
Others			
	<ul style="list-style-type: none"> <li>• <b>Connection type head A:</b> Female connector, M12, 4-pin, straight, A-coded</li> <li>• <b>Connection type head B:</b> Flying leads</li> <li>• <b>Signal type:</b> Sensor/actuator cable</li> <li>• <b>Cable:</b> 5 m, 4-wire, PVC</li> <li>• <b>Description:</b> Sensor/actuator cable, unshielded</li> <li>• <b>Application:</b> Zones with chemicals, Uncontaminated zones</li> </ul>	YF2A14-050VB3XLEAX	2096235
	<ul style="list-style-type: none"> <li>• <b>Connection type head A:</b> Male connector, M12, 4-pin, straight, A-coded</li> <li>• <b>Description:</b> Unshielded</li> <li>• <b>Connection systems:</b> Screw-type terminals</li> <li>• <b>Permitted cross-section:</b> ≤ 0.75 mm<sup>2</sup></li> </ul>	STE-1204-G	6009932

## SICK AT A GLANCE

SICK is one of the leading manufacturers of intelligent sensors and sensor solutions for industrial applications. A unique range of products and services creates the perfect basis for controlling processes securely and efficiently, protecting individuals from accidents and preventing damage to the environment.

We have extensive experience in a wide range of industries and understand their processes and requirements. With intelligent sensors, we can deliver exactly what our customers need. In application centers in Europe, Asia and North America, system solutions are tested and optimized in accordance with customer specifications. All this makes us a reliable supplier and development partner.

Comprehensive services complete our offering: SICK LifeTime Services provide support throughout the machine life cycle and ensure safety and productivity.

For us, that is “Sensor Intelligence.”

## WORLDWIDE PRESENCE:

Contacts and other locations –[www.sick.com](http://www.sick.com)