



i150-RP223

i150RP

SAFETY COMMAND DEVICES

SICK
Sensor Intelligence.



Ordering information

Type	Part no.
i150-RP223	6024884

Other models and accessories → www.sick.com/i150RP



Detailed technical data

Features

Positive action N/C contacts	2
N/O contacts	2
Actuation force (deflection)	125 N (300 mm)
Actuation frequency	≤ 3,600 /h
Actuation directions	1
Cord length	≤ 75 m

Safety-related parameters

B_{10d} parameter	2 x 10 ⁶ switching cycles (with small load)
Safe state in the event of a fault	The switch has no internal fault detection and is unable to assume a safe state in the event of a fault. Fault detection is performed by the connected safety-related logic unit.

Functions

Safe series connections	None, only individual wiring (with diagnostics)
--------------------------------	---

Interfaces

Connection type	Cable gland, 3 x M20
Conductor cross section	≤ 1.5 mm ²

Electrical data

Switching principle	Slow action switching element
Positive action N/C contacts	2
N/O contacts	2
Usage category	AC-15/DC-13 (IEC 60947-5-1)
Rated operating current (voltage)	3 A (240 V AC) 2 A (24 V DC)
Rated insulation voltage U_i	250 V
Rated impulse withstand voltage U_{imp}	2,500 V

Short-circuit protection	T6
Switching voltage	≥ 5 V DC
Switching current (switching voltage)	5 mA (5 V DC)

Mechanical data

Dimensions	69 mm x 203 mm x 85 mm
Weight	0.84 kg
Housing material	Die cast lightweight metal
Surface treatment	Varnished
Mechanical life	1 x 10 ⁶ switching cycles

Ambient data

Enclosure rating	IP65 (IEC 60529)
Ambient operating temperature	-25 °C ... +80 °C
Storage temperature	-25 °C ... +80 °C

Classifications

ECLASS 5.0	27270601
ECLASS 5.1.4	27270690
ECLASS 6.0	27270607
ECLASS 6.2	27270607
ECLASS 7.0	27270607
ECLASS 8.0	27270607
ECLASS 8.1	27270607
ECLASS 9.0	27270607
ECLASS 10.0	27270607
ECLASS 11.0	27270607
ECLASS 12.0	27270607
ETIM 5.0	EC002033
ETIM 6.0	EC002033
ETIM 7.0	EC002033
ETIM 8.0	EC002033
UNSPSC 16.0901	39121545

Dimensional drawing (Dimensions in mm (inch))

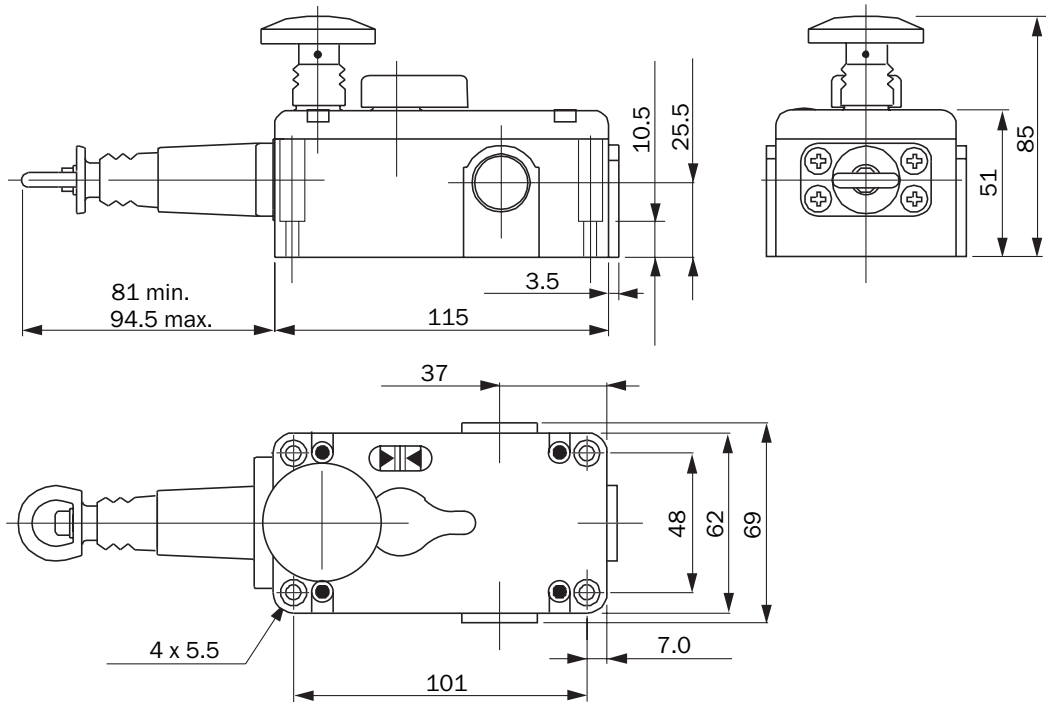

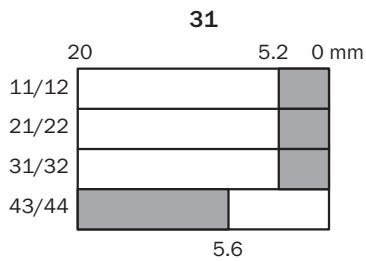
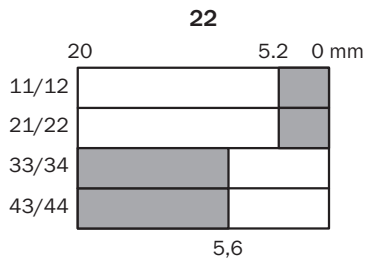

Actuator travel diagram

Contact action over the entire actuator withdrawal distance (full insertion = 0 mm)



- Contacts open
- Contacts closed

Switching elements

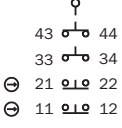
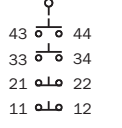
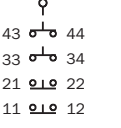
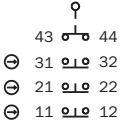
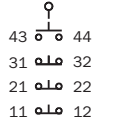
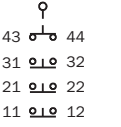
	Rope stack	Rope tensioned	Rope pulled
			
Switching element 22			
Switching element 31			

Switching element 22:

2 positive action N/C contacts + 2 N/O contact

Switching element 31:

3 positive action N/C contacts + 1 N/O contact

SICK AT A GLANCE

SICK is one of the leading manufacturers of intelligent sensors and sensor solutions for industrial applications. A unique range of products and services creates the perfect basis for controlling processes securely and efficiently, protecting individuals from accidents and preventing damage to the environment.

We have extensive experience in a wide range of industries and understand their processes and requirements. With intelligent sensors, we can deliver exactly what our customers need. In application centers in Europe, Asia and North America, system solutions are tested and optimized in accordance with customer specifications. All this makes us a reliable supplier and development partner.

Comprehensive services complete our offering: SICK LifeTime Services provide support throughout the machine life cycle and ensure safety and productivity.

For us, that is “Sensor Intelligence.”

WORLDWIDE PRESENCE:

Contacts and other locations –www.sick.com