

# Motion Terminal VTEM

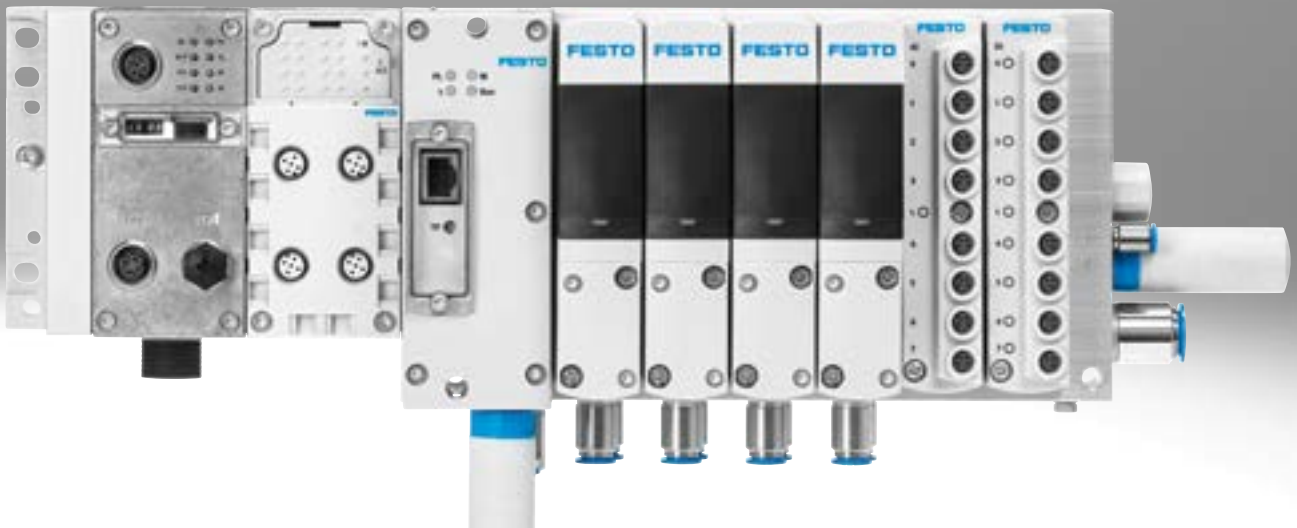

Festo Core Range  
Solves the majority of your automation tasks

With the Festo Core Range, we have selected the most important products and functions from our broad product catalogue, and added the quickest delivery.

Worldwide: Quickest delivery – wherever, whenever  
Simply good: Expected high Festo quality  
Fast: Easy and fast to select

The Core Range offers you the best value for your automation tasks.

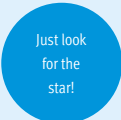

## Key features

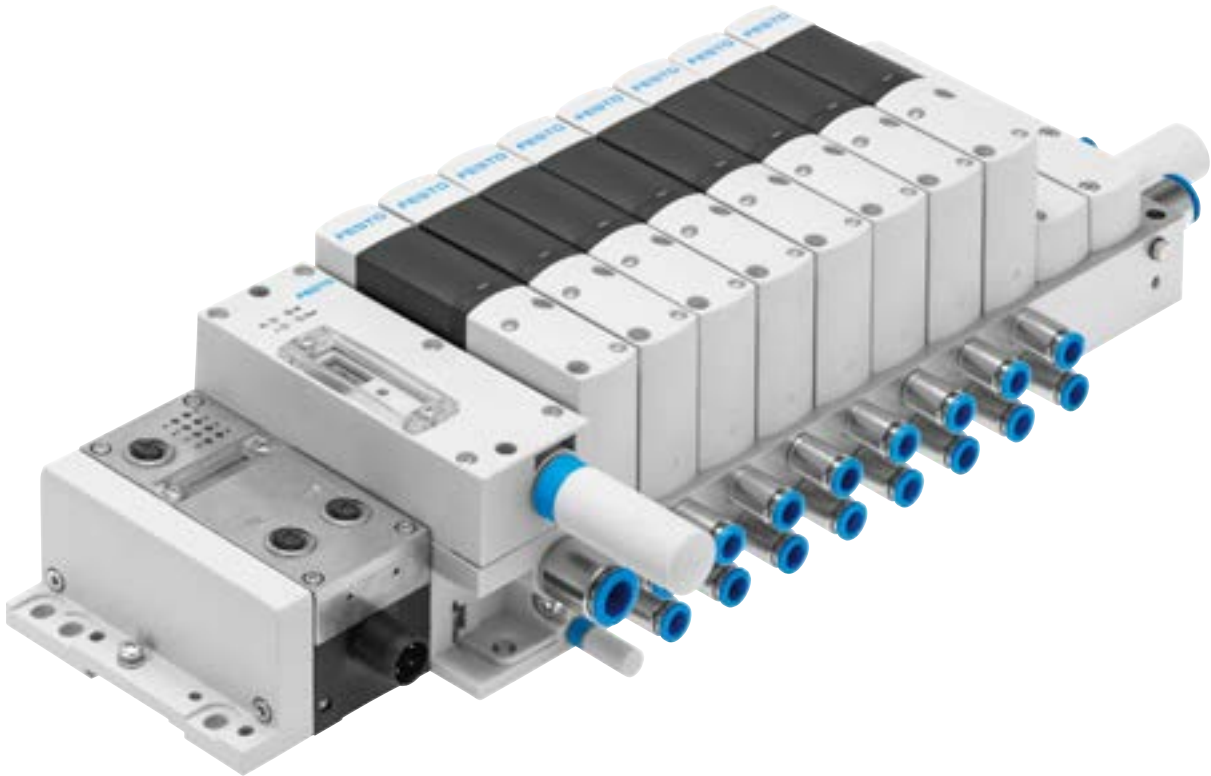

### Innovative

Benefits of piezo valves for pilot control:

- Pressure regulation function
- Very long service life
- Minimum energy requirement
- Low leakage when acting as a proportional pressure regulator

Integrated controller permits:

- Cyclical changes to the valve function
- Function integration via Motion Apps

### Flexible

The valves are connected and form a bridge circuit within the valve body; this enables a wide range of directional control valve functions to be realised at one valve position.

These functions are assigned to the valve by the controller and can be changed during operation.

The pressure regulator functionality of the valves together with the integrated pilot control enables the Motion Terminal VTEM to autonomously perform precision positioning tasks.

### Reliable

Integrated sensors monitor the switching status of the valves and the pressure in ports 1, 3, 2 and 4. The connected actuators can be monitored using optional input modules. This information is evaluated in the Motion Terminal VTEM itself and also transferred to a higher-order controller.

### Easy to install

- No need to change the valve, as the valve function is assigned using software
- Reduced storage space since only one valve is required for all functions
- Integrated mounting points for wall and H-rail mounting
- Integrated flow control functionality, no manual adjustment required
- Functions of 50 individual components integrated via Motion Apps

### Ordering data – Product options

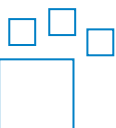

Configurable product  
This product and all its product options can be ordered using the configurator.

The configurator can be found at  
→ [www.festo.com/catalogue/...](http://www.festo.com/catalogue/...)  
Enter the part number or the type.

Part no. 8047502    Type VTEM

## Key features

### Flexibility

#### Motion Apps

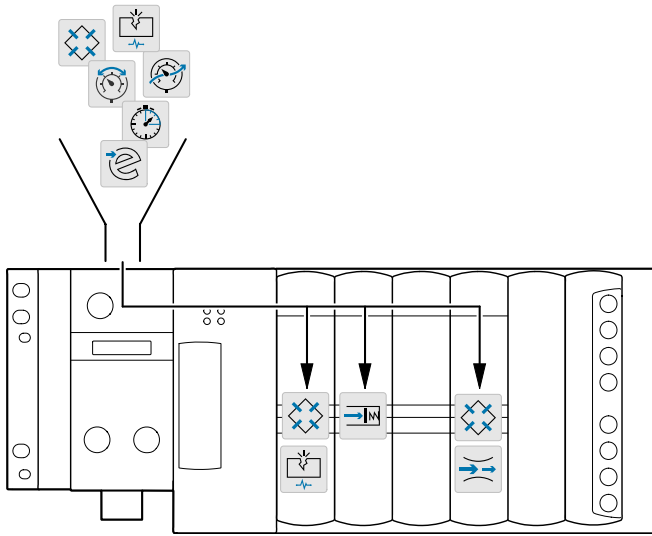

The Motion Terminal VTEM comprises four 2/2-way valves with piezo pilot control that form a bridge circuit and are monitored by sensors.

This creates a number of special features compared with a valve terminal that has conventional piston spool valves.

Depending on the actuation, the valves can perform the functions of a:

- 2x 2/2-way valve
- 2x 3/2-way valve
- 4/2-way valve
- 4/3-way valve
- Proportional pressure regulator
- Proportional directional control valve

Other functions that are usually associated with separate components, such as flow control or pressure regulation, can also be performed by the valves. Manual adjustment, procurement and maintenance are no longer needed as all tasks are assigned and controlled centrally via the software.

Which function a valve assumes and which tasks the controller can fulfil are determined by Motion Apps.

### Licences

The relevant licences must be obtained for each app of the Motion Terminal VTEM in order to be able to use it. The basic package includes the licences for certain Motion Apps. This can be extended at any time; however, it is not possible to transfer licences from one Motion Terminal VTEM to another.

The valve functions that are available within the Motion Terminal can be freely assigned to each individual valve wherever and whenever necessary.

All valve functions can be comprehensively monitored with the integrated sensors.

The controller of the Motion Terminal can use this information to perform more complex pressure regulation tasks or to switch connected actuators.

### Basic package (basic Motion Apps)



- Directional control valve functions
- Proportional directional control valve
- Supply and exhaust air flow control
- ECO drive
- Leakage diagnostics

These Motion Apps are a fundamental component of the Motion Terminal and included with every Motion Terminal.

The Motion Apps can be used at the same time on all valve positions of the Motion Terminal.

### Additional apps



- Proportional pressure regulation
- Presetting of travel time
- Selectable pressure level
- Flow control
- Soft Stop
- Positioning

To expand the basic package, other Motion Apps can be ordered individually for the Motion Terminal.

These Motion Apps must be ordered in the number required so they can be used simultaneously. Individual Motion Apps are subject to restrictions in terms of the number of instances in which they can be used simultaneously.

## Key features

### Integrated sensors

#### Monitoring functions

Integrated sensors monitor:

- Degree of opening of the valve (flow rate for supply air and exhaust air)
- Pressure

Monitoring is carried out:

- For each individual valve
- For each individual valve port

This generates the following diagnostic information:

- System leakage

#### Controlled movement

By adapting the pressure and flow rate, in combination with the integrated sensors, the cylinder movement can be controlled.

This means that a wide range of requirements can be met:

- Independent, proportional regulation of the supply and exhaust air for each cylinder chamber

- Soft start
- Fast start
- Noise reduction
- Reduced vibrations

- No need for exhaust air flow control valves
- No need for shock absorbers

### Energy efficiency

#### Energy-saving movement

Pressure at port 2

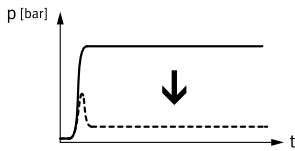

Movement with reduced force

Advantages:

- High energy efficiency, particularly energy-saving return stroke
- Reduced number of components

Principle:

Pressure is built up on the pressurisation side purely to create the differential pressure required to maintain movement (pre-exhausted). This means that less compressed air is needed for each cycle.

Application:

- Typically for fast running production machines (e.g. packaging, assembly or processing machines)
- Linear or rotary movement with a medium-sized stroke and/or high number of cycles

Pressure at port 4

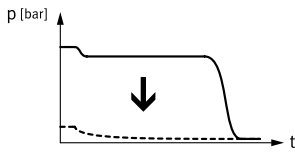

Objective:

Reduction in costs as less compressed air is needed than when the drive is fully pressurised. In turn, this reduces operating costs and improves overall economic efficiency.

At the end of the movement, the Motion Terminal VTEM closes the valve so that only the minimum static pressure sufficient to hold the cylinder in position is applied. If there is a pressure drop, the position is re-adjusted automatically thanks to monitoring by the sensors

#### Piezo technology

The Motion Terminal VTEM uses piezo technology, which is characterised by low energy consumption.

Advantages:

- Low-energy power supply units
- Small cable diameters
- Minimal self-heating

The degree of opening of the piezo valves can be freely controlled. This enables the flow rate through the valves to be controlled:

- Without additional components
- Time-controlled
- By sensors
- For each individual valve
- For each individual valve port





As the integrated pressure sensors of the Motion Terminal monitor the degree of opening of the valves, the pressure can be individually regulated:

- For each individual cylinder chamber
- For each individual valve
- For each individual valve port







Advantages:

- Lower air consumption thanks to partial pressurisation
- Variable contact pressure in the end position or when clamping a work-piece
- Variable independent pressure for forward/return stroke

## Product range overview

Function	Version	Type/code	Description	→ Page		
Pneumatic/ mechanical	<b>Pneumatic linking</b>	Fixed grid	VTEM	<ul style="list-style-type: none"> <li>• 2, 4 or 8 valve positions</li> <li>• 0 or 1 position for input modules for 2 valve positions</li> <li>• 0 or 2 positions for input modules for more than 2 valve positions</li> <li>• With electrical interface for terminal CPX</li> <li>• Supply/exhaust ports and working ports for the valves</li> <li>• Pilot air supply for the valves</li> <li>• Electrical actuation for the valves</li> </ul>	14	
	<b>Valve</b>	4x 2/2-way valve	VEVM	<ul style="list-style-type: none"> <li>• Default position if the power supply/signalling fails – all ports closed</li> <li>• Connected in series to form a bridge circuit</li> <li>• Proportional pilot control by piezo valves</li> <li>• Degree of valve opening monitored by sensor</li> <li>• Pressure sensors in ports 2 and 4</li> </ul>	19	
Electronics	<b>Input module</b>	Analogue	CTMM-A	<ul style="list-style-type: none"> <li>• 8 analogue inputs</li> <li>• M8, 4-pin</li> <li>• Exclusively for regulating the functions provided via the Motion Apps</li> <li>• Data can be transferred to a higher-order controller by the Motion Apps</li> </ul>	21	
		Digital	CTMM-D	<ul style="list-style-type: none"> <li>• 8 digital inputs</li> <li>• M8, 3-pin</li> <li>• Exclusively for controlling the functions provided via the Motion Apps</li> <li>• Data can be transferred to a higher-order controller by the Motion Apps</li> </ul>	21	
Motion Apps	<b>Basic Motion Apps</b>		Directional control valve functions	BMA	Valve type and switching status can be cyclically assigned to a: <ul style="list-style-type: none"> <li>• 2x 2/2-way valve, normally closed</li> <li>• 2x 3/2-way valve, normally open</li> <li>• 2x 3/2-way valve, normally closed</li> <li>• 2x 3/2-way valve, 1x normally closed, 1x normally open</li> <li>• 4/2-way valve, monostable</li> <li>• 4/2-way valve, bistable</li> <li>• 4/3-way valve, normally pressurised</li> <li>• 4/3-way valve, normally closed</li> <li>• 4/3-way valve, normally exhausted</li> </ul>	24
			Proportional directional control valve		Valve type, switching status and a continuous valve opening can be cyclically assigned to a: <ul style="list-style-type: none"> <li>• 4/3-way valve, normally closed</li> <li>• 2x 3/3-way valve, normally closed</li> </ul>	26
			Supply and exhaust air flow control		Flow control function: <ul style="list-style-type: none"> <li>• Supply air flow control</li> <li>• Exhaust air flow control</li> <li>• Comprises 4/4-way valve (corresponding to valve plus flow control)</li> </ul>	28
			ECO drive		For applications with low loads or slow travel movement: <ul style="list-style-type: none"> <li>• Energy-saving cylinder movement through supply air flow control</li> <li>• Adjustable supply air flow control value</li> <li>• Blocks the supply air on reaching the end position</li> <li>• Sensors and digital input module required</li> </ul>	29
			Leakage diagnostics		Air consumption monitoring: <ul style="list-style-type: none"> <li>• Teaching the system</li> <li>• Diagnostic message using specified parameters</li> </ul>	34
These Motion Apps can be used at the same time on all valve positions of the Motion Terminal.						

Product range overview

Function	Version	Type/code	Description	→ Page	
Motion Apps	<b>Additional apps</b>				
		Proportional pressure regulation	PD	Regulation of the two valve output pressures independently of one another: <ul style="list-style-type: none"> <li>• 2x proportional pressure regulator</li> </ul>	27
		Presetting of travel time	TT	Presetting the travel time for retracting and advancing: <ul style="list-style-type: none"> <li>• Pre-calculation of the travel profile using set parameters</li> <li>• Teaching the system</li> <li>• Automatic readjustment of the system</li> <li>• Sensors and digital input module required</li> </ul>	30
		Selectable pressure level	SPL	Energy-saving cylinder movement using a reduced pressure level: <ul style="list-style-type: none"> <li>• Pressure regulation for supply air</li> <li>• Flow control function for exhaust air</li> </ul>	31
		Flow control	FC	Regulation of the volumetric flow rates at the two valve outputs independently of one another: <ul style="list-style-type: none"> <li>• Open-loop and closed-loop operation possible</li> <li>• Control characteristics can be adjusted</li> <li>• Different media can be set</li> <li>• Sensors and analogue input module required for closed-loop operation</li> </ul>	32
		Soft Stop	SP	Control of cylinder behaviour near the end positions: <ul style="list-style-type: none"> <li>• Controlled acceleration</li> <li>• Gentle braking</li> <li>• Teaching the system</li> <li>• Automatic readjustment of the system</li> <li>• Sensors and analogue input module required</li> </ul>	33
	Positioning	BB	Free positioning across the movement range: <ul style="list-style-type: none"> <li>• Controlled motion profile can be configured using parameters (e.g. high dynamism)</li> <li>• Energy-saving cylinder movement possible by lowering the pressure level via parameterisation</li> <li>• Stable in response to changes caused by wear</li> <li>• Teaching the system</li> <li>• Sensors and analogue input module required</li> </ul>	35	
For these Motion Apps, licences are required for the number of simultaneous usages					

Peripherals overview

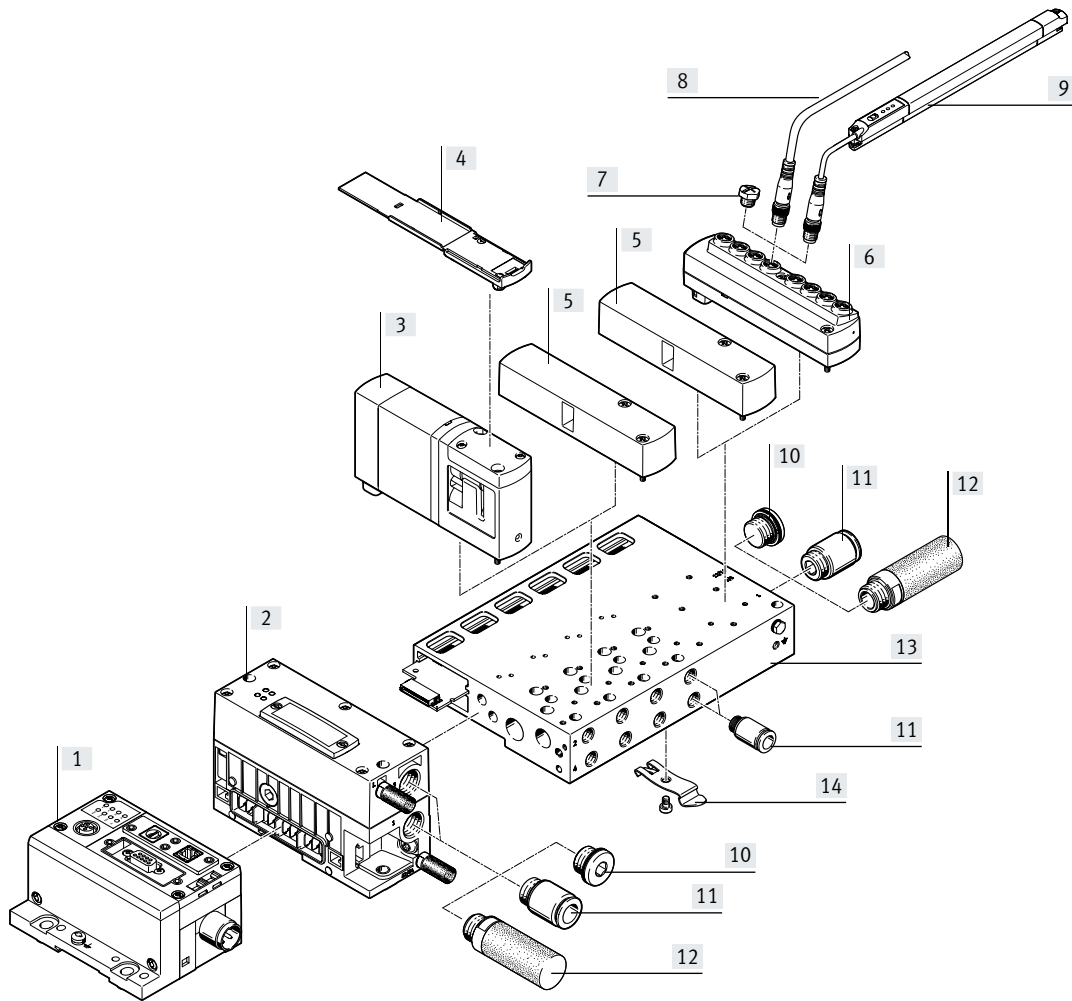

Designation		Brief description	→ Page/Internet	
[1]	CPX modules	CPX	Bus node, control block, input and output modules	cpx
[2]	Controller	CTMM	For VTEM and pneumatic interface to the terminal CPX	14
[3]	Valve body	VEVM	Contains 4 interconnected poppet valves with piezo pilot control	19
[4]	Inscription label holder	ASCF	For one valve	36
[5]	Cover plate	VABB	For unoccupied valve position (vacant position) or input module position	36
[6]	Input module	CTMM	For connecting sensors to the VTEM	21
[7]	Cover cap	ISK	For sealing ports that are not required	36
[8]	Connecting cable	NEBU	For connecting sensors	38
[9]	Position sensor	SDAP	Analogue displacement sensor for VTEM input module CTMM	36
[10]	Blanking plug	B	For sealing ports that are not required	38
[11]	Fittings	QS	For connecting compressed air tubing	38
[12]	Silencer	U	For exhaust ports	38
[13]	Manifold rail	VABM	For pneumatic and electrical connections	36
[14]	H-rail mounting	VAME	For CPX and VTEM	36

Peripherals overview

Connecting the Motion Terminal VTEM to a higher-order controller

Overview

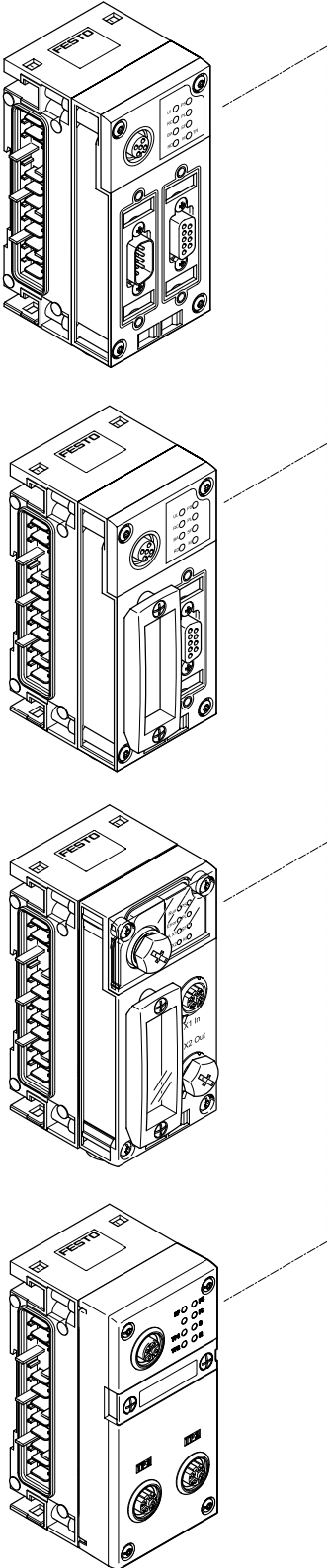

The precise technical data and specifications for CPX can be found online at:  
 → Internet: [cpx](http://cpx)

Bus protocol/bus node	Special features
<b>CODESYS</b>	
CPX-CEC-C1-V3 CPX-CEC-S1-V3 CPX-CEC-M1-V3	<ul style="list-style-type: none"> <li>• Programming with CODESYS</li> <li>• Ethernet interface</li> <li>• Modbus/TCP</li> <li>• EasyIP</li> <li>• CANopen master</li> <li>• Up to 512 digital inputs/outputs</li> <li>• 32 analogue inputs</li> <li>• 18 analogue outputs</li> </ul>
<b>DeviceNet</b>	
CPX-FB11	<ul style="list-style-type: none"> <li>• Up to 512 digital inputs/outputs</li> <li>• 18 analogue inputs/outputs</li> </ul>
<b>PROFIBUS DP</b>	
CPX-FB13	<ul style="list-style-type: none"> <li>• Up to 512 digital inputs/outputs</li> <li>• 32 analogue inputs</li> <li>• 18 analogue outputs</li> </ul>
<b>CC-Link</b>	
CPX-FB23-24	<ul style="list-style-type: none"> <li>• Up to 512 digital inputs/outputs</li> <li>• 32 analogue inputs/outputs</li> </ul>
<b>PROFINET</b>	
CPX-FB43 CPX-M-FB44	<ul style="list-style-type: none"> <li>• Up to 512 digital inputs/outputs</li> <li>• 32 analogue inputs</li> <li>• 18 analogue outputs</li> </ul>
<b>EtherNet/IP</b>	
CPX-FB36	<ul style="list-style-type: none"> <li>• Up to 512 digital inputs/outputs</li> <li>• 32 analogue inputs</li> <li>• 18 analogue outputs</li> </ul>
<b>EtherCAT</b>	
CPX-FB37	<ul style="list-style-type: none"> <li>• Up to 512 digital inputs/outputs</li> <li>• 32 analogue inputs</li> <li>• 18 analogue outputs</li> </ul>
<b>Sercos III</b>	
CPX-FB39	<ul style="list-style-type: none"> <li>• Up to 512 digital inputs/outputs</li> <li>• 32 analogue inputs/outputs</li> </ul>
<b>POWERLINK</b>	
CPX-FB40	<ul style="list-style-type: none"> <li>• Up to 512 digital inputs/outputs</li> <li>• 32 analogue inputs/outputs</li> </ul>



## Key features – Pneumatic components

### Pneumatics of the Motion Terminal

The Motion Terminal VTEM is operated exclusively with the electric terminal CPX. A Motion Terminal VTEM comprises 2, 4 or 8 valve positions.

The pneumatic and electrical connections are in a fixed grid. Subsequent extension is not possible.

One or two positions for input modules with 8 digital or 8 analogue inputs can be integrated into the Motion Terminal.

### Sub-base valve

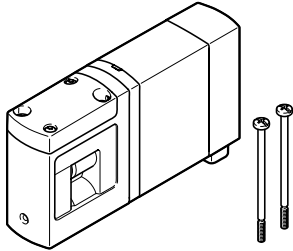

VTEM offers a comprehensive range of programmable valve functions. The valves comprise four 2/2-way proportional valves connected to form a bridge circuit. Each 2/2-way proportional valve is pilot controlled by two piezo valves.

The pilot air for all valves is supplied jointly via port 14 (branched internally from port 1 or supplied externally).

Sensors monitor the degree of opening of the valves as well as the pressure in ports 2 and 4.

### 4x 2/2-way proportional valve

Circuit symbol

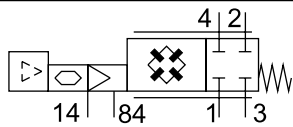

Code

Position function 1-8: C

Description

- Bridge circuit
- Monostable
- Reset via mechanical spring
- Operating pressure 0 ... 8 bar
- Vacuum operation at port 3 only

### Cover plate

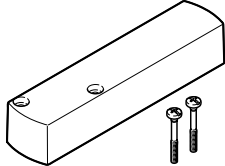

Vacant position (code L) without valve function, for reserving valve positions or unused input module positions (seal).

### Compressed air supply and exhaust

The Motion Terminal is supplied with compressed air via:

- Manifold rail
- Controller/pneumatic interface

Exhausting (port 3) takes place via:

- Manifold rail
- Controller/pneumatic interface

The pilot air exhaust (port 84) is completely separate from port 3. The connection is on the controller (pneumatic interface to CPX terminal) together with the connections for port 1 and 3.

The pressure at port 1 is monitored to ensure operation. If the pressure is below 3 bar or above 10 bar, any applications in progress are stopped and an error message is output.

All valves on the Motion Terminal have a common pilot air supply.

They can be supplied as follows:

- Internal (from port 1 of the manifold rail) or
- External (from port 14)

Pressure zone separation (duct 1) is not required, as each valve can control the output pressure separately.

For vacuum applications, a vacuum is connected to port 3 and pressure for the ejector pulse is connected to port 1.



#### Note

A filter must be installed upstream of valves operated in vacuum mode. This prevents any foreign matter in the intake air getting into the valve (e.g. when operating a suction cup with connector).

Key features – Pneumatic components

Fluid power supply and pilot air supply		Fluid power supply and pilot air supply	
Illustration	Description	Illustration	Description
<b>Controller</b>			
	<ul style="list-style-type: none"> <li>Exhausting via the controller</li> <li>Compressed air is supplied via the manifold rail</li> <li>Exhausting can also take place via the manifold rail</li> </ul>		<ul style="list-style-type: none"> <li>Compressed air supply via the controller</li> <li>Exhausting takes place via the manifold rail</li> <li>Compressed air can also be supplied via the manifold rail</li> </ul>
	<ul style="list-style-type: none"> <li>Exhaust and compressed air supply via the controller</li> <li>Compressed air supply and exhaust also possible via the manifold rail</li> </ul>		<ul style="list-style-type: none"> <li>Connections on the controller sealed</li> <li>Compressed air supply and exhaust via the manifold rail</li> </ul>
<b>Manifold rail with internal pilot air supply</b>			
	<ul style="list-style-type: none"> <li>Exhausting via the manifold rail</li> <li>Compressed air supply via the controller</li> <li>Exhausting can also take place via the controller</li> </ul>		<ul style="list-style-type: none"> <li>Compressed air supply via the manifold rail</li> <li>Exhausting takes place via the controller</li> <li>Compressed air can also be supplied via the controller</li> </ul>
	<ul style="list-style-type: none"> <li>Exhaust and compressed air supply via the manifold rail</li> <li>Compressed air supply and exhaust also possible via the controller</li> </ul>		<ul style="list-style-type: none"> <li>Connections on the manifold rail sealed</li> <li>Compressed air supply and exhaust via the controller</li> </ul>
<b>Manifold rail with external pilot air supply</b>			
	<ul style="list-style-type: none"> <li>Exhausting via the manifold rail</li> <li>Compressed air supply via the controller</li> <li>Exhausting can also take place via the controller</li> </ul>		<ul style="list-style-type: none"> <li>Compressed air supply via the manifold rail</li> <li>Exhausting takes place via the controller</li> <li>Compressed air can also be supplied via the controller</li> </ul>
	<ul style="list-style-type: none"> <li>Exhaust and compressed air supply via the manifold rail</li> <li>Compressed air supply and exhaust also possible via the controller</li> </ul>		<ul style="list-style-type: none"> <li>Connections on the manifold rail sealed</li> <li>Compressed air supply and exhaust via the controller</li> </ul>

## Key features – Pneumatic components

### vacuum operation

#### Basics

The Motion Terminal VTEM can be operated with vacuum. In this case, the vacuum is connected to port 3. Pressure for an ejector pulse can be connected at port 1.

When using internal pilot air supply, the necessary minimum pressure (3 bar) at port 1 must be maintained.

Internal pressure sensors in port 2 and port 4 detect the pressure/vacuum and enable the degree of opening and the pressure level of the valve to be controlled. The sensors are designed so they are protected against contamination.

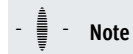

#### Note

A filter must be installed upstream of valves operated in vacuum mode. This prevents any foreign matter in the intake air getting into the valve (e.g. when operating a suction cup with connector).

### Fittings

Ports 1, 2, 3, 4, 14 and 84

The outlet direction of the pneumatic connections in the manifold rail is specified.

The outlet direction of the connected tubing can be varied widely by choosing appropriate fittings.

The connection type and outlet direction are selected:

- For all ports 2 and 4
- For all compressed air supply connections
- For all exhaust connections

- For each individual port 2, as a deviation from the general specification
- For each individual port 4, as a deviation from the general specification

Connection on the valve (port 2/4)

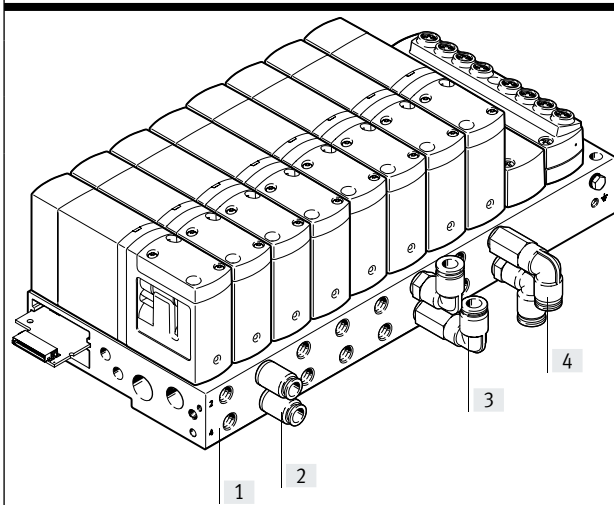

	Code	Description
[1]	G18	Threaded connection G1/8
[2]	Q...	Valve connection: push-in connector ... Valve connection type: straight
[3]	Q... FA	Valve connection: push-in connector ... Valve connection type: angled upwards
[4]	Q... FC	Valve connection: push-in connector ... Valve connection type: angled downwards

## Key features – Mounting

### Mounting the Motion Terminal

#### Wall mounting

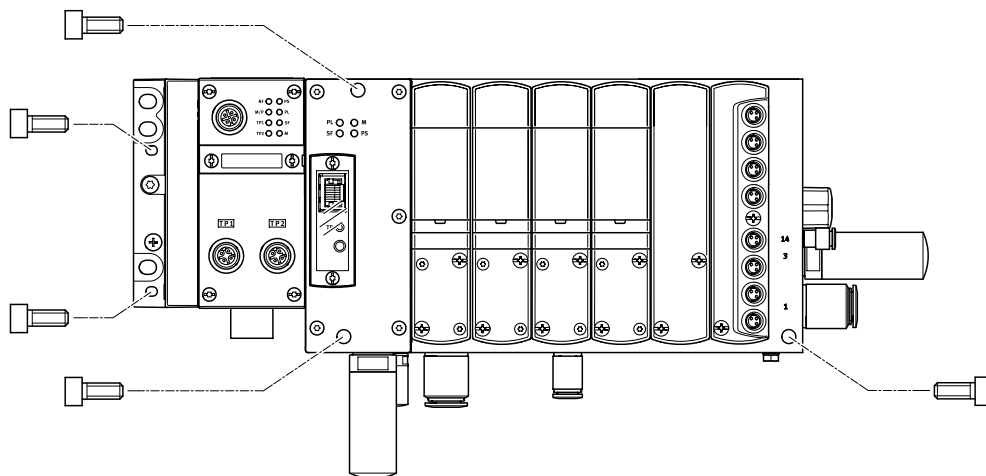

The Motion Terminal VTEM is screwed to the mounting surface using five M4 or M6 screws.

The mounting holes are located:

- On the left end plate (CPX)
- On the right side of the manifold rail
- On the VTEM controller

#### H-rail mounting

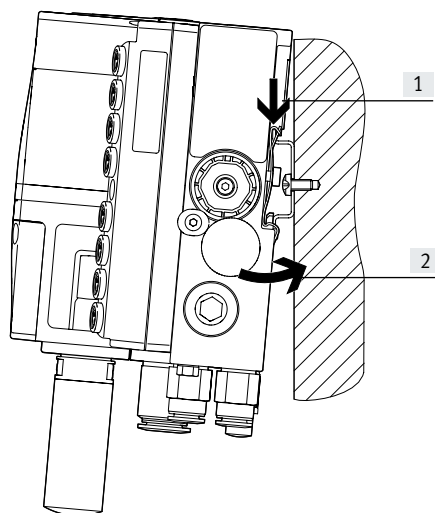

- [1] The Motion Terminal is hooked onto the H-rail.
- [2] The Motion Terminal is then pivoted onto the H-rail and latched in place

## Key features – Display and operation

### Display and operation

#### CPX terminal

The modules of the CPX terminal have a row of LEDs. These provide information about:

- Status of bus communication
- System status
- Module status

#### VTEM controller

The VTEM controller has LEDs for displaying:

- Operating voltages
- Status of communication to the higher-order controller
- Ethernet data traffic

#### VTEM valve

Each VTEM valve has an indicator which indicates whether the valve is ready for operation or whether there is a malfunction.

The valves do not have a mechanical manual override.

#### VTEM input module

The input modules are equipped with one central ready status indicator per module.

The digital input module displays the input status for each port.

### Display and operating components

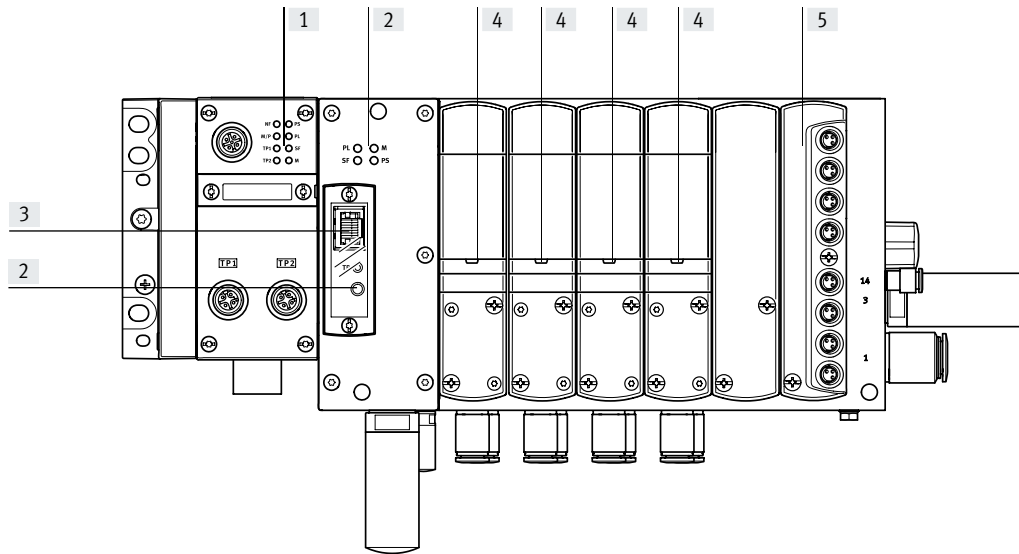

- [1] LED indicators on the bus node of the CPX terminal
- [2] LED indicators on the VTEM controller
- [3] Ethernet interface on the VTEM controller
- [4] LED indicator on the VTEM valve
- [5] VTEM input module

### Diagnostics

Detailed diagnostic functions are needed in order to quickly locate the causes of errors in the electrical installation and therefore reduce downtimes in the production plant.

A basic distinction is made between on-the-spot diagnostics using LEDs or an operator unit and diagnostics using a bus interface.

The Motion Terminal VTEM supports on-the-spot diagnostics using LEDs as well as diagnostics via the bus interface and Ethernet interface.

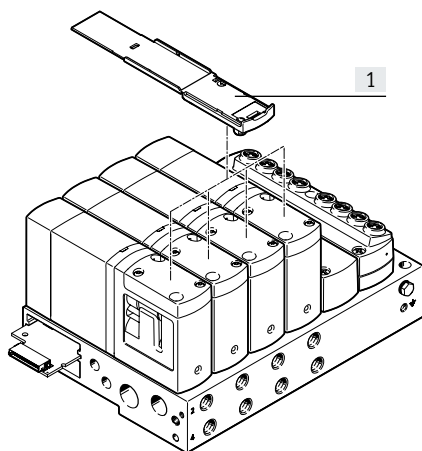

### Labelling



- [1] Inscription label holder

Inscription label holders are available for labelling the Motion Terminal. These are clipped onto the valves.

## Datasheet – Motion Terminal VTEM

-  - Flow rate  
up to 450 l/min
-  - Valve width  
27 mm
-  - Voltage  
24 V DC



### General technical data

Valve terminal design	Fixed grid
Motion Apps	Directional control valve functions
	Proportional directional control valve
	Proportional pressure regulation
	Supply and exhaust air flow control
	ECO drive
	Presetting of travel time
	Selectable pressure level
	Flow control
	Leakage diagnostics
	Soft Stop
Positioning	
Maximum number of valve positions	8
Valve size [mm]	27
Grid dimension [mm]	28
Nominal size [mm]	4.2
Design	Piston seat
Sealing principle	Soft
Actuation type	Electrical
Type of control	Piloted
Valve function	To be assigned via Motion App
Standard flow rate 0.8 → 0 MPa (8 → 0 bar, 116 → 0 psi) [l/min]	1000
Standard nominal flow rate 0.6 → 0.5 MPa (6 → 5 bar, Pressurisation [l/min]	450
87 → 72.5 psi) Exhaust [l/min]	480
Suitable for vacuum	Yes
Exhaust air function	Cannot be throttled
Pilot air supply	Internal or external
Flow direction	Not reversible
Electric I/O system	Yes
Degree of protection	IP65

## Datasheet – Motion Terminal VTEM

Operating and environmental conditions		
Operating medium		Compressed air to ISO 8573-1:2010 [7:4:4] Inert gases
Pilot medium		Compressed air to ISO 8573-1:2010 [7:4:4] Inert gases
Note on the operating/pilot medium		Lubricated operation not possible Condensation in the valve not allowed
Operating pressure	[MPa]	0.3 ... 0.8
	[bar]	3 ... 8
	[psi]	43.5 ... 116
Pilot pressure	[MPa]	0.3 ... 0.8
	[bar]	3 ... 8
	[psi]	43.5 ... 116
Note on operating/pilot pressure		0 ... 8 bar with external pilot air Vacuum operation at port 3 only
Ambient temperature	[°C]	+5 ... +50
Temperature of medium	[°C]	+5 ... +50
Storage temperature	[°C]	-20 ... +40
Relative humidity	[%]	0 ... 90
Corrosion resistance class CRC <sup>1)</sup>		2
CE marking (see declaration of conformity)		To EU EMC Directive <sup>2)</sup>
KC marking		KC EMC
LABS (PWIS) conformity		VDMA24364 zone III
Certification		c UL us - Listed (OL)
Material fire test		UL94 HB
Certificate-issuing authority		UL E322346
Food-safe		See supplementary material information
Vibration resistance		Transport application test with severity level 2 to FN 942017-4 and EN 60068-2-6
Shock resistance		Shock test with severity level 2 to FN 942017-5 and EN 60068-2-27
Note on shock resistance		Only static installation permitted when mounting with H-rail.

1) More information [www.festo.com/x/topic/kbk](http://www.festo.com/x/topic/kbk)

2) For information about the area of use, see the EC declaration of conformity at: [www.festo.com/catalogue/VTEM](http://www.festo.com/catalogue/VTEM) → Support/Downloads.

If the devices are subject to usage restrictions in residential, commercial or light-industrial environments, further measures for the reduction of the emitted interference may be necessary.

## Electrical data

Nominal operating voltage	[V DC]	24
Permissible voltage fluctuations	[%]	±25
Protection against direct and indirect contact		PELV

## Current consumption/power

			Controller	Valve	Digital input module	Analogue input module
Intrinsic current consumption	At nominal operating voltage, electronics/sensors	[mA]	115	60	12	12
	At nominal operating voltage, load	[mA]	85	24	0	0
Power	At nominal operating voltage, electronics/sensors	[W]	2.76	1.5	0.29	0.29
	At nominal operating voltage, load	[W]	2.04	0.58	0	0

## Datasheet – Motion Terminal VTEM

Pneumatic connections		
Supply	1	G3/8 thread
Exhaust port	3	G3/8 thread
Pilot air supply	14	M5 thread
Pilot exhaust air	84	M7 thread
Venting hole		M7 thread
Working ports	2	G1/8 thread
	4	G1/8 thread

Materials	
Seals	TPE-U(PU)
	NBR
Note on materials	RoHS-compliant

Product weight	Approx. weight [g]
Controller	290
Manifold rail, 2 valve positions	550
	780 (with 1 vacant position for input module)
Manifold rail, 4 valve positions	990
	1460 (with 2 vacant positions for input modules)
Manifold rail, 8 valve positions	1875
	2340 (with 2 vacant positions for input modules)
Cover plate	75
Valve body	200
Input module	75

### Connection and display components

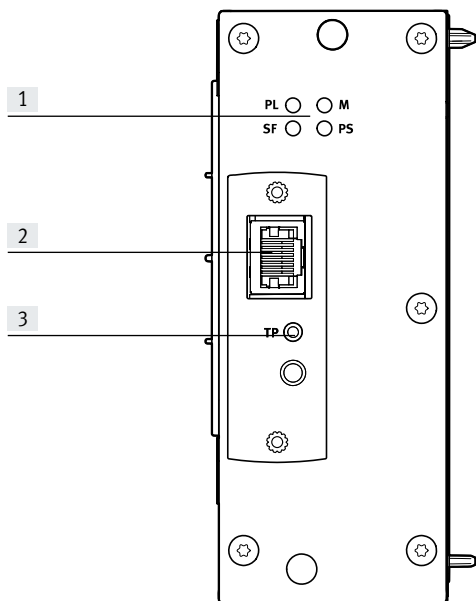

- [1] Diagnostics LED
- [2] Ethernet interface for system configuration
- [3] Status LED for Ethernet interface



Datasheet – Motion Terminal VTEM

Download CAD data → [www.festo.com](http://www.festo.com)

Dimensions

Front view

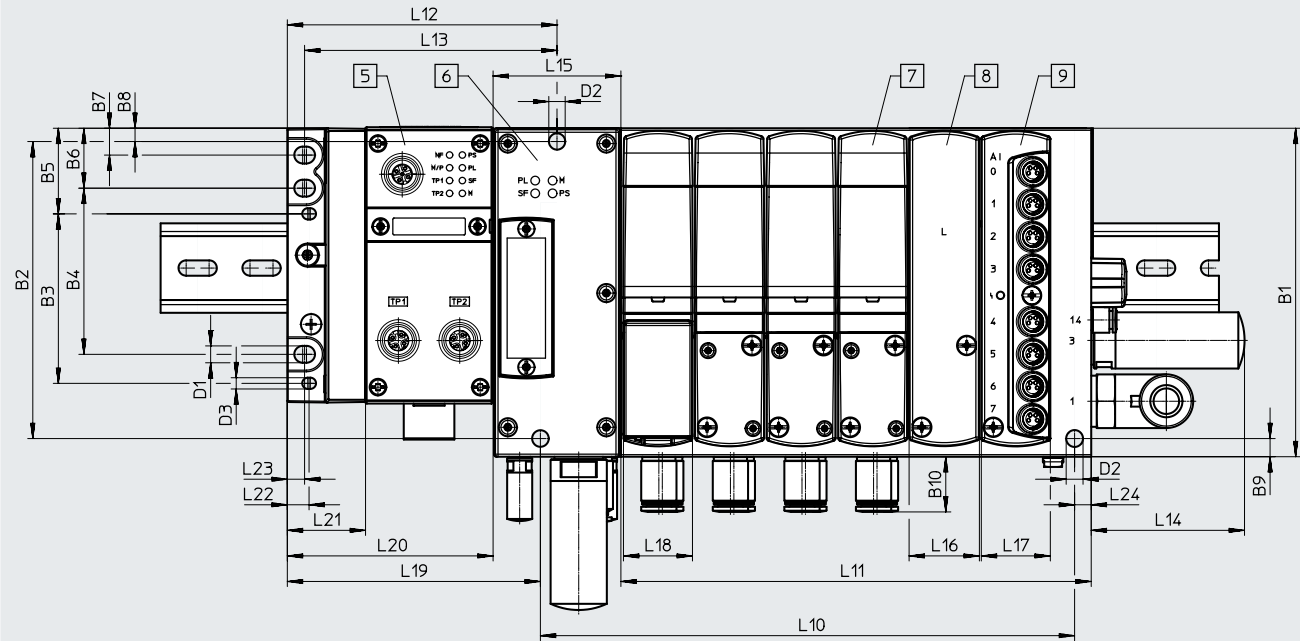

- [5] Bus node CPX
- [6] Controller
- [7] Valve VEVM
- [8] Cover plate
- [9] Input module CTMM

Type	B1	B2	B3	B4	B5	B6	B7	B8	B9	B10	D1	D2	D3
VTEM	128.5	116.2	66.3	65	33.5	23.5	10.5	5.2	7.1	21.6	6.6	6.6	4.4

Type	Number of valve positions	Number of input modules	L10	L11	L12	L13	L14	L15	L16	L17	L18	L19
VTEM	2	0	97	72	105.5	98.8	60	50	27.5	27	27	99
	2	1	125	100								
	4	0	153	128								
	4	2	209	184								
	8	0	265	240								
	8	2	321	296								

Type	L20	L21	L22	L23	L24
VTEM	80.5	30.6	8.5	6.8	6.5

Datasheet – Motion Terminal VTEM

Dimensions

Download CAD data → [www.festo.com](http://www.festo.com)

Horizontal view

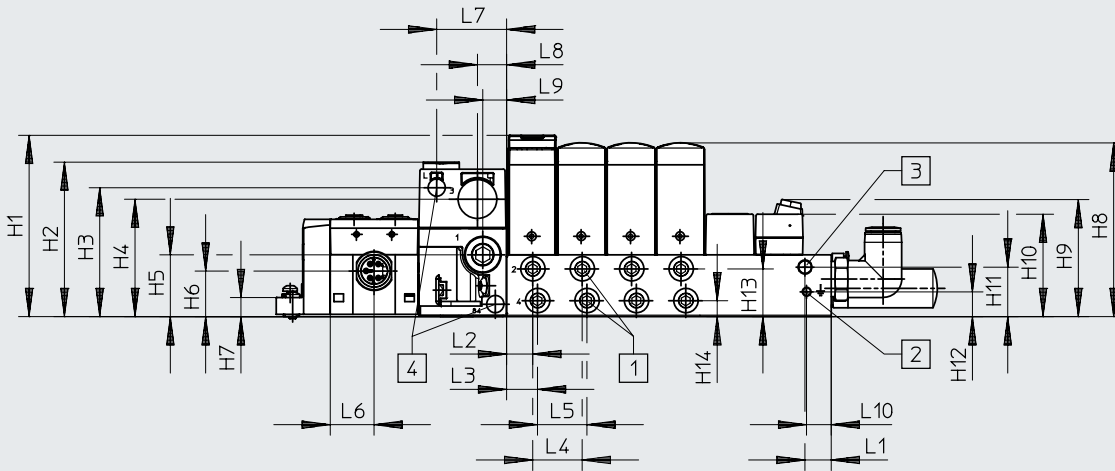

- [1] Port 2 and 4
- [2] Earth terminal
- [3] Port 14, external pilot air supply
- [4] Port L and 84

Type	H1	H2	H3	H4	H5	H6	H7	H8	H9	H10	H11	H12	H13	H14
VTEM	102.7	87.5	73	66.5	35	25.8	10.8	98.4	66.3	58	28	17	27	9

Type	L1	L2	L3	L4	L5	L6	L7	L8	L9	L10
VTEM	14.9	14.9	17.6	28	28	24.9	39.6	16.5	13.5	14

Side view

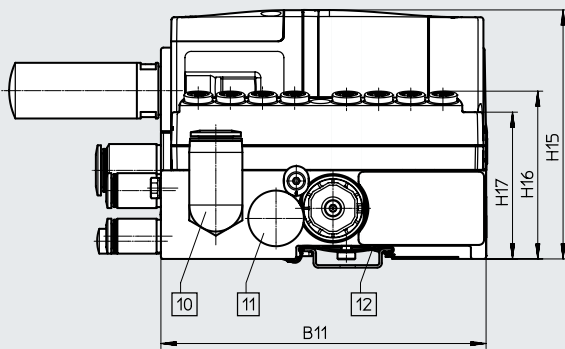

- [10] Port 1
- [11] Port 3
- [12] H-rail mounting

Type	B11	H15	H16	H17
VTEM	128.5	98.4	66.3	58

## Datasheet – Valves VEVM

-  - Flow rate  
450 l/min

-  - Valve width  
27 mm

-  - Voltage  
24 V DC

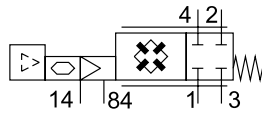
**General technical data**

Valve function	To be assigned via Motion App		
Reset method	Mechanical spring		
Design	Piston seat		
Sealing principle	Soft		
Actuation type	Electrical		
Type of control	Piloted		
Pilot air supply	External		
Flow direction	Not reversible		
Suitable for vacuum	Yes		
Exhaust air function	Cannot be throttled		
Mounting position	Any		
Status indication	Blue LED = normal status Red LED = malfunction		
Nominal size	[mm]	4.2	
Standard flow rate 0.8 → 0 MPa (8 → 0 bar, 116 → 0 psi)	[l/min]	1000	
Standard nominal flow rate 0.6 → 0.5 MPa (6 → 5 bar, 87 → 72.5 psi)	Pressurisation	[l/min]	450
	Exhaust	[l/min]	480
C value	[l/sbar]	2	
Valve size	[mm]	27	
Grid dimension	[mm]	28	
Product weight	[g]	200	
Degree of protection	IP65		

**Switching times**

Response time	On	[ms]	8.5
	off	[ms]	8.5

## Datasheet – Valves VEVM

Operating and environmental conditions		
Operating medium		Compressed air to ISO 8573-1:2010 [7:4:4] Inert gases
Pilot medium		Compressed air to ISO 8573-1:2010 [7:4:4] Inert gases
Note on the operating/pilot medium		Lubricated operation not possible Condensation in the valve not allowed
Operating pressure	[MPa]	0.3 ... 0.8
	[bar]	3 ... 8
	[psi]	43.5 ... 116
Pilot pressure	[MPa]	0.3 ... 0.8
	[bar]	3 ... 8
	[psi]	43.5 ... 116
Note on operating/pilot pressure		0 ... 8 bar for external pilot air supply Vacuum operation at port 3 only
Ambient temperature	[°C]	+5 ... +50
Temperature of medium	[°C]	+5 ... +50
Storage temperature	[°C]	-20 ... +40
Relative humidity	[%]	0 ... 90
Corrosion resistance class CRC <sup>1)</sup>		2
LABS (PWIS) conformity		VDMA24364 zone III
Material fire test		UL94 HB
Food-safe		See supplementary material information

1) More information [www.festo.com/x/topic/kbk](http://www.festo.com/x/topic/kbk)

Electrical data		
Nominal operating voltage	[V DC]	24
Permissible voltage fluctuations	[%]	±25
Electrical power consumption	[W]	1.5
Duty cycle	[%]	100

Pneumatic connections		
Supply	1	G3/8 thread
Exhaust port	3	G3/8 thread
Pilot air supply	14	M5 thread
Pilot exhaust air	84	M7 thread
Venting hole		M7 thread
Working ports	2	G1/8 thread
	4	G1/8 thread

Materials	
Housing	PA
Seals	TPE-U(PU)
	NBR
Note on materials	RoHS-compliant

## Datasheet – Input modules

### Function

Input modules enable analogue and digital sensors to be connected to the Motion Terminal.

The input signals are used for motion tasks, but can also be looped through from a Motion App to the higher-order controller.

### Area of application

- Input modules for 24 V DC sensor supply voltage
- Digital module with PNP logic
- Analogue module for 4 ... 20 mA



General technical data		Digital input module	Analogue input module
Electrical connection	Function	Digital input	Analogue input
	Connection type	8x socket	8x socket
	Connection technology	M8x1, A-coded to EN 61076-2-104	M8x1, A-coded to EN 61076-2-104
	Number of pins/wires	3	4
Number of inputs		8	8
Number of outputs		0	0
Input characteristics		To IEC 61131-2, type 3	–
Analogue input		–	4 ... 20 mA
Switching level		Signal 0: ≤ 5 V	–
		Signal 1: ≥ 11 V	–
Input debounce time	[ms]	0.1	–
Switching logic at inputs		PNP (positive switching)	–
Measured variable		–	Current
Electrical protection		Internal electronic fuse	Internal electronic fuse
Electrical isolation	Channel – internal bus	No	No
	Channel – channel	No	No
Diagnostics via LED		Errors per module	Errors per module
		Status per channel	–
Nominal operating voltage	[V DC]	24	
Nominal operating voltage, electronics/sensors	[V DC]	24	
Permissible voltage fluctuations	[%]	±25	
Intrinsic current consumption at nominal operating voltage	[mA]	Typically 12	
Max. total current of inputs per module	[A]	0.2	
Max. cable length	[m]	30	
Dimensions	W x L x H	[mm]	27 x 123 x 40
Grid dimension		[mm]	28
Product weight		[g]	75
Degree of protection		IP65	
		IP67	

### Materials

Housing	Reinforced PA
Note on materials	RoHS-compliant

### Operating and environmental conditions

Ambient temperature	[°C]	–5 ... +50
Temperature of medium	[°C]	–5 ... +50
Storage temperature	[°C]	–20 ... +40
Corrosion resistance class CRC <sup>1)</sup>		2
CE marking (see declaration of conformity)		To EU EMC Directive <sup>2)</sup>
LABS (PWIS) conformity		VDMA24364-B1/B2-L

1) More information [www.festo.com/x/topic/kbk](http://www.festo.com/x/topic/kbk)

2) For information about the area of use, see the EC declaration of conformity at: [www.festo.com/catalogue/VTEM](http://www.festo.com/catalogue/VTEM) → Support/Downloads.

If the devices are subject to usage restrictions in residential, commercial or light-industrial environments, further measures for the reduction of the emitted interference may be necessary.

## Datasheet – Input modules

Safety data	
CE marking (see declaration of conformity)	To EU EMC Directive <sup>1)</sup>
Shock resistance	Shock test with severity level 2 to FN 942017-5 and EN 60068-2-27
Vibration resistance	Transport application test with severity level 2 to FN 942017-4 and EN 60068-2-6

1) For information about the area of use, see the EC declaration of conformity at: [www.festo.com/catalogue/VTEM](http://www.festo.com/catalogue/VTEM) → Support/Downloads.  
 If the devices are subject to usage restrictions in residential, commercial or light-industrial environments, further measures for the reduction of the emitted interference may be necessary.

### Connection and display components

#### Input module with digital inputs

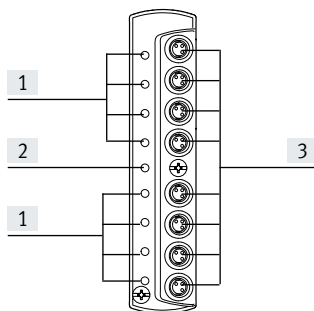

- [1] Status LEDs for inputs (status indication, green)
- [2] Status LED (module) for short circuit/overload of sensor supply (red)
- [3] Sensor connections

#### Input module with analogue inputs

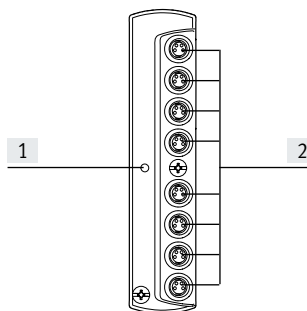



- [1] Status LED (module) for short circuit/overload of sensor supply (red)
- [2] Sensor connections

### Pin allocation for sensor connections

Terminal allocation	Pin	Signal	Designation	Terminal allocation	Pin	Signal	Designation
<b>Input module with digital inputs</b>				<b>Input module with analogue inputs</b>			
	1	24 V	Operating voltage 24 V		1	24 V	Operating voltage 24 V
	3	0 V	Operating voltage 0 V		2	Ix*	Sensor signal
	4	Ix*	Sensor signal		3	0 V	Operating voltage 0 V
					4	n.c	Not connected

\* Ix = Input x

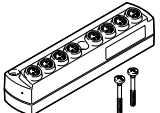
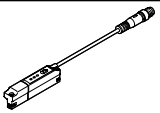
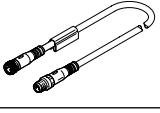
## Datasheet – Input modules

Ordering data				Part no.	Type
<b>Input module</b>					
	Module with 8 inputs	Digital inputs	<b>8047505</b>	<b>CTMM-S1-D-8E-M8-3</b>	
		Analogue inputs	<b>8047506</b>	<b>CTMM-S1-A-8E-A-M8-4</b>	
<b>Position sensor</b>					
	Analogue sensor for VTEM input module	Sensing range 0 ... 50 mm	<b>8050120</b>	<b>SDAP-MHS-M50-1L-A-E-0.3-M8</b>	
		Sensing range 0 ... 100 mm	<b>8050121</b>	<b>SDAP-MHS-M100-1L-A-E-0.3-M8</b>	
		Sensing range 0 ... 160 mm	<b>8050122</b>	<b>SDAP-MHS-M160-1L-A-E-0.3-M8</b>	
<b>Connecting cable</b>					
	Modular system for a choice of connecting cables	Cable length 0.1 ... 30 m	<b>539052</b>	Datasheets → Internet: nebu <b>NEBU-...</b>	
		<ul style="list-style-type: none"> <li>• Straight plug, 4-pin</li> <li>• Straight socket, M8x1, 4-pin</li> </ul>	Cable length 2.5 m	<b>554035</b>	<b>NEBU-M8G4-K-2.5-M8G4</b>
<b>Cover cap</b>					
	Cover cap for sealing unused connections	For M8 connections	Pack size 10	<b>177672</b>	<b>ISK-M8</b>

## Datasheet – Motion App "Directional control valve functions"

- 2x 2/2-way valve
- 2x 3/2-way valve
- 4/2-way valve
- 4/3-way valve
- Part of the basic package

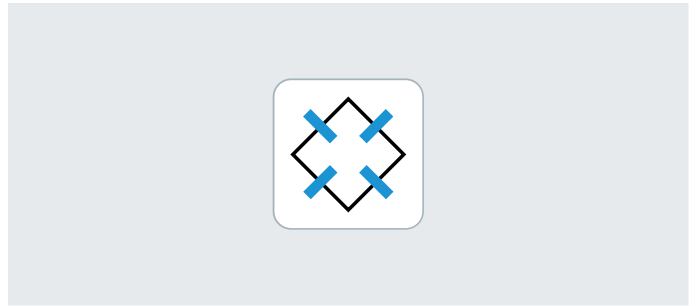

### Description

#### Mode of operation

The directional control valve function allows the characteristics of a conventional pneumatic valve to be assigned to a valve position.

The integrated sensors enable the switching position to be monitored. All ports are blocked if the pilot pressure or power supply is interrupted.

#### Panel

The ability to assign the directional control valve function significantly reduces component variety. This in turn reduces the initial design costs. If a replacement is required, it is no longer necessary to identify the specific valve; the controller assigns the function to the new valve. As valve functions are assigned cyclically, a series of valve functions can be realised on one valve position at staggered intervals.

When maintenance and commissioning need to be carried out, the valves can be stopped as required via the controller and can exhaust the system.

- One valve position with 9 valve functions
- No need to change the valve for a different valve function
- Virtual manual override via software, access via Ethernet interface

#### Scope

- For the entire Motion Terminal
- For each individual valve position in a Motion Terminal, depending on the assignment
- Cyclical assignment

#### Data

Controller to the valve

- Directional control valve function
- Switching position to be assumed

Valve to the controller

- Switching position
- Pressure at port 2
- Pressure at port 4

Valve functions		Valve functions	
Circuit symbol	Description	Circuit symbol	Description
<b>2x 3/2-way valve</b>		<b>4/3-way valve</b>	
	<ul style="list-style-type: none"> <li>• Bistable</li> <li>• Normally open</li> <li>• Not reversible</li> </ul>		<ul style="list-style-type: none"> <li>• Mid-position pressurised</li> <li>• Not reversible</li> </ul>
	<ul style="list-style-type: none"> <li>• Bistable</li> <li>• Normally closed</li> <li>• Not reversible</li> </ul>		<ul style="list-style-type: none"> <li>• Mid-position closed</li> <li>• Not reversible</li> </ul>
	<ul style="list-style-type: none"> <li>• Bistable</li> <li>• Normal position                             <ul style="list-style-type: none"> <li>– 1x closed</li> <li>– 1x normally open</li> </ul> </li> <li>• Not reversible</li> </ul>		<ul style="list-style-type: none"> <li>• Mid-position exhausted</li> <li>• Not reversible</li> </ul>
<b>4/2-way valve</b>		<b>2x 2/2-way valve</b>	
	<ul style="list-style-type: none"> <li>• Monostable</li> <li>• Pneumatic reset</li> <li>• Not reversible</li> </ul>		<ul style="list-style-type: none"> <li>• Bistable</li> <li>• Normally closed</li> <li>• Not reversible</li> </ul>
	<ul style="list-style-type: none"> <li>• Bistable</li> <li>• Not reversible</li> </ul>		



## Datasheet – Motion App "Directional control valve functions"

Technical data			
Response time	On	[ms]	8.5
	off	[ms]	8.5
Standard nominal flow rate for pressurisation		[l/min]	450
Standard nominal flow rate for exhausting		[l/min]	480

## Datasheet – Motion App "Proportional directional control valve"

- 4/3-way proportional valve
- 2x 3/3-way proportional valve
- Part of the basic package

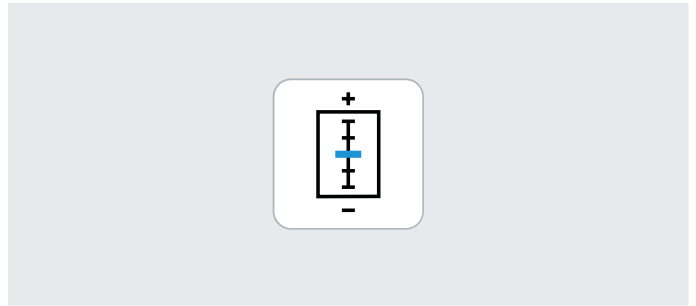

### Description

#### Mode of operation

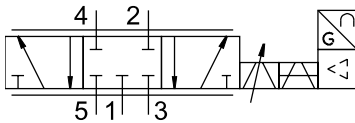

The proportional directional control valve function is assigned to a valve position in the same way as the directional control valve function.

The switching position and degree of opening of the valves can be monitored via the integrated sensors.

#### Panel

- Minimal leakage (poppet valves)
- Low current consumption
- Two independently controlled connections at one valve position
- Different control characteristics can be set

#### Scope

- For the entire Motion Terminal
- For each individual valve position in a Motion Terminal, depending on the assignment
- Cyclical assignment

#### Data

##### Controller to the valve

- Directional control valve function
- Switching position to be assumed
- Control characteristics
- Valve position (-100 ... +100%)
- Port blocking

##### Valve to the controller

- Measured valve position (-100 ... +100%)

#### Valve functions

Circuit symbol	Description	Circuit symbol	Description
<b>2x 3/3-way proportional valve</b> 	<ul style="list-style-type: none"> <li>• Mid-position closed</li> <li>• Not reversible</li> </ul>	<b>4/3-way proportional valve</b> 	<ul style="list-style-type: none"> <li>• Mid-position closed</li> <li>• Not reversible</li> </ul>

#### Technical data

Linearity error	[%]	±2 FS, 5 ... 70% setpoint value
	[%]	Typically ±3 FS, 70 ... 95% setpoint value relative to the ideal characteristic curve
Repetition accuracy in ± % FS	[%]	±1.5 FS
Hysteresis	[%]	1.5 FS, 5 ... 70% setpoint value
	[%]	Typically 3 FS, 70 ... 95% setpoint value
Overall accuracy	[%]	Typically 3 FS
Response sensitivity	[%]	1.5 FS

# Datasheet – Motion App "Proportional pressure regulation"

 Pressure -0.9 ... +7 bar

- Pressure regulation in port 2
- Pressure regulation in port 4
- Licences required for the number of simultaneous usages

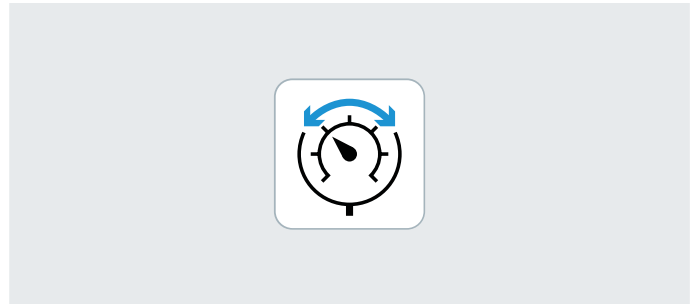

## Description

### Mode of operation

With the proportional pressure regulation function the pressure can be regulated at ports 2 and 4 independently

The integrated sensors enable the pressure to be precisely monitored.

The following control characteristics are available:

- Small volume
- Medium volume
- Large volume
- Self-configured setting

For vacuum applications, a vacuum is connected to port 3. Pressure, for an ejector pulse for example, can be connected at port 1 at the same time.

### Panel

- Two pressure regulators per valve position
- Easy parameterisation
- Vacuum regulation

### Scope

- For the entire Motion Terminal
- For each individual valve position in a Motion Terminal, depending on the assignment
- Cyclical assignment

### Data

Controller to the valve

- Pressure at port 2 (setpoint value)
- Pressure at port 4 (setpoint value)

Valve to the controller

- Pressure at port 2 (actual value)
- Pressure at port 4 (actual value)

### Range of applications

- Regulating the force with known effective area
- Regulating contact pressure
- Actuating process valves
- Vacuum control with ejector pulse

## Technical data

Linearity error	[mbar]	<80, within a range of -0.9 ... 7 bar, relative to the ideal characteristic curve	Conditions: • Valid within a range of 5 ... 95% of the setpoint value • Supply pressure 8 bar • Volume 0.1 l • Control characteristic C1 • Only one pressure regulator active within the valve terminal
Repetition accuracy	[mbar]	<40, within a range of -0.9 ... 7 bar	
Hysteresis	[mbar]	<40, within a range of -0.9 ... 7 bar	
Overall accuracy	[mbar]	<90, within a range of -0.9 ... 7 bar	

## Pressure as a function of the flow rate

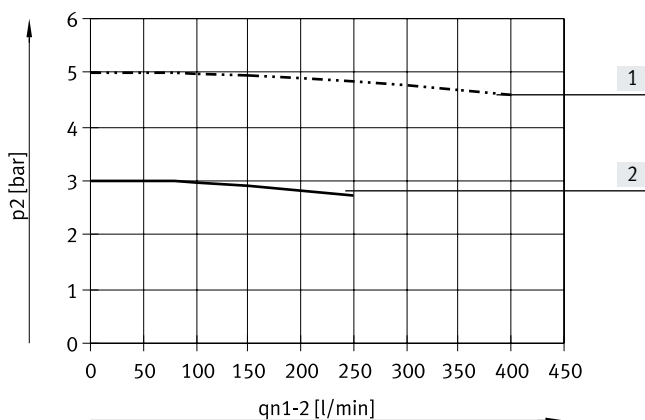

- [1] Characteristic pressure curve with a specified setpoint value of 5 bar
- [2] Characteristic pressure curve with a specified setpoint value of 3 bar

## Datasheet – Motion App "Supply and exhaust air flow control"

- Supply air flow control
- Exhaust air flow control
- Part of the basic package

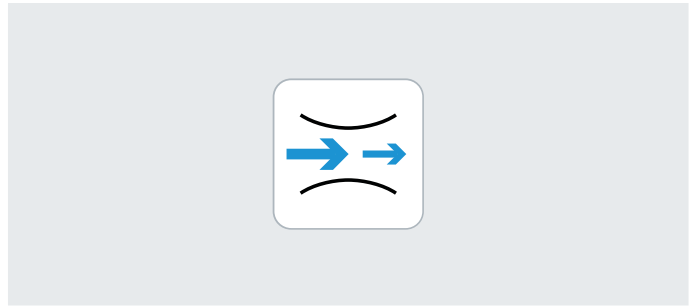

### Description

#### Mode of operation

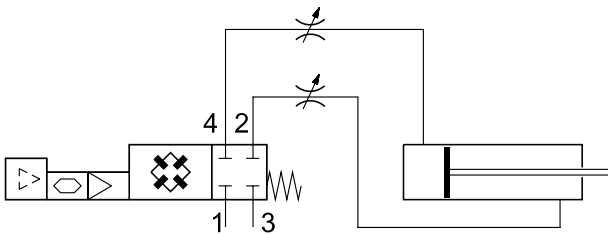

The flow rate can be individually adjusted for each duct; the supply air and exhaust air flow control are adjusted independently of one another.

It is no longer necessary to have a technician on site to change the flow control.

#### Panel

- Flow control remotely adjustable during operation (adjustment via controller)
- Reproducible flow control cross sections adjustable via controller
- Reduced component variety since there is no mechanical flow control valve
- Flow control setting can be called up during operation
- Tamper-proof

#### Scope

- For the entire Motion Terminal
- For each individual valve position in a Motion Terminal, depending on the assignment
- Cyclical assignment
- Control precision  $\pm 3\%$

#### Data

##### Controller to the valve

- Supply air flow control setting  
0 ... 100%  
(recommended values: 5 ... 100%)
- Exhaust air flow control setting  
0 ... 100%  
(recommended values: 5 ... 100%)
- Increments 0.01%

##### Valve to the controller

- Supply air flow control setting
- Exhaust air flow control setting

#### Soft-start function

If, on starting the Motion App, the pressure at ports 2 and 4 is more than 50% below the current pressure in port 1, it is steadily increased until the specified value has been reached. The actual motion task then starts.

This function prevents advancing to the end position in an uncontrolled manner.

#### Technical data

Overall accuracy	[%]	Typically $\pm 3$
------------------	-----	-------------------

## Datasheet – Motion App "ECO drive"

- Supply air flow control with end-position switch-off
- Can be used to save energy when advancing and retracting the cylinder
- Part of the basic package

Also required:

- A digital input module CTMM
- Two digital sensors (PNP, N/O contact) for determining the end position of the drive



### Description

#### Mode of operation

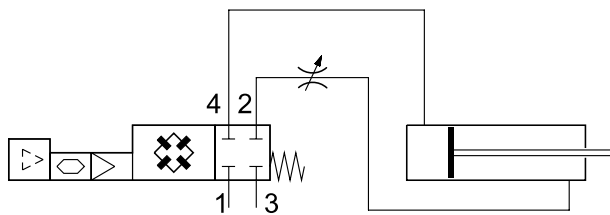

To save energy during cylinder movement, the supply air flow is controlled when advancing the cylinder while the exhaust air flow is not controlled. The supply air side is blocked when the end position is reached so the pressure level and cylinder position can be maintained.

For this function, the cylinder position is sensed via two end-position switches.

For safe operation, a horizontal travel movement/mounting position is recommended. The acceleration and speed of the movement are significantly increased by a force acting in the same direction.

#### Characteristic pressure curve without ECO drive

Pressure at port 2

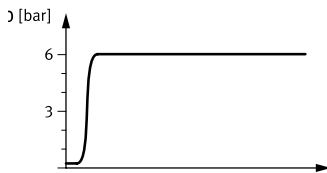

Pressure at port 4

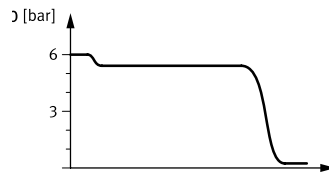

- High pressure at port 2
- High pressure at port 4
- Supply air unthrottled
- Exhaust air flow control

- Differential pressure in line with the required amount of force for the motion
- High force in the end position
- High energy consumption

#### Pressure curve with ECO drive

Pressure at port 2

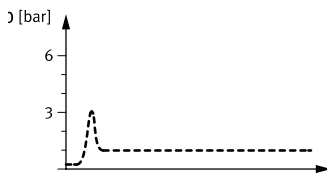

Pressure at port 4

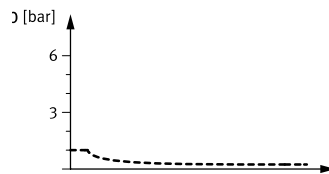

- Low pressure at port 2
- Low pressure at port 4
- Supply air flow control
- Exhaust air flow unthrottled

- Differential pressure in line with the required amount of force for the motion
- Low force in the end position
- Low energy consumption

### Panel

- Supply air flow control and pressure switch-off in the end position considerably increase energy efficiency
- Energy/pressure consumption is automatically adapted to the load
- Readjustment in case of deviation from the end position
- Suitable for moving low loads at low speed

### Scope

- For the entire Motion Terminal
- For each individual valve position in a Motion Terminal, depending on the assignment
- Cyclical assignment

### Data

#### Controller to the valve

- Supply air flow control setting  
5 ... 100%

#### Valve to the controller

- Pressure at port 2
- Pressure at port 4
- End position reached

### Technical data

Overall accuracy	[%]	Typically ±3
------------------	-----	--------------

## Datasheet – Motion App "Presetting of travel time"

- Self-learning exhaust air flow control for regulating the travel time
  - Part of the basic package
- Also required:
- A digital input module CTMM
  - Two digital sensors (PNP, N/O contact) for determining the end position of the drive



### Description

#### Mode of operation

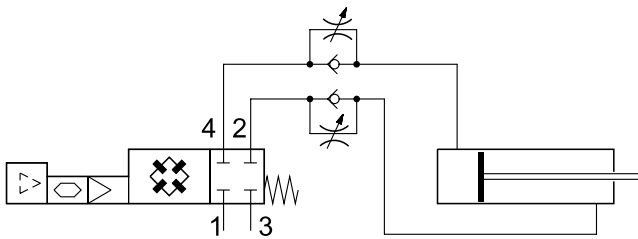

The travel time for retracting and advancing is preset in the Motion Terminal VTEM. The real travel time is autonomously determined using the sensor data from the end-position switches and the exhaust air flow control is adjusted until the specified travel time is achieved. Continuous monitoring and adjustment compensate for changes to the system.

Significant deviations in the parameters (deviating idle times, rapid change in external forces/friction forces) can cause deviations in travel time. End-position cushioning must be implemented separately.

#### Panel

- Adaptive and self-adjusting
- Constant cycle times
- Travel time can be changed via the controller
- Variations in the supply or exhaust air pressure are automatically sensed and taken into consideration
- Password-protected access
- Simple proximity switches are used

#### Scope

- For the entire Motion Terminal
- For each individual valve position in a Motion Terminal, depending on the assignment
- Cyclical assignment
- In combination with limit switch

#### Data

##### Controller to the valve

- Advancing
- Retracting
- Exhausting both chambers
- Blocking both chambers

##### Valve to the controller

- Measured travel time
- End position reached

#### Soft-start function

If, on starting the Motion App, the pressure at ports 2 and 4 is more than 20% below the current pressure in port 1, it is steadily increased until the specified value has been reached. The actual motion task then starts.

This function prevents advancing to the end position in an uncontrolled manner.

#### Technical data

Repetition accuracy	Standard deviation $\pm 3\%$ , but in any case not more accurate than $\pm 20$ ms	Conditions: <ul style="list-style-type: none"> <li>• Cylinder diameter 25 ... 63</li> <li>• Cylinder stroke 50 ... 500 mm</li> <li>• Tube length <math>\leq 5 \times</math> cylinder stroke</li> <li>• Speed <math>\geq 0.2</math> m/s</li> <li>• Mass [kg] <math>\leq 0.004 \times</math> supply pressure [bar] <math>\times</math> cylinder diameter [mm] <math>\times</math> cylinder diameter [mm]</li> </ul>
---------------------	---	---

## Datasheet – Motion App "Selectable pressure level"

- Pressure regulation at port 2 and flow rate at port 4
- Pressure regulation at port 4 and flow rate at port 2
- Licences required for the number of simultaneous usages

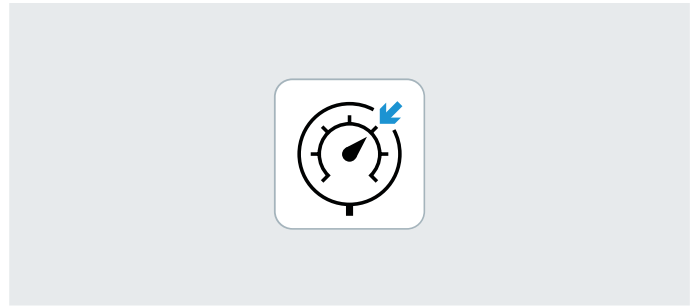

### Description

#### Mode of operation

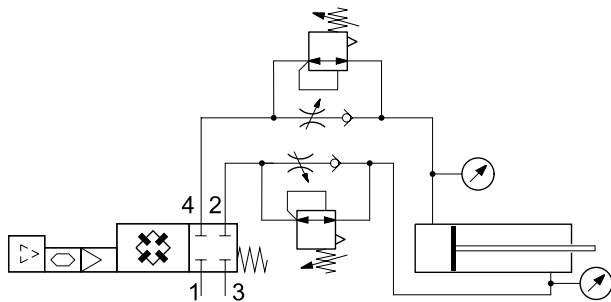

The required setpoint value can be independently preset for ducts 2 and 4. The Motion Terminal VTEM autonomously regulates the pressure and signals the actual pressure in ports 2 and 4 and to the higher-order controller.

Pressure regulation takes place in the supply port, while the preset exhaust air flow control is active in the other port. Variably adjustable pressures in the end position enable a defined force (e.g. press-fitting) to be reproduced in the application.

#### Panel

- Energy-saving movement with reduced pressure
- Pressure regulation in the end position
- Pressure can be changed remotely and individually preset for each drive and direction of movement

#### Scope

- For the entire Motion Terminal
- For each individual valve position in a Motion Terminal, depending on the assignment
- Cyclical assignment
- For cylinders with pneumatic cushioning

#### Data

##### Controller to the valve

- Pressure at port 2 and flow control opening at port 4
- Pressure at port 4 and flow control opening at port 2
- Stopping
- Advancing
- Retracting
- Exhausting both chambers

##### Valve to the controller

- Pressure at port 2 and port 4

#### Soft-start function

If, on starting the Motion App, the pressure at ports 2 and 4 is below 2 bar, it is increased steadily until the specified value has been reached. The actual motion task then starts.

This function prevents advancing to the end position in an uncontrolled manner.

#### Technical data

Repetition accuracy	[mbar]	Typically 8 (pressure regulation)
Overall accuracy	[mbar]	Typically ±250 (pressure regulation)
	[%]	Typically ±3 (opening cross section)

## Datasheet – Motion App "Flow control"

- Specification of mutually independent flow rates for ports 2 and 4
  - Open-loop operation without additional sensors
  - Closed-loop operation with external flow sensors for increased accuracy
  - Licences required for the number of simultaneous usages
- Also required for closed-loop operation:
- An analogue input module CTMM
  - A flow sensor (e.g. SFAB or SFAH) for each port

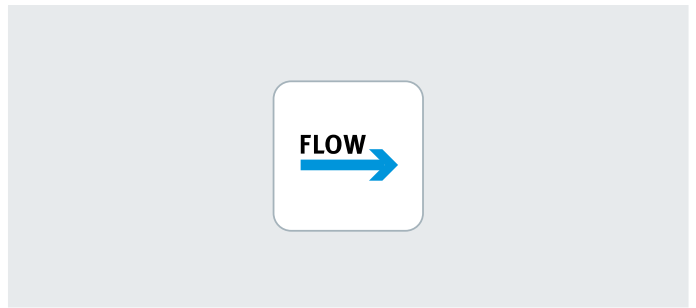

### Description

#### Mode of operation

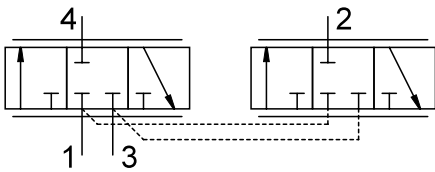

The required flow rate can be independently preset for ducts 2 and 4. The Motion Terminal VTEM autonomously regulates the flow rate and signals the actual pressure in ports 2 and 4 and to the higher-order controller.

The following control characteristics are available:

- Fast
- Medium
- Universal
- Self-configured setting

#### Panel

- Two flow controllers per valve position
- Different media can be selected
- Increased accuracy through closed-loop operation when using external flow sensors
- Different control characteristics can be set

#### Scope

- For each individual valve position in a Motion Terminal, depending on the assignment
- Cyclical assignment

#### Data

- |  |   |
|--|---|
| <b>Controller to the valve</b> <ul style="list-style-type: none"> <li>• Setpoint flow rate at port 2</li> <li>• Setpoint flow rate at port 4</li> <li>• Ports can be activated individually and independently</li> </ul> | <b>Valve to the controller</b> <ul style="list-style-type: none"> <li>• Flow rate at port 2</li> <li>• Flow rate at port 4</li> <li>• Status information</li> </ul> |
|--|---|

#### Media

- CDA (dried air)
- Ar (argon)
- N2 (nitrogen)
- CO2 (carbon dioxide)
- O2 (oxygen), on request

### Technical data

Accuracy of flow rate (max. stationary control precision)	Closed-loop: $\pm 4$ l/min <sup>1)</sup> Open-loop: not specified
--	--

1) Filtered sensor value for setpoint value and corresponding control characteristics



## Datasheet – Motion App "Soft Stop"

- The algorithm moves the piston from one cylinder end position to the other in an optimum amount of time
- Licences required for the number of simultaneous usages

Also required:

- An analogue input module CTMM
- Two sensors SDAP for determining the position of the drive

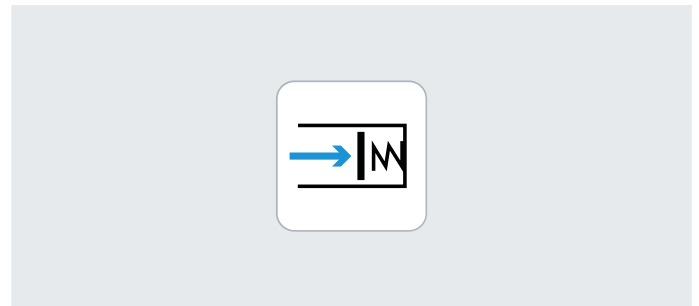

### Description

#### Mode of operation

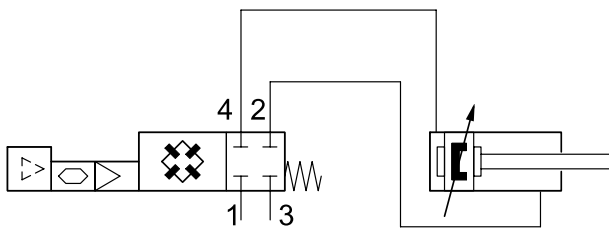

During a teach-in process, the Motion Terminal VTEM automatically determines the necessary parameters for accelerating the connected drive in a controlled manner and decelerating it gently.

Gradual changes over the course of continuous operation are automatically compensated for.

#### Panel

- Optimised cycle times (typical travel time 0.5 s for a piston rod cylinder with a 32 mm piston rod diameter, 500 mm stroke and 11 kg moving mass)
- Automatic cushioning resulting in considerably less wear, vibrations or impacts
- Optimal for heavy moving masses and long travel paths
- Selectable contact pressure in end position

#### Scope

- For each individual valve position in a Motion Terminal, depending on the assignment
- Cyclical assignment
- In combination with partial stroke sensor
- For drives with self-adjusting pneumatic cushioning (PPS) on both sides

#### Data

##### Controller to the valve

- Advancing
- Retracting
- Exhausting
- Blocking

##### Valve to the controller

- End position reached
- Contact pressure reached

#### Soft-start function

When the Motion App is started, the piston position and pressure conditions are checked.

If the piston is in the end position:

- The pressure of the port to be exhausted will be adjusted to the pre-set contact pressure
- The port to be pressurised will be completely exhausted

If the piston is not in the end position, the cylinder will be moved gently into the end position of the specified direction.

The actual motion task then starts. This function prevents advancing to the end position in an uncontrolled manner.

### Technical data

Repetition accuracy

Expanded measurement uncertainty (95%) <70 ms with periodic advancing and retracting

## Datasheet – Motion App "Leakage diagnostics"

-  - Flow rate  
Measuring range: 2 ... 50 l/h

• Part of the basic package



### Description

#### Mode of operation

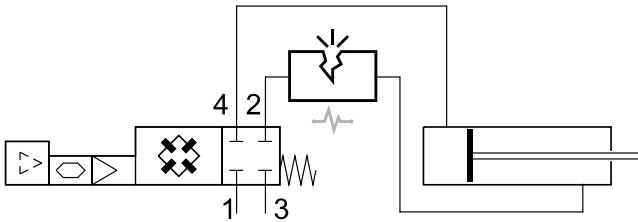

To calculate the leakage, the pressure drop at a valve (drive in end position) is determined.

To be able to evaluate this value, a reference value is determined using a measurement taken at the start of the observation period.

The Motion Terminal VTEM compares the value of further measurements against this reference value.

This comparison provides the basis for an evaluation using adjustable limits. The evaluation and the difference between the measured value and the reference value are fed back.

During the diagnostics, the motion task independently advances and retracts the cylinder.

Leakage testing is not performed during operation; it is started separately as a test cycle.

#### Panel

Increased leakage can be caused by a critical fault (damaged tubing) or by wear and ageing of the connected components.

Regular leakage testing can therefore:

- Determine a sudden leak
- Detect wear on cylinders and valves in good time

#### Scope

- For all valve positions of a Motion Terminal
- Requires a test run

- Not for vacuum applications
- For all types of pneumatic consumers

#### Data

##### Controller to the valve

- Start diagnostics
- Terminate diagnostics
- Start reference measurement
- Terminate reference measurement
- Exhausting

##### Valve to the controller

- Status of the detection
- Change in leakage for port 2
- Change in leakage for port 4
- Evaluation of leakage at port 2
- Evaluation of leakage at port 4

#### Technical data

Repetition accuracy	[l/h]	$\pm(2+0.15 \times \text{actual leakage})$	Conditions: <ul style="list-style-type: none"> <li>• Total volume of the connected pneumatic system including tubing 0.08 ... 5 l</li> <li>• Supply pressure 0.5 ... 8 bar</li> <li>• Leakage range 0 ... 50 l/h</li> <li>• A force acting on the connected drive can amount to max. 75% of the effective pneumatic force.</li> </ul>
---------------------	-------	--	---

## Datasheet – Motion App "Positioning"

- The control algorithm moves the piston to the desired setpoint position using the parameterised dynamics
- Licences required for the number of simultaneous usages (max. 2 licences per valve terminal)
- Can be used on Motion Terminals with up to 4 valve slices

Also required:

- An analogue input module CTMM
- Depending on the stroke, up to two displacement encoders for determining the position of the drive (the encoder(s) must be able to detect the entire range of motion of the drive)

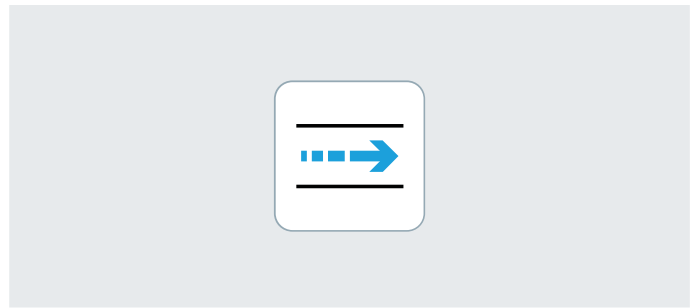

### Description

Mode of operation

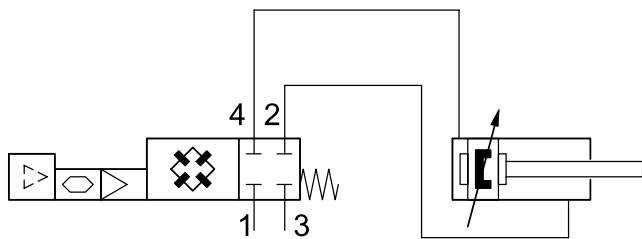

With the Motion App "Positioning" pneumatic drives can be freely positioned along the entire stroke. Using analogue sensors to measure the piston position means that the algorithm always knows the precise position of the drive.

Dynamic setpoints for position and maximum speed enable pneumatic positioning tasks to be highly customised. The initial teach-in run helps to ensure fast commissioning.

### Panel

- High-speed pre-positioning
- Controlled movement profile can be configured using parameters (e.g. high dynamic response or fast motion with gentle end stop)
- Energy-saving cylinder movement possible by lowering the pressure level via parameterisation
- Stable in response to changes caused by wear
- Option of presetting a final speed for tasks involving contact

### Scope

- For each individual valve position in a Motion Terminal, depending on the assignment
- Cyclical assignment
- In combination with position measurement of the entire range of motion
- Tubing lengths up to 3 m possible
- Suitable for applications with both high and low loads

### Data

Controller to the valve

- Target position
- Max. speed
- Move to target position
- Stop in a controlled manner
- Blocking
- Exhausting

Valve to the controller

- Actual position
- Drive force
- End position reached
- Target position reached
- Overshooting of target position in planned path
- Controlled stopping due to non-observance of the end-position

### Soft-start function





On starting the Motion App, the pressure level at the working ports is checked. If the measured pressure level is outside the specified midpressure tolerance level of  $\pm 1$  bar, the pressure level is first of all built up and the positioning movement is started once the tolerance level is reached.

If the measured pressure level is within the specified tolerance, the movement is started immediately.

### Technical data

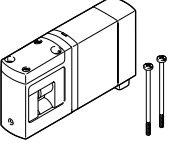
Parameter	Unit	Value	Conditions:									
Positioning accuracy	[mm]	Typically $\pm 1.5$	<ul style="list-style-type: none"> <li>• Precision specifications are based on the measurement system (for displacement encoder requirements, see for Motion App user documentation)</li> <li>• Mounting position: horizontal or vertical</li> <li>• Drives supported: DSBC...</li> <li>• Cylinder lengths: 30 ... 500 mm</li> <li>• Cylinder diameter: 32, 40 and 50 mm</li> <li>• Tubing lengths: 1 ... 3 m</li> <li>• Tubing types: PUN-8... / PAN-8...</li> <li>• Supply pressure: 6 ... 8 bar (rel)</li> <li>• Mid-pressure                             <ul style="list-style-type: none"> <li>– Max. mid-pressure &lt; supply pressure (rel) – 2 bar</li> <li>– Min. mid-pressure &gt; exhaust pressure (rel) + 2.5 bar</li> </ul> </li> <li>• Cylinder diameter [mm] - Minimum mass [kg]</li> </ul>									
Overshoot relative to setpoint position	[mm]	< $\pm 2.5$										
Response sensitivity (smallest setpoint value change, the latest time at which the closed-loop controller responds)	[ms]	10										
			<table border="1"> <tr> <td>32</td> <td>-</td> <td>1</td> </tr> <tr> <td>40</td> <td>-</td> <td>2</td> </tr> <tr> <td>50</td> <td>-</td> <td>3</td> </tr> </table>	32	-	1	40	-	2	50	-	3
32	-	1										
40	-	2										
50	-	3										

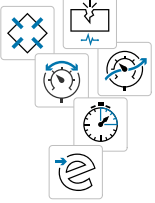
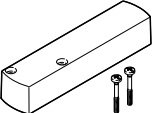
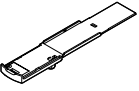

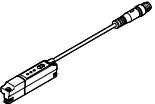

Accessories

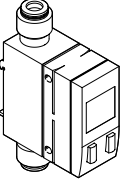
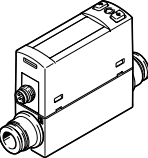
Ordering data			Part no.	Type
<b>Valve</b>				
	Valve for one valve position		8047503	VEVM-S1-27-B-C-F-1T1L
<b>Input module</b>				
	Module with 8 inputs	Digital inputs	8047505	CTMM-S1-D-8E-M8-3
		Analogue inputs	8047506	CTMM-S1-A-8E-A-M8-4
	Cover cap for sealing unused connections	For M8 connections	Pack size 10	177672 ISK-M8
<b>Motion App</b>				
	Basic package (basic Motion Apps)	<ul style="list-style-type: none"> <li>• Directional control valve functions</li> <li>• Proportional directional control valve</li> <li>• Supply and exhaust air flow control</li> <li>• ECO drive</li> <li>• Leakage diagnostics</li> </ul>		-
	Directional control valve functions		8070377	GAMM-A1
	Proportional directional control valve		8070378	GAMM-A2
	Proportional pressure regulation		8072609	GAMM-A3
	Supply and exhaust air flow control		8072611	GAMM-A5
	ECO drive		8072612	GAMM-A6
	Presetting of travel time		8072613	GAMM-A7
	Selectable pressure level		8072614	GAMM-A8
	Flow control		8143568	GAMM-A10
	Soft Stop		8072615	GAMM-A11
Leakage diagnostics		8072616	GAMM-A12	
Positioning		8116173	GAMM-A33	
<b>Accessories</b>				
	Cover plate for a valve position or input module position		8047504	VABB-P11-27-T
	Inscription label holder for a valve	Pack size 4	8047501	ASCF-H-P11
	H-rail mounting		8047542	VAME-P11-MK
<b>Position sensor</b>				
	Analogue sensor for VTEM input module	Sensing range 0 ... 50 mm	8050120	SDAP-MHS-M50-1L-A-E-0.3-M8
		Sensing range 0 ... 100 mm	8050121	SDAP-MHS-M100-1L-A-E-0.3-M8
		Sensing range 0 ... 160 mm	8050122	SDAP-MHS-M160-1L-A-E-0.3-M8

## Accessories

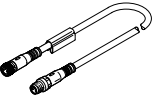
Ordering data – Flow sensor						
	Flow measuring range final value	Electrical connection 1, connection technology	Type of mounting	Pneumatic connection	Part no.	Type
<b>Measurement method: heat loss</b>						Datasheets → Internet: sfab
	50 l/min	M12x1, A-coded to EN 61076-2-101	<ul style="list-style-type: none"> <li>• With through-hole</li> <li>• With H-rail</li> </ul>	For tubing O.D. 6 mm	<b>565389</b>	<b>SFAB-50U-HQ6-2SA-M12</b>
			<ul style="list-style-type: none"> <li>• With through-hole</li> <li>• With H-rail</li> <li>• Via wall/surface bracket</li> </ul>	For tubing O.D. 6 mm	<b>565391</b>	<b>SFAB-50U-WQ6-2SA-M12</b>
	200 l/min	M12x1, A-coded to EN 61076-2-101	<ul style="list-style-type: none"> <li>• With through-hole</li> <li>• With H-rail</li> </ul>	For tubing O.D. 8 mm	<b>565393</b>	<b>SFAB-200U-HQ8-2SA-M12</b>
				For tubing O.D. 10 mm	<b>565397</b>	<b>SFAB-200U-HQ10-2SA-M12</b>
			<ul style="list-style-type: none"> <li>• With through-hole</li> <li>• With H-rail</li> <li>• Via wall/surface bracket</li> </ul>	For tubing O.D. 8 mm	<b>565395</b>	<b>SFAB-200U-WQ8-2SA-M12</b>
				For tubing O.D. 10 mm	<b>565399</b>	<b>SFAB-200U-WQ10-2SA-M12</b>
	600 l/min	M12x1, A-coded to EN 61076-2-101	<ul style="list-style-type: none"> <li>• With through-hole</li> <li>• With H-rail</li> </ul>	For tubing O.D. 10 mm	<b>565401</b>	<b>SFAB-600U-HQ10-2SA-M12</b>
				For tubing O.D. 10 mm	<b>565403</b>	<b>SFAB-600U-WQ10-2SA-M12</b>
	1000 l/min	M12x1, A-coded to EN 61076-2-101	<ul style="list-style-type: none"> <li>• With through-hole</li> <li>• With H-rail</li> </ul>	For tubing O.D. 10 mm	<b>565405</b>	<b>SFAB-1000U-HQ10-2SA-M12</b>
				<ul style="list-style-type: none"> <li>• With through-hole</li> <li>• With H-rail</li> <li>• Via wall/surface bracket</li> </ul>	For tubing O.D. 10 mm	<b>565407</b>
<b>Measurement method: heat transfer</b>						Datasheets → Internet: sfab
	50 l/min	M8x1, A-coded to EN 61076-2-104	With accessories	Female thread G1/8	<b>8058473</b>	<b>SFAH-50U-G18FS-PNLK-PNVBA-M8</b>
		Plug pattern L1J	With accessories	For tubing O.D. 8 mm	<b>8058471</b>	<b>SFAH-50U-Q8S-PNLK-PNVBA-L1</b>
	100 l/min	M8x1, A-coded to EN 61076-2-104	With accessories	Female thread G1/4	<b>8058476</b>	<b>SFAH-100U-G14FS-PNLK-PNVBA-M8</b>
				For tubing O.D. 8 mm	<b>8058475</b>	<b>SFAH-100U-Q8S-PNLK-PNVBA-M8</b>
		Plug pattern L1J	With accessories	For tubing O.D. 8 mm	<b>8058474</b>	<b>SFAH-100U-Q8S-PNLK-PNVBA-L1</b>
	200 l/min	M8x1, A-coded to EN 61076-2-104	With accessories	Female thread G1/4	<b>8058479</b>	<b>SFAH-200U-G14FS-PNLK-PNVBA-M8</b>
				For tubing O.D. 8 mm	<b>8058478</b>	<b>SFAH-200U-Q8S-PNLK-PNVBA-M8</b>
		Plug pattern L1J	With accessories	For tubing O.D. 8 mm	<b>8058477</b>	<b>SFAH-200U-Q8S-PNLK-PNVBA-L1</b>

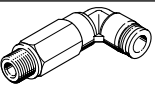
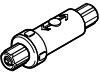
## Accessories

Ordering data			Pack size	Part no.	Type
<b>Connecting cable</b> <span style="float: right;">Datasheets → Internet: nebu</span>					
	Modular system for a choice of connecting cables	Cable length 0.1 ... 30 m	–	539052	NEBU-... → Internet: nebu
	<ul style="list-style-type: none"> <li>• Straight plug, 4-pin</li> <li>• Straight socket, M8x1, 4-pin</li> </ul>	Cable length 2.5 m	–	554035	NEBU-M8G4-K-2.5-M8G4
<b>Push-in fitting, straight</b> <span style="float: right;">Datasheets → Internet: qsm</span>					
	Connecting thread M5 for tubing O.D.	4 mm	10	★ 153315	QSM-M5-4-I
	Connecting thread M7 for tubing O.D.	6 mm	10	★ 153321	QSM-M7-6-I
	Connecting thread G1/8 for tubing O.D.	4 mm	10	★ 186095	QS-G1/8-4
			100	132036	QS-G1/8-4-100
		6 mm	10	★ 186096	QS-G1/8-6
			100	132037	QS-G1/8-6-100
		8 mm	10	★ 186098	QS-G1/8-8
		50	132038	QS-G1/8-8-50	
	Connecting thread G3/8 for tubing O.D.	8 mm	10	★ 186111	QS-G3/8-8-I
		10 mm	10	★ 186113	QS-G3/8-10-I
		12 mm	10	★ 186114	QS-G3/8-12-I
		16 mm	1	★ 186347	QS-G3/8-16
<b>Push-in fitting, angled</b> <span style="float: right;">Datasheets → Internet: qsl</span>					
	Connecting thread M5 for tubing O.D.	4 mm	10	130831	QSM-LV-M5-4-I
	Connecting thread M7 for tubing O.D.	6 mm	10	★ 186353	QSM-L-M7-6
	Connecting thread G1/8 for tubing O.D.	4 mm	10	★ 186116	QSL-G1/8-4
			100	132048	QSL-G1/8-4-100
		6 mm	10	★ 186117	QSL-G1/8-6
			100	132049	QSL-G1/8-6-100
		8 mm	10	★ 186119	QSL-G1/8-8
			50	132050	QSL-G1/8-8-50
	Connecting thread G3/8 for tubing O.D.	8 mm	10	★ 186121	QSL-G3/8-8
		10 mm	10	★ 186123	QSL-G3/8-10
12 mm		10	★ 186124	QSL-G3/8-12	
<b>Push-in fitting, angled, long</b> <span style="float: right;">Datasheets → Internet: qsl</span>					
	Connecting thread G1/8 for tubing O.D.	4 mm	10	186127	QSL-L-G1/8-4
			100	133015	QSL-L-G1/8-4-100
		6 mm	10	186128	QSL-L-G1/8-6
			100	133016	QSL-L-G1/8-6-100
		8 mm	10	186130	QSL-L-G1/8-8
			100	133017	QSL-L-G1/8-8-100
	Connecting thread G3/8 for tubing O.D.	8 mm	10	186132	QSL-L-G3/8-8
		10 mm	10	186134	QSL-L-G3/8-10
12 mm		10	186135	QSL-L-G3/8-12	
<b>Vacuum filter</b>					
	Inline filter inserted in tubing line for tubing O.D.	4 mm	–	535883	VAF-PK-3
		6 mm	–	15889	VAF-PK-4
		8 mm	–	160239	VAF-PK-6
<b>Blanking plug</b> <span style="float: right;">Datasheets → Internet: b</span>					
	For sealing ports that are not required	M5 thread	10	★ 3843	B-M5
		G1/8 thread	10	★ 3568	B-1/8
		G3/8 thread	10	★ 3570	B-3/8
<b>Silencer</b> <span style="float: right;">Datasheets → Internet: amte</span>					
	For M7 thread		1	161418	UC-M7
	For G3/8 thread		–	★ 6843	U-3/8-B