

Proportional directional control valves VPWS

FESTO



Key features

General

The solenoid valves VPWS are proportional directional control valves. This means that the flow rate of suitable media can be controlled proportionally. Approved operating media include air, oxygen and inert gases.

The solenoid valve VPWS should only be operated within the limits defined in the technical data. The specific on-site operating conditions are to be observed.

Overview of valve with manifold block

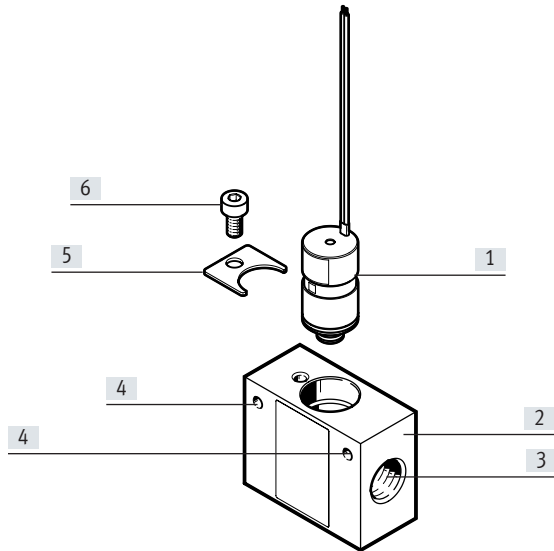

- [1] Solenoid valve VPWS
- [2] Manifold block
- [3] Pneumatic connection
- [4] Mounting hole for M3 screws
- [5] Mounting
- [6] Socket head screw M4

Note

The product has no redundancy and no error detection. When malfunctions need to be detected, this must be done by implementing the necessary measures in the customer product.

Type codes

001	Series
VPWS	Proportional directional control valve

002	Nominal width [mm]
1	1
1.5	1.5
2.2	2.2
6	6

003	Directional control valve type
B	Sub-base valve



004	Valve function
6	2/2-way valve, normally closed

005	Pneumatic connection
PC15	Cartridge 15 mm

006	Pressure range [bar]
8	0 ... 8
7	0 ... 7
3	0 ... 3

007	Sealant
V	FPM

Technical data

-  Flow rate
46 ... 220 l/min
-  Diameter of cartridge
7.5 ... 15 mm
-  Voltage
≤19 ... 19.9 V DC

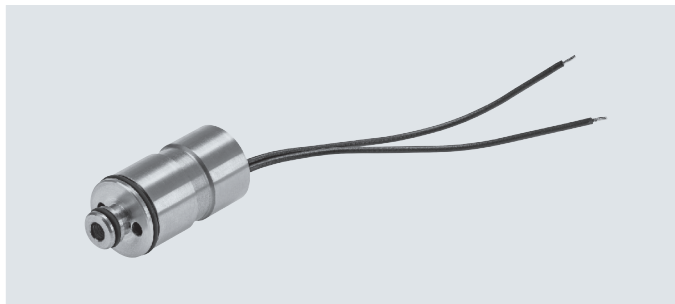
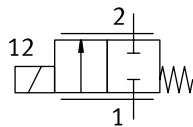

General technical data

Nominal width DN		1 mm	1.5 mm	2.2 mm	6 mm
Valve function		2/2-way proportional directional control valve, closed			
Reset method		Mechanical spring			
Design		Directly actuated poppet valve			
Sealing principle		Soft			
Actuation type		Electrical			
Type of control		Direct			
Direction of flow		Not reversible			
Mounting position		Any			
Type of mounting		On sub-base Plug-in With accessories			
Pneumatic connection 1		Cartridge 15 mm			Cartridge 7.5 mm
Pneumatic connection 2		Cartridge 7.2 mm			Cartridge 15 mm
Flow rate q	VPWS-...	[l/min]	68 ... 88	82 ... 98	46 ... 56
	VPWS-6-B-6-PC15-7-V	[l/min]	-		200 ... 220
Product weight		[g]	23		25
Degree of protection to EN 60529			IP60		
Note on degree of protection			IP65 with suitable plug In assembled state		

Operating and environmental conditions

Nominal width DN		1 mm	1.5 mm	2.2 mm	6 mm	
Medium		Inert gases Air Oxygen				
Note on the medium		Lubricated operation not possible				
Note on the medium, maximum particle size	[µm]	10				
Operating pressure	VPWS-...	[MPa]	0 ... 1	0 ... 0.8	0 ... 0.3	
		[bar]	0 ... 10	0 ... 8	0 ... 3	
	VPWS-6-B-6-PC15-7-V	[MPa]	-	-	-	0 ... 0.7
		[bar]	-	-	-	0 ... 7
Nominal operating pressure	VPWS-...	[MPa]	1	0 ... 0.8	0.3	0.2
		[bar]	10	8	3	2
		[psi]	145	116	43.5	29
	VPWS-6-B-6-PC15-7-V	[MPa]	-	-	-	0 ... 0.7
		[bar]	-	-	-	0 ... 7
		[psi]	-	-	-	101.5
Ambient temperature	[°C]	+5 ... +50				
Temperature of medium	[°C]	+5 ... +50				
Storage temperature	[°C]	-40 ... +80				
Corrosion resistance class CRC ¹⁾		1				

1) More information: www.festo.com/x/topic/kbk

Technical data

Electrical data		1 mm	1.5 mm	2.2 mm
Nominal width DN				
Continuous operating voltage at 20°C without inflow	[V DC]	≤ 16.5		
Continuous operating voltage at 50°C without inflow	[V DC]	≤ 14.5		
Typical continuous operating voltage at 50 °C with inflow	[V DC]	≤ 19.0		
Max. switching frequency	[Hz]	18		
Hysteresis	[mA]	16		
Coil resistance	[Ω]	60.5		
Max. electrical power consumption	[W]	2.5		
Current regulating range	[mA]	0 ... 200		
Duty cycle ED	[%]	100 (see assembly instructions)		

Nominal width DN		6 mm	
		Air	Oxygen
Continuous operating voltage at 20°C without inflow	[V DC]	≤ 14.5	≤ 11.4
Continuous operating voltage at 50°C without inflow	[V DC]	≤ 13.3	≤ 9.6
Typical continuous operating voltage at 50°C with inflow (≥ 30 l/min)	[V DC]	≤ 19.9	
Switching time on	[ms]	10	
Hysteresis	[mA]	22.5	
Coil resistance	[Ω]	60.5	
Max. electrical power consumption	[W]	3	
Current regulating range	[mA]	0 ... 225	
Duty cycle ED	[%]	100 (see assembly instructions)	

Electrical connection		
Electrical connection	Connection technology	Open end
	Number of pins/wires	2
	Connection type	Cable
Cable length	[mm]	70 ... 80

Materials	
Housing	High-alloy steel
Seals	FPM
Note on materials	RoHS-compliant
PWIS conformity	VDMA24364 zone III

Technical data

Flow rate/current characteristic curves

Nominal width 1 mm

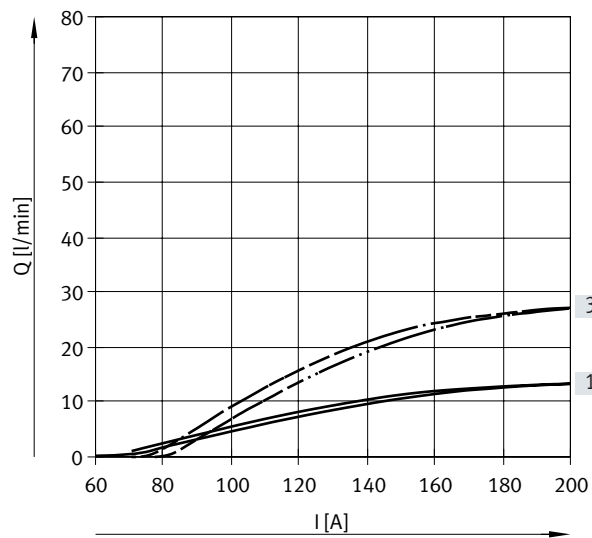

[1] Characteristic curve for 1 bar

[3] Characteristic curve for 3 bar

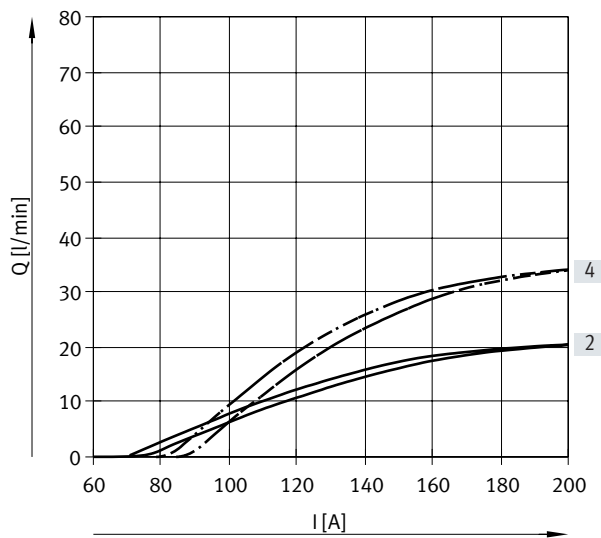

[2] Characteristic curve for 2 bar

[4] Characteristic curve for 4 bar

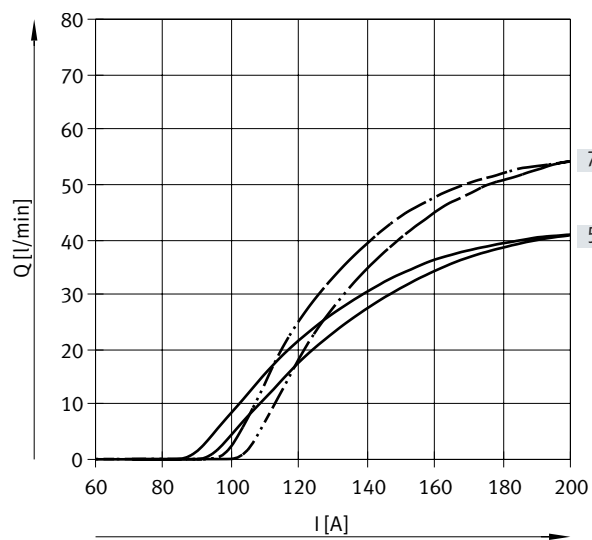

[5] Characteristic curve for 5 bar

[7] Characteristic curve for 7 bar

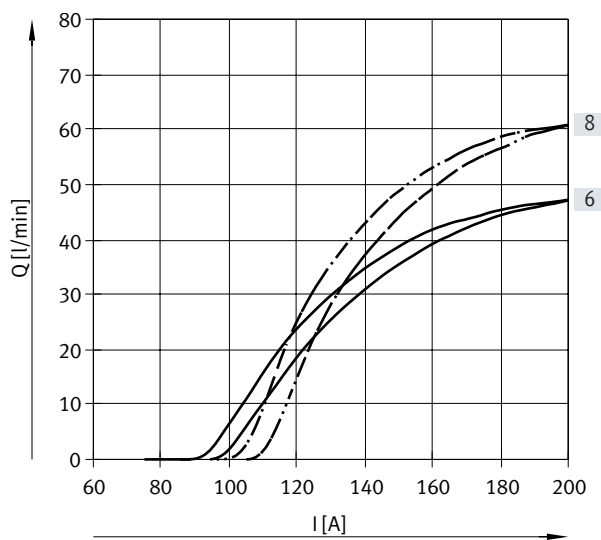

[6] Characteristic curve for 6 bar

[8] Characteristic curve for 8 bar

Technical data

Flow rate/current characteristic curves

Nominal width 1 mm

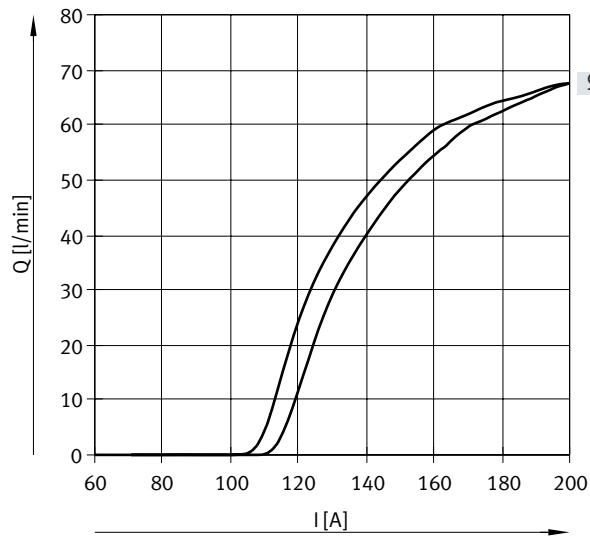

[1] Characteristic curve for 9 bar

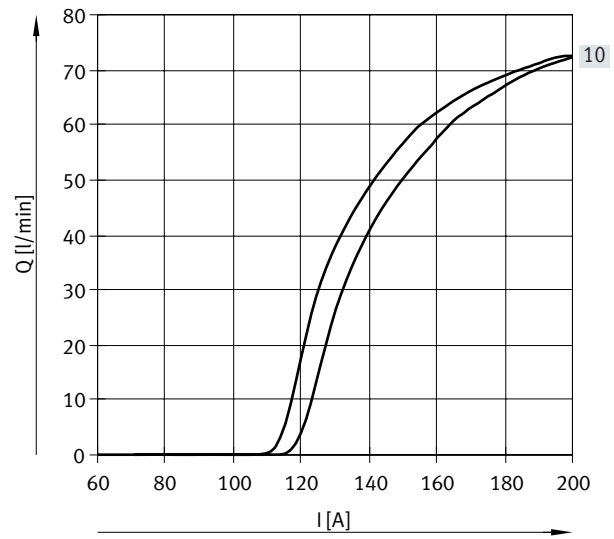

[1] Characteristic curve for 10 bar



Note

Resonance may occur during operation at a low frequency and this may affect the flow rate. Operation at very low flow rates may generate noise. No resonance occurs during operation at a frequency of 0.3 Hz or higher.

Technical data

Flow rate/current characteristic curves

Nominal width 1.5 mm

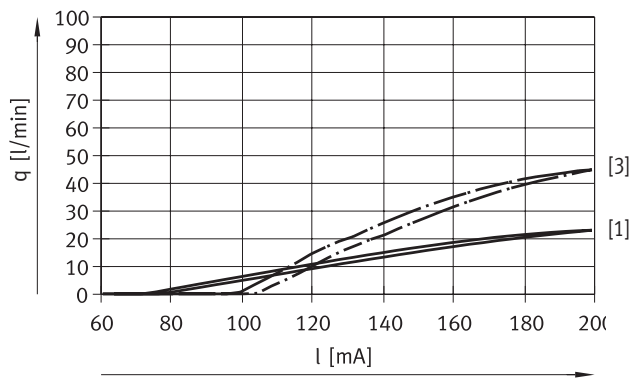

[1] Characteristic curve for 1 bar

[3] Characteristic curve for 3 bar

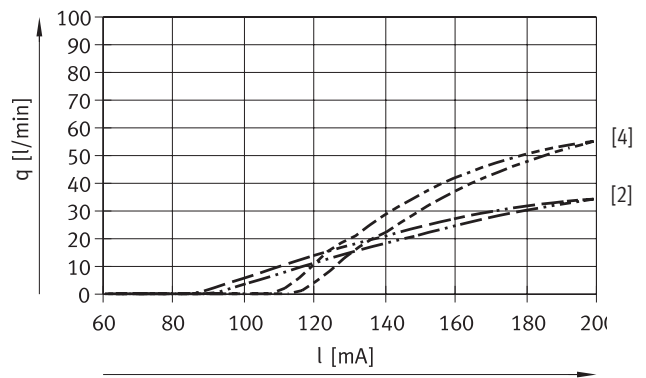

[2] Characteristic curve for 2 bar

[4] Characteristic curve for 4 bar

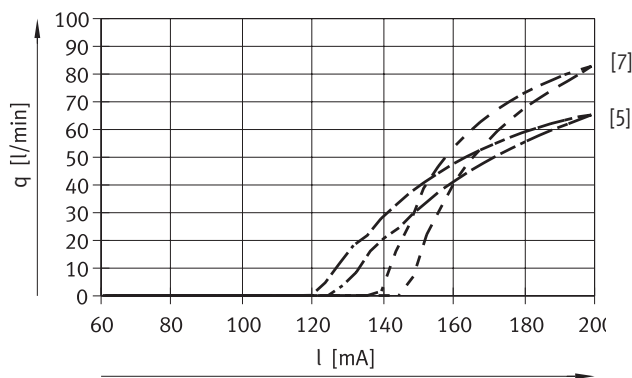

[5] Characteristic curve for 5 bar

[7] Characteristic curve for 7 bar

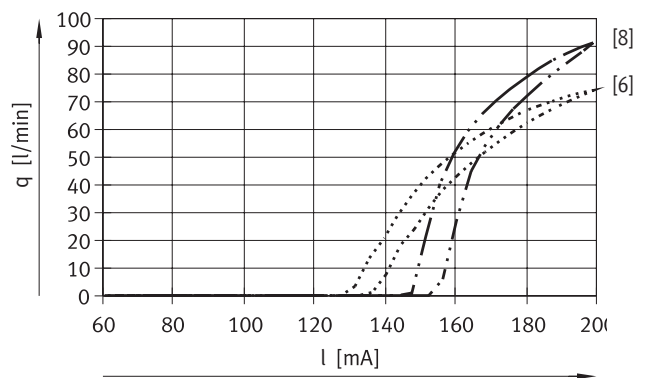

[6] Characteristic curve for 6 bar

[8] Characteristic curve for 8 bar

 **Note**

Resonance may occur during operation at a low frequency and this may affect the flow rate. Operation at very low flow rates may generate noise. No resonance occurs during operation at a frequency of 0.3 Hz or higher.

Technical data

Flow rate/current characteristic curves

Nominal width 2.2 mm

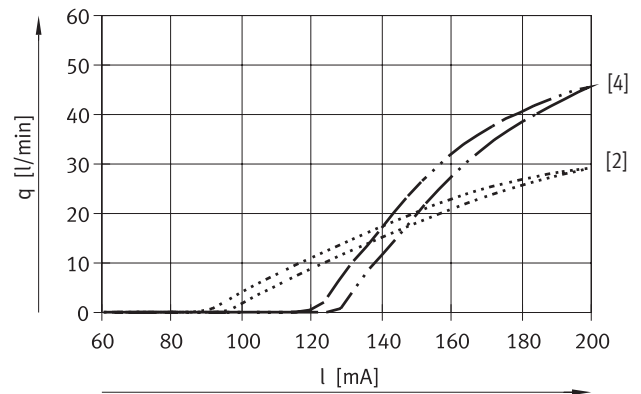
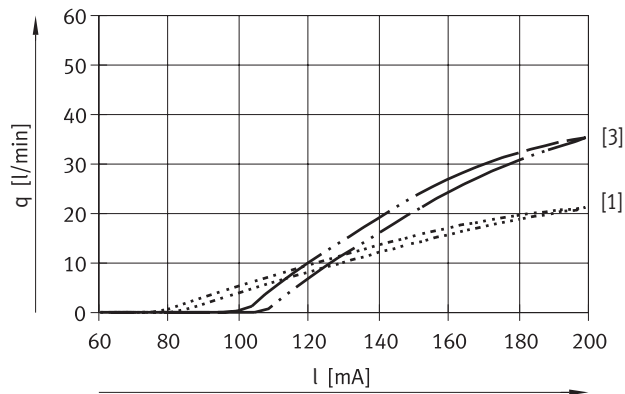

[1] Characteristic curve for 0.5 bar

[3] Characteristic curve for 1.5 bar

[2] Characteristic curve for 1.0 bar

[4] Characteristic curve for 2.5 bar

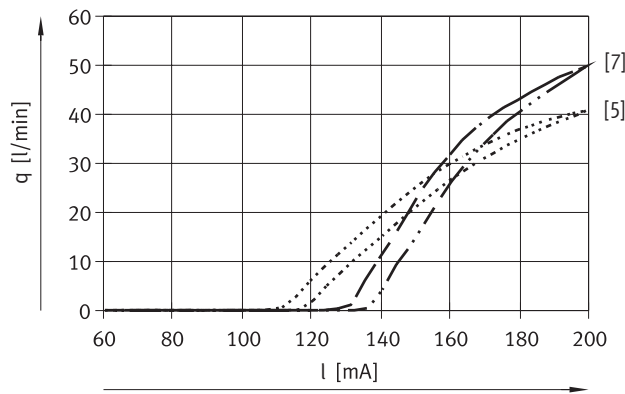

[5] Characteristic curve for 2.0 bar

[7] Characteristic curve for 3.0 bar

Flow rate/pressure characteristic curve at 200 mA

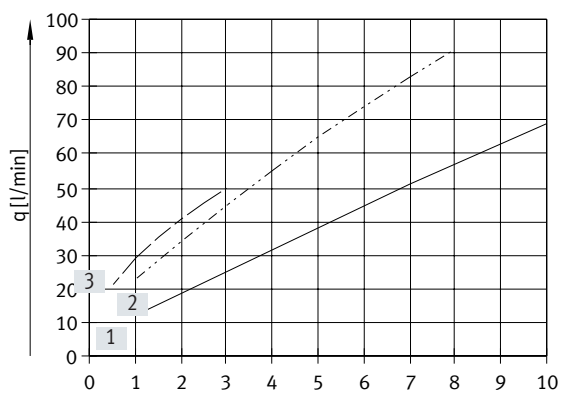

- [1] VPWS-DN 1
- [2] VPWS-DN 1.5
- [3] VPWS-DN 2.2

Technical data

Flow rate/current characteristic curves

Nominal width 6 mm, VPWS-6-B-6-PC15-3-V

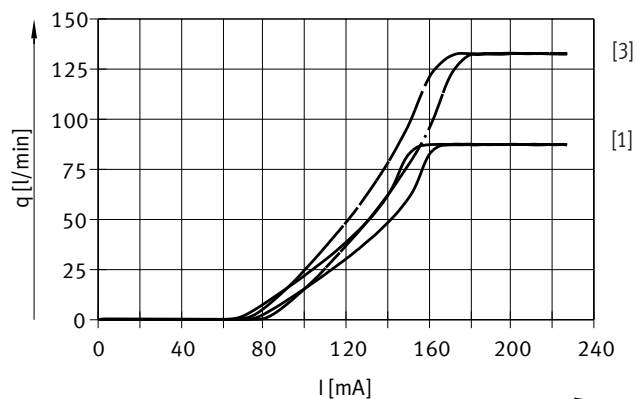

[1] Characteristic curve for 0.5 bar [3] Characteristic curve for 1 bar

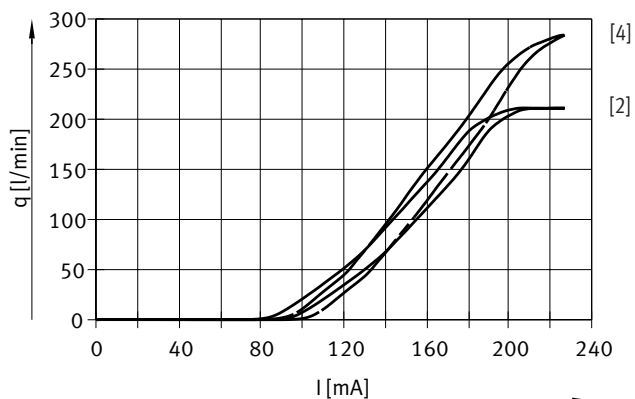

[2] Characteristic curve for 2 bar [4] Characteristic curve for 3 bar

Nominal width 6 mm, VPWS-6-B-6-PC15-7-V

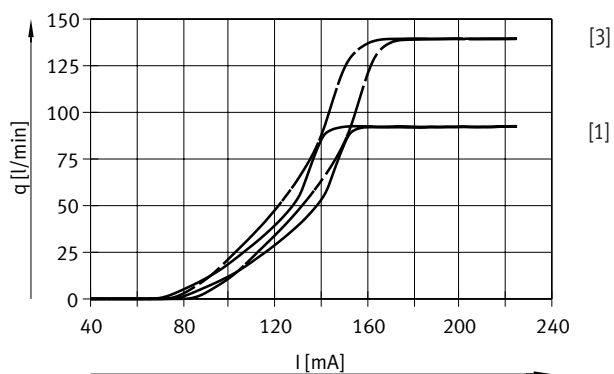

[1] Characteristic curve for 0.5 bar [3] Characteristic curve for 1 bar

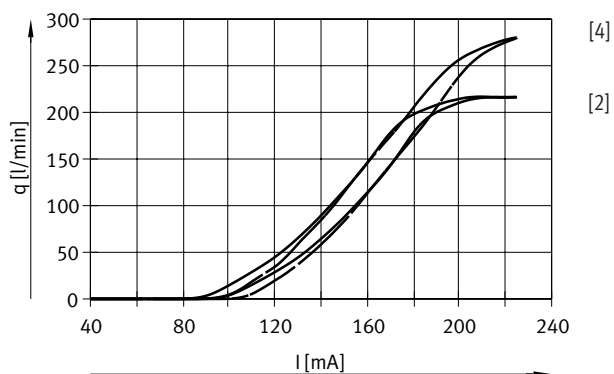

[2] Characteristic curve for 2 bar [4] Characteristic curve for 3 bar

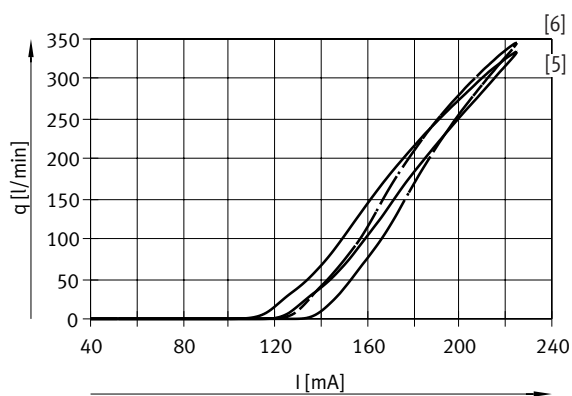

[5] Characteristic curve for 5 bar [6] Characteristic curve for 7 bar

Technical data

Flow rate/pressure characteristic curve at 225 mA

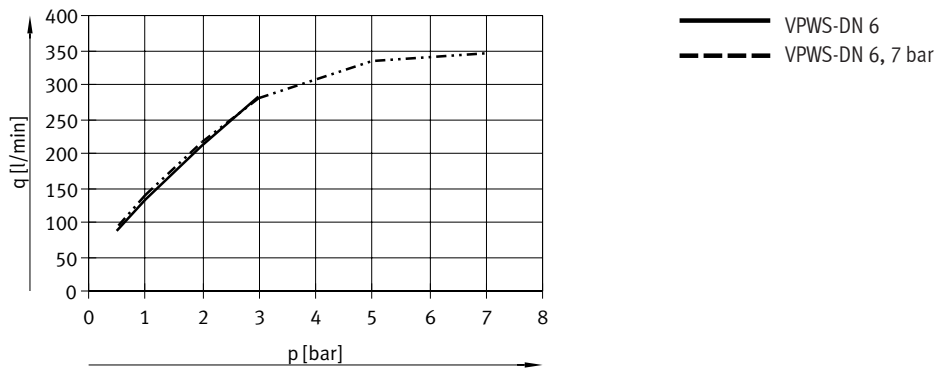

Technical data

Dimensions

Download CAD data → www.festo.com

Proportional directional control valve

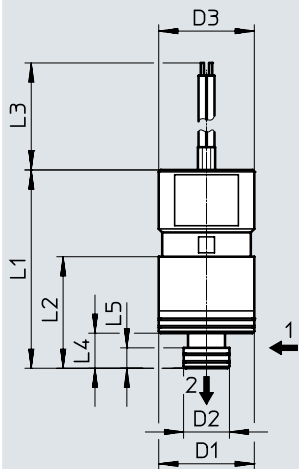

[1] Pneumatic connection 1
(with VPWS-6 as connection 2)

[2] Pneumatic connection 2
(with VPWS-6 as connection 1)

Type	D1 ø	D2 ø	D3 ø	L1	L2	L3	L4	L5
VPWS-1-B-6-PC15-10-V	15	7.2	15	31	17.5	70 ... 80	5.5	3.2
VPWS-1.5-B-6-PC15-8-V	15	7.2	15	31	17.5	70 ... 80	5.5	3.2
VPWS-2.2-B-6-PC15-3-V	15	7.2	15	31	17.5	70 ... 80	5.5	3.2
VPWS-6-B-6-PC15-3-V	15	7.5	15	36.4	22.9	70 ... 80	7.23	2.9
VPWS-6-B-6-PC15-7-V	15	7.5	15	36.4	22.9	70 ... 80	7.23	2.9

Dimensions

Download CAD data → www.festo.com

Manifold block

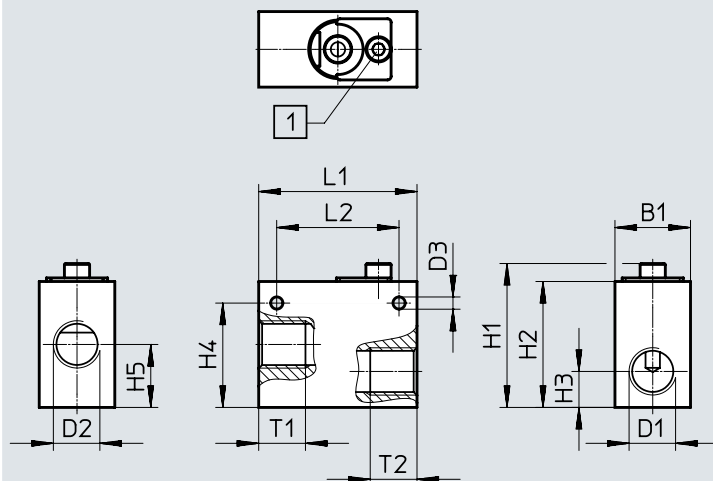

[1] Socket head screw M4X8

Type	B1	D1	D2	D3 ø	H1	H2	H3	H4	H5	L1	L2	T1	T2
VABS-P4-10S-G14	21	G1/4	G1/4	3.4	40	35	10	29	17.5	44	34	13	13
VABS-P4-20S-G38	25	G3/8	G3/8	3.4	47	42	11.5	36	19	44	34	13	13

Technical data

Dimensions

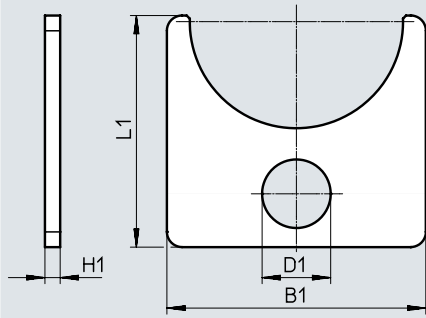

Download CAD data → www.festo.com

Mounting

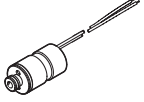
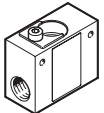

Type	B1	D1	H1	L1
VAME-P4-PC15-P-P10	17	4.5	1	15.2

Ordering data

			Part No.	Type	PU ¹⁾
Proportional directional control valve					
	2/2-way proportional directional control valve, closed	Nominal width 1 mm	8186783	VPWS-1-B-6-PC15-10-V	1
		Nominal width 1.5 mm	8074075	VPWS-1.5-B-6-PC15-8-V	1
		Nominal width 2.2 mm	8074074	VPWS-2.2-B-6-PC15-3-V	1
		Nominal width 6 mm	8074537	VPWS-6-B-6-PC15-3-V	1
		Nominal width 6 mm	8074538	VPWS-6-B-6-PC15-7-V	1
Manifold block					
	Suitable for proportional directional control valves with nominal width 1.5 and 2.2 mm Set for 2/2-way proportional directional control valve VPWS, comprising: <ul style="list-style-type: none"> • Manifold block VABS-P4-10S-G14 • 1 mounting component from the set VAME-P4-PC15-P-P10 • Socket head screw M4x8 	8087327	VABS-P4-10S-G14	1	
		Suitable for proportional directional control valve with nominal width 6 mm Set for 2/2-way proportional directional control valve VPWS, comprising: <ul style="list-style-type: none"> • Manifold block VABS-P4-20S-G38 • 1 mounting component from the set VAME-P4-PC15-P-P10 • Socket head screw M4x8 	8087328	VABS-P4-20S-G38	1
Mounting					
	For 2/2-way proportional directional control valve VPWS in manifold block VABS (set comprises 10 mountings for 10 proportional directional control valves VPWS)	8087347	VAME-P4-PC15-P-P10	1	

1) Packaging unit.

Festo - Your Partner in Automation



1 Festo Inc.
5300 Explorer Drive
Mississauga, ON L4W 5G4
Canada

Festo Customer Interaction Center
Tel: 1 877 463 3786
Fax: 1 877 393 3786
Email: customer.service.ca@festo.com



2 Festo Pneumatic
Av. Ceylán 3,
Col. Tequesquináhuac
54020 Tlalnepantla,
Estado de México

Multinational Contact Center
01 800 337 8669
ventas.mexico@festo.com



3 Festo Corporation
1377 Motor Parkway
Suite 310
Islandia, NY 11749

Festo Customer Interaction Center
1 800 993 3786
1 800 963 3786
customer.service.us@festo.com



4 Regional Service Center
7777 Columbia Road
Mason, OH 45040

Connect with us



www.festo.com/socialmedia



www.festo.com

Subject to change