

Media separated solenoid valves VYKA

FESTO



Key features

Special characteristics

- Very easy to clean thanks to media separation
- Low media consumption thanks to small internal volume
- Materials in contact with the media conform to FDA-listed materials
- Developed according to ISO 13485
- High-quality materials, therefore also suitable for aggressive media
- High flow rate with minimal size (width 7 mm and nominal width 1.2 mm)
- High repetition accuracy, switching frequency and precision, therefore also suitable for extremely small volumes and dosing tasks
- Low power consumption as a result of holding current reduction
- Extremely flexible in use thanks to 3/2-way and 2/2-way variants as well as 12 ... 26 V DC actuation

Function

The media separated solenoid valve VYKA is designed for installation in laboratory devices. The valve is used to control gaseous and liquid media within the limits of the technical data. The chemical resistance of the valve materials coming into contact with the media must be checked for each application. The user is responsible for validating the application.

The valve VYKA is a directly actuated directional control valve with solenoid coil. In a de-energised state, the valve automatically returns to its normal position. Normally closed and normally open variants are available. The solenoid valve VYKA is additionally available in variants with or without vacuum technology.

Note

The valve uses FDA-listed materials but is not a food materials article in the sense of Regulation (EC) 1935/2004. Country-specific regulations in respect of food contact must be taken into account.

Configuration

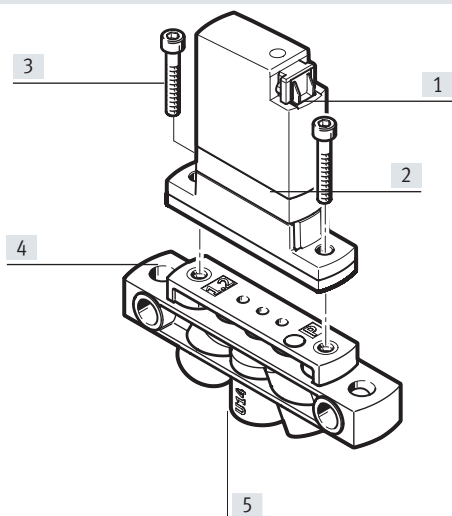

- [1] Terminal contact for E-box VAVE or connecting cable NEBV
- [2] Solenoid valve
- [3] Screws for mounting on the sub-base (included in the scope of delivery of the valves)
- [4] Sub-base VABS
- [5] Media connections

Key features

Actuation

-  - Note

The solenoid valve VYKA is controlled by a constant current source. A holding current reduction is essential as otherwise the valve will significantly heat up. A holding current reduction can be achieved as follows:

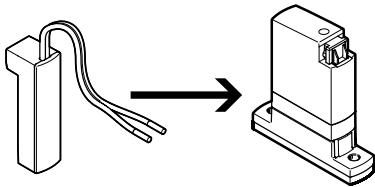

When using E-box VAVE, holding current reduction is integrated (recommended).

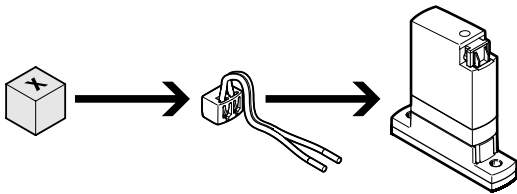

When using connecting cable NEBV, a separate means of holding current reduction must be provided by the customer.

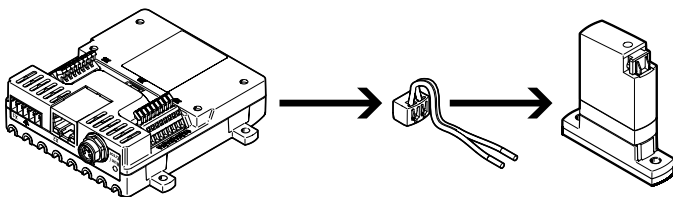

The valve control module VAEM together with the connecting cable NEBV (recommended) offers the option of actuation with holding current reduction.

Product range overview

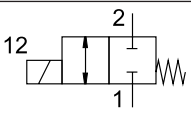
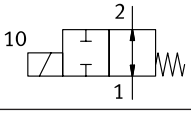
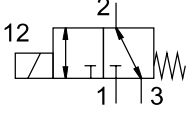
Function	Circuit symbol	Type	Valve function	Flow rate Kv				Operating voltage In combination with VAVE-K1	→ Page/ Internet
				Without vacuum technology		With vacuum technology			
				[m ³ /h]	[l/min]	[m ³ /h]	[l/min]		
Media separated solenoid valve	Rocker valve with diaphragm seal								
		VYKA-F7-M22C	2/2-way solenoid valve: • Single solenoid • Normally closed	0.013	0.22	0.018	0.3	12 ... 26 V DC	7
		VYKA-F7-M22U	2/2-way solenoid valve: • Single solenoid • Normally open	0.013	0.22	0.018	0.3	12 ... 26 V DC	7
		VYKA-F7-M32	3/2-way solenoid valve: • Single solenoid • Normally closed/open	0.021	0.35	0.021	0.35	12 ... 26 V DC	7

Type codes

001	Series		
VYKA	Solenoid valve VYKA		
002	Directional control valve type		
F	Flanged valve		
003	Size		
7	Size 7		
004	Valve function		
M22C	2/2-way valve, normally closed		
M22U	2/2-way valve, normally open		
M32	3/2-way valve, normally closed or open		
005	Nominal width		
12	1.2 mm		
006	Pressure range [bar]		
D2	0 ... 2		
	Standard		
007	Housing material		
P	PEEK		
008	Diaphragm and sealing material		
E	EPDM		
F	FFPM		
V	FPM		
009	Nominal operating voltage		
5Y	12 V DC to 26 V DC		
010	Electrical connection		
Q7	Plug socket, connection pattern Q		

Peripherals overview

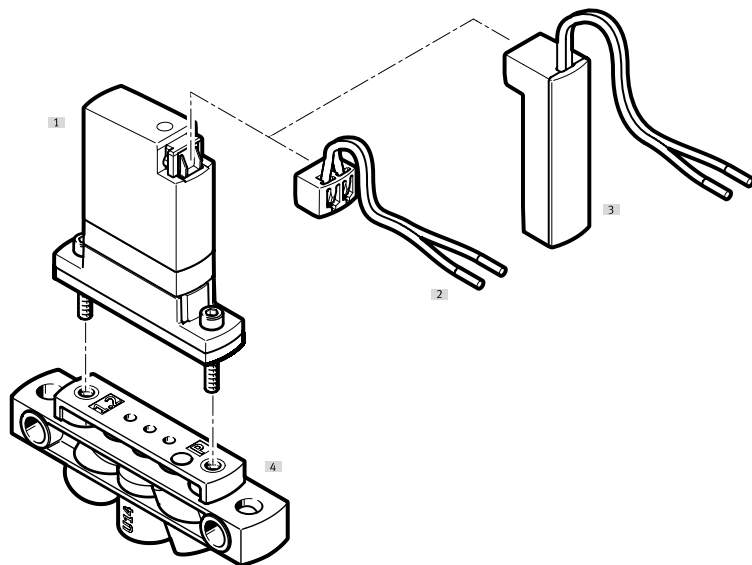

Accessories

	Type/order code	Description	→ Page/Internet
[1]	VYKA	Solenoid valve	13
[4]	NEBV	Connecting cable	13
[3]	VAVE	E-box	13
[2]	VABS	Sub-base	13

Datasheet

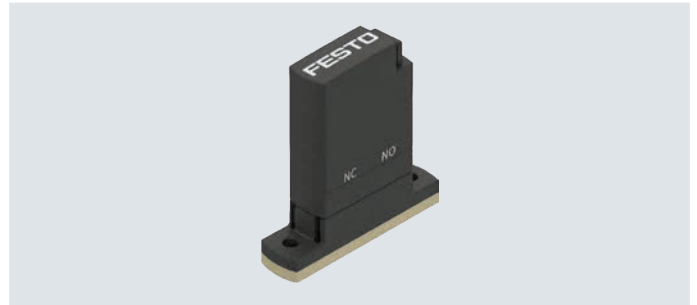
-  - 7 mm-  - Flow rateWithout vacuum: 0.013 ... 0.021 m³/hWith vacuum: 0.018 ... 0.021 m³/h

General technical data				
Valve function			2/2-way, single solenoid, closed 2/2-way, single solenoid, open 3/2-way, single solenoid, open/closed	
Design			Rocker valve with diaphragm seal	
Reset method			Mechanical spring	
Size			7	
Nominal width		[mm]	1.2	
Grid dimension		[mm]	7.5	
Fluid connection			Flange	
Standard nominal flow rate	VYKA-F7-M22C	[l/min]	7.2	
	VYKA-F7-M22U		7	
	VYKA-F7-M32		11	
Note on standard nominal flow rate			With a pressure drop 1 -> 0 bar (gas)	
Flow rate Kv	2/2-way valve without vacuum	[m ³ /h] [l/min]	0.013 0.22	
	3/2-way valve without vacuum	[m ³ /h] [l/min]	0.021 0.35	
	2/2-way valve with vacuum	[m ³ /h] [l/min]	0.018 0.3	
	3/2-way valve with vacuum	[m ³ /h] [l/min]	0.021 0.35	
	Note on flow rate Kv			For water as medium Pressure difference 1 bar
	Water flow rate at max. operating pressure	2/2-way valve without vacuum	[m ³ /h] [l/min]	0.018 0.3
3/2-way valve without vacuum		[m ³ /h] [l/min]	0.03 0.5	
2/2-way valve with vacuum		[m ³ /h] [l/min]	0.027 0.45	
3/2-way valve with vacuum		[m ³ /h] [l/min]	0.03 0.5	
Internal volume		2/2-way valve without vacuum		15 µl fluid chamber valve 21 µl valve with fluid connections
		3/2-way valve without vacuum		16 µl fluid chamber valve 26 µl valve with fluid connections
	2/2-way valve with vacuum		18 µl fluid chamber valve 24 µl valve with fluid connections	
	3/2-way valve with vacuum		16 µl fluid chamber valve 26 µl valve with fluid connections	

Datasheet

General technical data	
Sealing principle	Soft
Direction of flow	Reversible with restrictions
Actuation type	Electrical
Type of actuation	Direct
Manual override	None
Type of mounting	With through-hole for M2 screw
Mounting position	Any
Degree of protection	IP40
Note on degree of protection	In mounted state
Application information	For indoor use only
Corrosion resistance class	0
Product weight	[g] 10.9

Electrical data		
In combination with VAVE		
Operating voltage range	[V DC] 12 ... 26	
Note on operating voltage range	With E-box VAVE-K1-...	
Permissible voltage fluctuations	[%] ±10	
Electrical connection 1	Connection type	Socket
	Connection technology	Plug pattern Q7
	Number of pins/cores	2
Insulation class	B	
Electrical power consumption	[W] 3.5	
Note on power consumption	Low-current phase 0.3 W, high-current phase 3.5 W for 60 ms, in combination with VAVE-K1-...	
Characteristic coil data	12 ... 26 V DC: low-current phase 0.06 W, high-current phase 2.2 W	
Duty cycle	[%] 100, in combination with holding current reduction	
	Observe notes on operating the solenoid valves	
Plug connector NEBV when using an individual constant-current source		
Inrush current	[mA] 300 for 60 ms	
Holding current	[mA] 50	
Permissible energy fluctuations	[%] ± 2	

Switching time		2/2-way valve			3/2-way valve		
		Diaphragm material FFPM	Diaphragm material FPM	Diaphragm material EPDM	Diaphragm material FFPM	Diaphragm material FPM	Diaphragm material EPDM
Switching time for gaseous media	On	[ms] 6	5	5	5	5	5
	Off	[ms] 6	–	–	5	5	5
Switching time for liquid media	On	[ms] 5	5	5	5	5	5
	Off	[ms] 7	–	–	6	5	5

Switching frequency		Ambient temperature			
		< 20°C	20 ... 30°C	30 ... 40°C	40 ... 50°C
Maximum switching frequency	Individual valve	[Hz] 6	5	4	3
	Manifold assembly ¹⁾	[Hz] 2	1.5	1	0.5
Note on switching frequency		Dependent on the ambient temperature and installation state			
		For 100% duty cycle, dependent on the ambient temperature and installation state. For duty cycle <100%, higher switching frequencies are possible.			

1) Space between two valves: < 7.5 mm

Datasheet

Operating and environmental conditions, solenoid valve without vacuum technology			
		2/2-way valve Diaphragm material FFPM	3/2-way valve Diaphragm material FFPM
Medium		Liquid media	Liquid media
		Gaseous media	Gaseous media
Note on the medium		Note resistance of materials in contact with the media	Note resistance of materials in contact with the media
		Maximum particle size 5 µm	Maximum particle size 5 µm
Temperature of gaseous media	[°C]	15 ... 50	15 ... 50
Temperature of liquid media	[°C]	15 ... 50	15 ... 50
Ambient temperature	[°C]	15 ... 50	15 ... 50
Storage temperature	[°C]	-20 ... 70	-20 ... 70
Pressure of medium	[MPa]	0 ... 0.2	0 ... 0.2
	[bar]	0 ... 2	0 ... 2
	[psi]	0 ... 29	0 ... 29
Pressure of medium, reversible	[MPa]	0 ... 0.1	0 ... 0.1
	[bar]	0 ... 1	0 ... 1
	[psi]	0 ... 14.5	0 ... 14.5
Note on pressure of medium	[MPa]	IN: 0 ... 0.2	COM: 0 ... 0.2
	[bar]	IN: 0 ... 2	COM: 0 ... 2
	[psi]	IN: 0 ... 29	COM: 0 ... 29
	[MPa]	OUT: 0 ... 0.1	NC: 0 ... 0.1
	[bar]	OUT: 0 ... 1	NC: 0 ... 1
	[psi]	OUT: 0 ... 14.5	NC: 0 ... 14.5
	[MPa]	–	NO: 0 ... 0.1
[bar]	–	NO: 0 ... 1	
Burst pressure	[MPa]	2.3	2.3
	[bar]	23	23
	[psi]	333.5	333.5

Datasheet

Operating and environmental conditions, solenoid valve with vacuum technology		2/2-way valve		3/2-way valve	
		Diaphragm material FPM	Diaphragm material EPDM	Diaphragm material FPM	Diaphragm material EPDM
Medium		Liquid media	Liquid media	Liquid media	Liquid media
		Gaseous media	Gaseous media	Gaseous media	Gaseous media
Note on the medium		Note resistance of materials in contact with the media	Note resistance of materials in contact with the media	Note resistance of materials in contact with the media	Note resistance of materials in contact with the media
		Maximum particle size 5 µm	Maximum particle size 5 µm	Maximum particle size 5 µm	Maximum particle size 5 µm
Temperature of gaseous media	[°C]	0 ... 50	0 ... 50	0 ... 50	0 ... 50
Temperature of liquid media	[°C]	0 ... 50	0 ... 50	0 ... 50	0 ... 50
Ambient temperature	[°C]	0 ... 50	0 ... 50	0 ... 50	0 ... 50
Storage temperature	[°C]	-20 ... +70	-20 ... +70	-20 ... +70	-20 ... +70
Pressure of medium	[MPa]	-0.05 ... 0.2	-0.05 ... 0.2	-0.05 ... 0.2	-0.05 ... 0.2
	[bar]	-0.5 ... 2	-0.5 ... 2	-0.5 ... 2	-0.5 ... 2
	[psi]	-7.25 ... 29	-7.25 ... 29	-7.25 ... 29	-7.25 ... 29
Note on pressure of medium	[MPa]	IN: -0.025 ... 0.2	IN: -0.025 ... 0.2	COM: -0.025 ... 0.2	COM: -0.025 ... 0.2
	[bar]	IN: -0.25 ... 2	IN: -0.25 ... 2	COM: -0.25 ... 2	COM: -0.25 ... 2
	[psi]	IN: -3.625 ... 29	IN: -3.625 ... 29	COM: -3.625 ... 29	COM: -3.625 ... 29
	[MPa]	OUT: -0.05 ... 0.1	OUT: -0.05 ... 0.1	NC: -0.05 ... 0.1	NC: -0.05 ... 0.1
	[bar]	OUT: -0.5 ... 1	OUT: -0.5 ... 1	NC: -0.5 ... 1	NC: -0.5 ... 1
	[psi]	OUT: -7.25 ... 14.5	OUT: -7.25 ... 14.5	NC: -7.25 ... 14.5	NC: -7.25 ... 14.5
	[MPa]	-	-	NO: -0.05 ... 0.1	NO: -0.05 ... 0.1
	[bar]	-	-	NO: -0.5 ... 1	NO: -0.5 ... 1
	[psi]	-	-	NO: -7.25 ... 14.5	NO: -7.25 ... 14.5
	Burst pressure	[MPa]	2.3	2.3	2.3
[bar]		23	23	23	23
[psi]		333.5	333.5	333.5	333.5

Information on materials		
Materials in contact with the media	All types	PEEK
	VYKA-...-PF	FFPM
	VYKA-...-PV	FPM
	VYKA-...-PE	EPDM
Food-safe		See supplementary material information
Housing material		Reinforced PA
		PEEK
		Reinforced PPA
Diaphragm material	VYKA-...-PF	FFPM
	VYKA-...-PV	FPM
	VYKA-...-PE	EPDM
Sealing material	VYKA-...-PF	FFPM
	VYKA-...-PV	FPM
	VYKA-...-PE	EPDM
Material of sub-base VABS		PEEK
Note on materials		RoHS-compliant
LABS (PWIS) conformity		VDMA24364 zone III

Datasheet

Dimensions

Download CAD data → www.festo.com

Solenoid valve

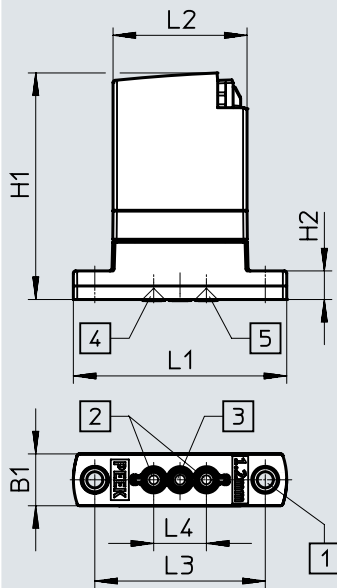

- [1] Mounting holes, screws supplied for threaded hole M2
- [2] Fluid connection
- [3] COM port (only 3/2-way variants)
- [4] Valve inlet only for VYKA-F7-M22U
- [5] Valve inlet only for VYKA-F7-M22C

Type	B1	H1	H2	L1	L2	L3 ± 0.1	L4 ± 0.1
VYKA-...	7	30	3.8	28.4	17.8	22.7	7

Datasheet

Dimensions

Download CAD data → www.festo.com

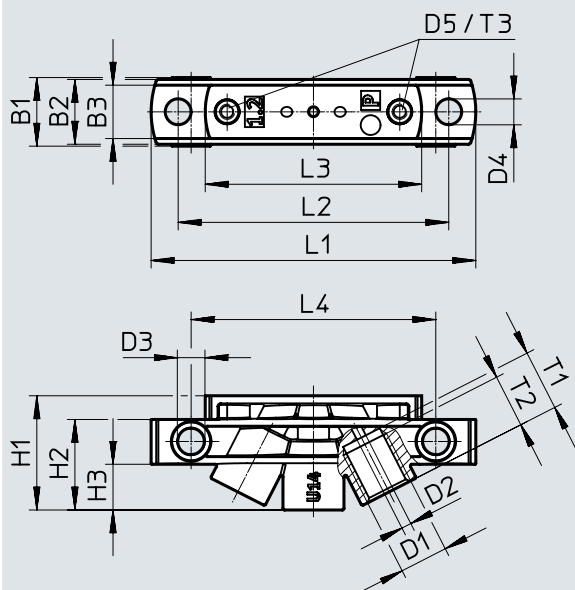

Terminal strip



Type	B1	B2	B3	D1	D2	D3	D4	D5
VABS-K1-7B-12-U14-P	9	8.5	7	UNF 1/4-28	1.3	3.6	3.4	M2
VABS-K1-7B-12-M5-P				M5				

Type	H1	H2	H3	L1	L2	L3	L4	T1	T2	T3
VABS-K1-7B-12-U14-P	15	11.9	6	42.6	35.5	28.4	32.1	8	7	5
VABS-K1-7B-12-M5-P										

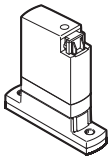
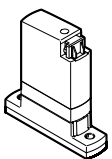
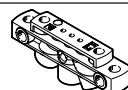
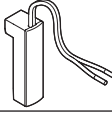
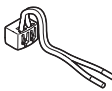
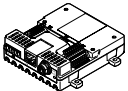
Accessories

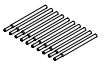
Ordering data		Description	Part no.	Type		
Solenoid valve, without vacuum technology						
	2/2-way valve, normally closed	Diaphragm and sealing material FPM	8114566	VYKA-F7-M22C-12-D2-PF-5YQ7		
	2/2-way valve, normally open	Diaphragm and sealing material FPM	8114568	VYKA-F7-M22U-12-D2-PF-5YQ7		
	3/2-way valve, normally closed or open	Diaphragm and sealing material FPM	8114564	VYKA-F7-M32-12-D2-PF-5YQ7		
Solenoid valve, with vacuum technology						
	2/2-way valve, normally closed	Diaphragm and sealing material FPM	8170087	VYKA-F7-M22C-12-PV-5YQ7		
		Diaphragm and sealing material EPDM	8170088	VYKA-F7-M22C-12-PE-5YQ7		
	2/2-way valve, normally open	Diaphragm and sealing material FPM	8170090	VYKA-F7-M22U-12-PV-5YQ7		
		Diaphragm and sealing material EPDM	8170091	VYKA-F7-M22U-12-PE-5YQ7		
	3/2-way valve, normally closed or open	Diaphragm and sealing material FPM	8170084	VYKA-F7-M32-12-PV-5YQ7		
		Diaphragm and sealing material EPDM	8170085	VYKA-F7-M32-12-PE-5YQ7		
Sub-base						
	Female thread M5	Nominal width 1.2 mm	8047064	VABS-K1-7B-12-M5-P		
	Female thread 1/4-28 UNF	Nominal width 1.2 mm	8047063	VABS-K1-7B-12-U14-P		
E-box						
	Straight socket, plug pattern Q7, with holding current reduction		8115100	VAVE-K1-7-5YL1-LR		
Connecting cable						
	Straight socket, plug pattern Q7	Cable length 0.1 m	8115892	NEBV-Q7G2-PD-0.1-N-LE2		
		Cable length 0.5 m	8115099	NEBV-Q7G2-PD-0.5-N-LE2		
Valve control module						
	For up to 8 solenoid valves		8088772	VAEM-V-S8EPRS2		
Push-in fitting						
	Male thread M5	For tubing O.D. 4 mm	8085657	NPQR-DK-M5-Q4		
		For tubing O.D. 6 mm	8085659	NPQR-DK-M5-Q6		
Ordering data						
Ordering data		Description	Part no.	Type	PU ¹⁾	
Fitting						
	Male thread 1/4-28 UNF	For tubing I.D. 1.2 mm	8104288	NLFA-D-U14-B1.2-PP-P10	10	
		For tubing O.D. 1.6 mm	8104285	NLFA-D-U14-K1.6-PP-P10	10	
		For tubing I.D. 2.1 mm	8104289	NLFA-D-U14-B2.1-PP-P10	10	
		For tubing O.D. 3.0 mm	8104286	NLFA-D-U14-K3-PP-P10	10	
		For tubing O.D. 3.2 mm	8104287	NLFA-D-U14-K3.2-PP-P10	10	
Dosing nozzles						
	Dosing needle set	Dosing needle 30 mm	Nominal width 0.3 mm	8104295	VAVN-N-A1.6-03-30-F-V1-P10	10
				8104294	VAVN-N-A1.6-03-30-V-V1-P10	10
		Dosing needle 60 mm	Nominal width 0.3 mm	8104298	VAVN-N-A1.6-03-60-F-V1-P10	10
				8104297	VAVN-N-A1.6-03-60-V-V1-P10	10
		Dosing needle 30 mm	Nominal width 0.6 mm	8104290	VAVN-N-A1.6-06-30-V1-P10	10
				8104296	VAVN-N-A1.6-06-30-V-V1-P10	10
		Dosing needle 60 mm	Nominal width 0.6 mm	8104292	VAVN-N-A1.6-06-60-V1-P10	10
				8104299	VAVN-N-A1.6-06-60-V-V1-P10	10
		Dosing needle 30 mm	Nominal width 1.2 mm	8104291	VAVN-N-A1.6-12-30-V1-P10	10
				8104293	VAVN-N-A1.6-12-60-V1-P10	10

1) Packaging unit

Festo - Your Partner in Automation



1 Festo Inc.
5300 Explorer Drive
Mississauga, ON L4W 5G4
Canada

Festo Customer Interaction Center
Tel: 1 877 463 3786
Fax: 1 877 393 3786
Email: customer.service.ca@festo.com



2 Festo Pneumatic
Av. Ceylán 3,
Col. Tequesquináhuac
54020 Tlalnepantla,
Estado de México

Multinational Contact Center
01 800 337 8669
ventas.mexico@festo.com



3 Festo Corporation
1377 Motor Parkway
Suite 310
Islandia, NY 11749

Festo Customer Interaction Center
1 800 993 3786
1 800 963 3786
customer.service.us@festo.com



4 Regional Service Center
7777 Columbia Road
Mason, OH 45040

Connect with us



www.festo.com/socialmedia



www.festo.com

Subject to change