

F4T Controller Installation and Troubleshooting User's Guide



1241 Bundy Boulevard., Winona, Minnesota USA 55987
Phone: +1 (507) 454-5300, Fax: +1 (507) 452-4507
<http://www.watlow.com/F4T>

1720-6742 Rev. A



January 2019

Made in the U.S.A.

Safety Information

We use note, caution and warning symbols throughout this document to draw your attention to important operational and safety information.









A “NOTE” marks a short message to alert you to an important detail.

A “CAUTION” safety alert appears with information that is important for protecting your equipment and performance. Be especially careful to read and follow all cautions that apply to your application.

A “WARNING” safety alert appears with information that is important for protecting you, others and equipment from damage. Pay very close attention to all warnings that apply to your application.

The safety alert symbol, (an exclamation point in a triangle ) precedes a general CAUTION or WARNING statement.

The electrical hazard symbol, (a lightning bolt in a triangle ) precedes an electric shock hazard CAUTION or WARNING safety statement. Further explanations follow:

Symbol	Explanation
 CAUTION WARNING or  Electrical Shock Hazard	<p>CAUTION: Warning or Electrical Hazard that needs further explanation than label on unit can provide. Consult QSG for further information.</p> <p>AVERTISSEMENT: mise en garde ou danger qui demande plus de précisions que l'information sur l'étiquette de l'unité. Consultez le manuel de l'utilisateur pour plus d'informations.</p>
	Unit can be powered with either alternating current (ac) voltage or direct current (dc) voltage.
	ESD Sensitive product, use proper grounding and handling techniques when installing or servicing product.
	Do not throw in trash, use proper recycling techniques or consult manufacturer for proper disposal.
 PC	Enclosure made of Polycarbonate material. Use proper recycling techniques or consult manufacturer for proper disposal.
	Unit is a Listed device per Underwriters Laboratories®. It has been evaluated to United States and Canadian requirements for Process Control Equipment. CSA 22.2#14, File 158031, UL 61010, File E185611 QUYX, QUYX7. . See: www.ul.com
	Unit is compliant with European Union directives. See Declaration of Conformity for further details on Directives and Standards used for Compliance.
	Unit has been reviewed and approved by Factory Mutual as a Temperature Limit Device per FM Class 3545 standard. See: www.fmglobal.com

Symbol	Explanation
	Unit has been reviewed and approved by CSA International for use as Temperature Indicating-Regulating Equipment per CSA C22.2 No. 24. See: www.csagroup.org

This F4T User's Guide is copyrighted by Watlow Electric Manufacturing Company, © May 2016 with all rights reserved.

- © 2010-2012, QNX Software Systems Limited. All rights reserved.
- © 2008 -2014, Crank Software Inc. All rights reserved.
- Watlow® and TRU-TUNE® are registered trademarks of Watlow Electric Manufacturing Company.
- UL® is a registered trademark of Underwriter's Laboratories Incorporated.
- Modbus® is a registered trademark of Schneider Automation Incorporated.
- Vaisala® is a registered trademark of Vaisala OY Corporation.
- Microsoft® and Windows® are registered trademarks of the Microsoft Corporation.
- Quencharc® is a registered trademark of ITW Paktron.



Table of Contents

- Chapter 1: Overview 2**
 - Available F4T Literature and Resources 2

- Chapter 2: Install and Wire 4**
 - Getting Started Quickly...The Logical Approach 4
 - Dimensions. 4
 - Installing the F4T 5
 - Panel Mounting the Base. 5
 - Flush Mounting the Base. 6
 - Electrical Isolation 8
 - Wiring the F4T Base 8
 - Power Requirements 9
 - Flex Module (FM) Characteristics 9
 - Flex Module Installation 9
 - Wiring the Modules 10
 - Communications Connections. 24

- Chapter 3: Connecting a PC 25**
 - Using the User Interface (UI) to Change or View Ethernet Settings . . . 25
 - Understanding the Front Panel Navigational Buttons 25
 - Connecting the F4T Base to a PC 27
 - DHCP Connection 27
 - Fixed IP Connection. 27
 - Composer Software. 28
 - Starting Composer Software 28
 - Verifying Pluggable Flex Module Installation Using Composer . . . 28

- Chapter 4: Calibration 30**
 - Calibrating the F4T Inputs 30
 - Required Equipment When Performing Calibration 30
 - Calibration of Analog Inputs. 31
 - Using Composer Software to Calibrate Analog Inputs 32
 - Using the User Interface to Calibrate Analog Inputs. 32

- Chapter 5: Troubleshooting 33**
 - Replacing the Battery 39

- Chapter 6: Appendix 41**
 - F4T Base Specifications 41
 - F4T Base Ordering Information 44
 - Flex Modules and Limit I/O Specifications 45
 - Flex Module - Mixed I/O Ordering Information 48
 - Flex Module - Limit Ordering Information 49
 - Flex Modules - High Density I/O Specifications 49
 - Flex Module - High Density Ordering Information. 53
 - Flex Module - Communications Ordering Information 53
 - How to Reach Us 56

1

Chapter 1: Overview

Available F4T Literature and Resources

Document Title and Part Number	Description
F4T Setup and Operation User Guide, part number: 1680-2414 Rev. A	This document looks deeper at the system configuration using Composer™ software and the F4T function blocks and their connections. Common product usage is described and illustrated through application examples.
F4T Specification Sheet, part number: WIN-F4T-1118	Describes F4T hardware options, features, benefits and technical specifications.
Watlow Application Guide	Comprehensive guide to understanding thermal principles, electrical noise, best practises for wiring industrial controls and much more.
Watlow Support Tools DVD, part number: 0601-0001-0000	Contains all related user documents, tutorial videos, application notes and the application guide described above.

To acquire one or more of these documents navigate to the Watlow website where you will have a choice to download free copies or purchase printed versions. Click on the link below to find your document of choice: <http://www.watlow.com/F4T>. For the Application Guide, click here: <http://www.watlow.com/common/catalogs/files/appguide.pdf>

Your Comments are Appreciated

In an effort to continually improve our technical literature and ensuring that we are providing information that is useful to you, we would very much appreciate your comments and suggestions. Please send any comments you may have to the following e-mail address: TechlitComments@watlow.com

Technical Assistance

If you encounter a problem with your Watlow controller, review your configuration information to verify that your selections are consistent with your application: inputs, outputs, alarms, limits, etc. If the problem persists, you should first contact the Original Equipment Manufacturer (OEM) for assistance. If that is not an option you can also get assistance directly from Watlow:

- Contact a local representative: see last page
- Email: wintechsupport@watlow.com
- Call: 1-800-4WATLOW (1-800-492-8569) or +1 (507) 494-5656 from 7 a.m. to 5 p.m. Central Standard Time (CST) (Select options for Controls & Software and Technical Support)

Please have the following information available when calling:

- Complete model number
- User's Guide
- All configuration information

Warranty

This product is warranted by Watlow for a period of 36 months in accordance with the terms and conditions set forth on Watlow's website which can be accessed at www.watlow.com/terms.

Return Material Authorization (RMA)

1. Call Watlow Customer Service, (507) 454-5300, for a Return Material Authorization (RMA) number before returning any item for repair. If you do not know why the product failed, contact an Application Engineer or Product Manager. All RMA's require:
 - Ship-to address
 - Bill-to address
 - Contact name
 - Phone number
 - Method of return shipment
 - Your P.O. number
 - Detailed description of the problem
 - Any special instructions
 - Name and phone number of person returning the product.
 2. Prior approval and an RMA number from the Customer Service Department is required when returning any product. Make sure the RMA number is on the outside of the carton and on all paperwork returned. Ship on a Freight Prepaid basis.
 3. After we receive your return, we will examine it to verify the reason for the product failure. Unless otherwise agreed to in writing, Watlow's standard warranty provisions, which can be located at www.watlow.com/terms, will apply to any failed product.
 4. In the event that the product is not subject to an applicable warranty, we will quote repair costs to you and request a purchase order from you prior to proceeding with the repair work.
 5. Watlow reserves the right to charge for no trouble found (NTF) returns.
-

Document Overview and Purpose

The purpose of this document is to assist the installer in providing necessary information to mount, wire and power up the F4T controller. This document also provides information to assist in the process of diagnosing problems which might occur during or after the installation process.

2

Chapter 2: Install and Wire

Getting Started Quickly...The Logical Approach

The steps below outline installation and wiring for the base alone. More detail for each is provided in the following sections.

1. Using this document for orientation, find the base part number and note any installed options as well as input voltage requirements.
2. Mount/install the base in the panel (see instructions below for [panel mount](#) or [flush mount](#) options).
3. Ensure that incoming power is off and connect to the base power supply connector (see section "[Wiring the F4T Base](#)").
4. Make note of any I/O module slot dependencies installing each one into an appropriate base slot (see graphic entitled [F4T Slot Dependencies](#) under "Flex Module Installation").
5. Connect the wires from each field device to the associated I/O module connector (see section "[Wiring the Modules](#)").
6. Insert all wired I/O connectors onto the applicable modules and apply power to the base.
7. Connect the controller to a computer running Composer™ software using an Ethernet cable (see section "[Connecting the F4T Base to a PC](#)").

Dimensions

Panel Mount

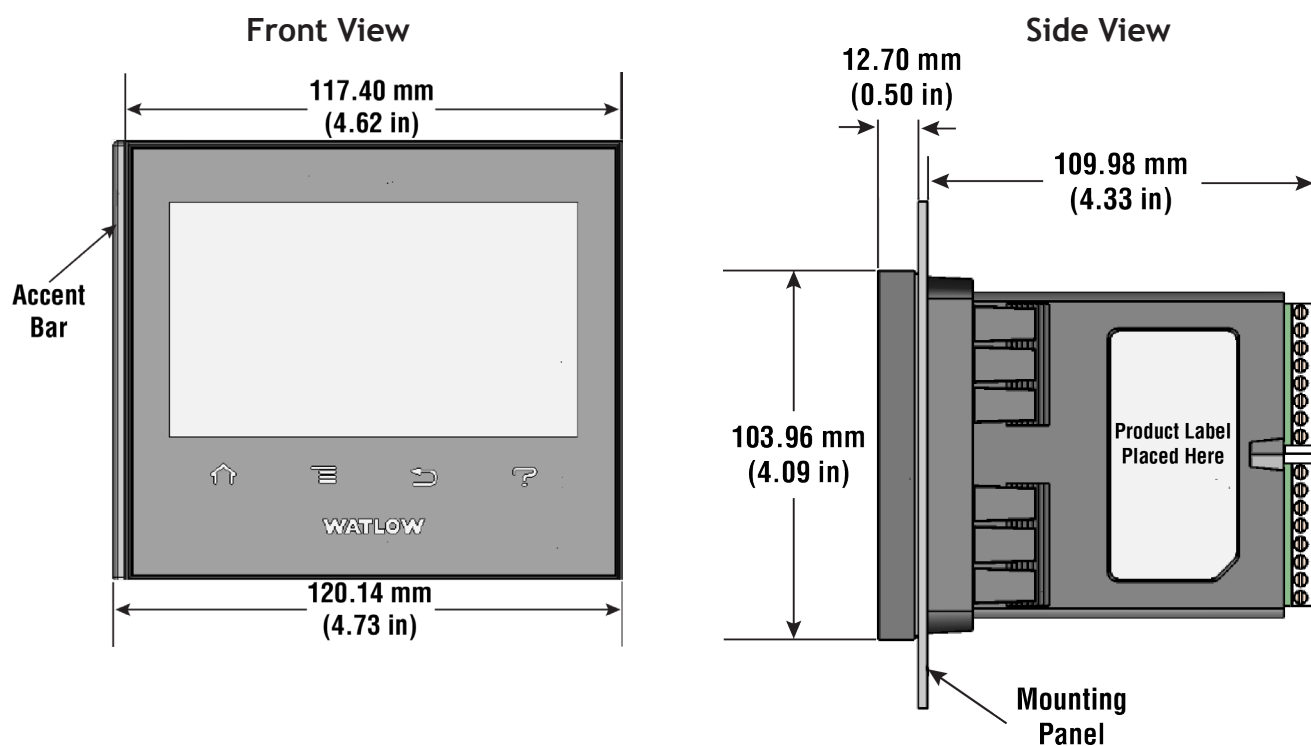

Dimensions (cont.)

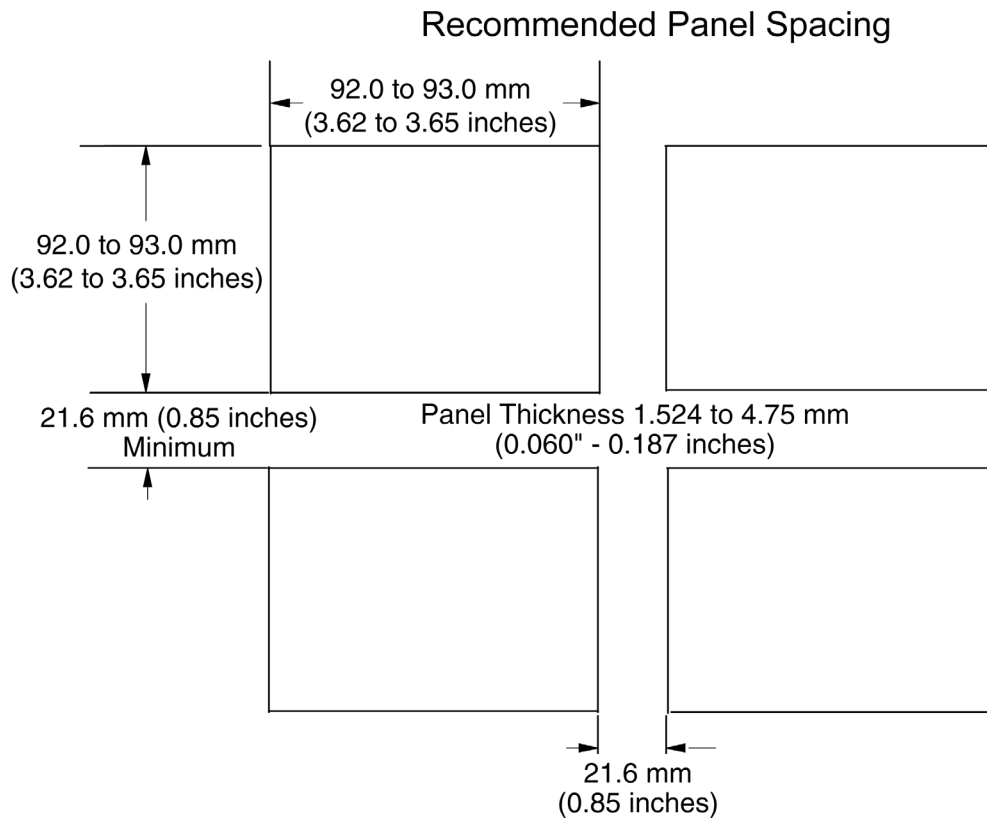

Installing the F4T

Panel Mounting the Base

1. Make the panel cutout using the mounting template dimensions above and insert the case assembly into the panel cutout.
2. While pressing the case assembly firmly against the panel, slide the Retention Collar over the back of the controller until the gasket is compressed.
3. For an IP65 seal, alternately place and push the blade of a screwdriver against each of the the four corners of the retention collar assembly. Apply pressure to the face of the controller while pushing with the screwdriver. Don't be afraid to apply enough pressure to properly install the controller. The seal system is compressed more by mating the retention collar tighter to the front panel. If you can move the case assembly back and forth in the cutout, you do not have a proper seal. The tabs on each side of the retention collar have teeth that latch into the ridges on the sides of the controller. Each tooth is staggered at a different depth from the front so that only one of the tabs, on each side, is locked onto the ridges at a time.

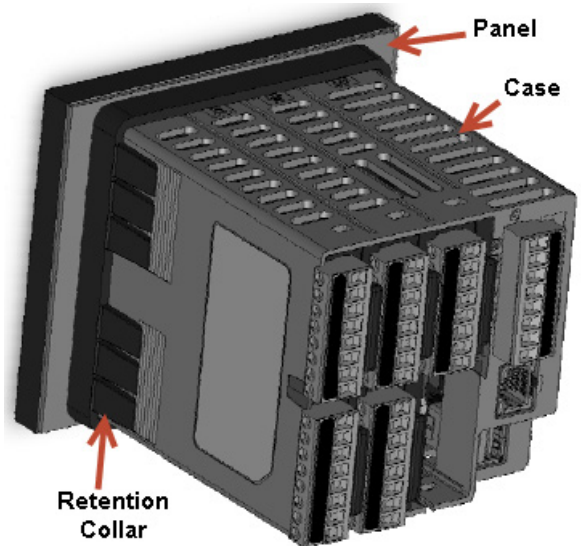

Dimensions (cont.)

Flush Mounting the Base

1. Fabricate the mounting panel per the flush mount vertical or horizontal panel template (shown below).
2. Press PEM standoffs (based on panel material) into mounting panel per supplier recommendations.

PEM Standoffs				
PEM P/N	S0-632-6 Z1	S0S-632-6	S0A-632-6	S04-632-6
Material	Steel (Zinc Plated)	Stainless Steel	Aluminum	Hardened Stainless Steel

3. Insert the controller through the flush mount bracket and lock it in place with the retention collar.
4. Mount flush mount bracket to back panel with (6) #6-32 screws.
5. Apply overlay to front panel.

Note:

Overlay is provided by the user.

Panel Flush Mount with Horizontal Bracket

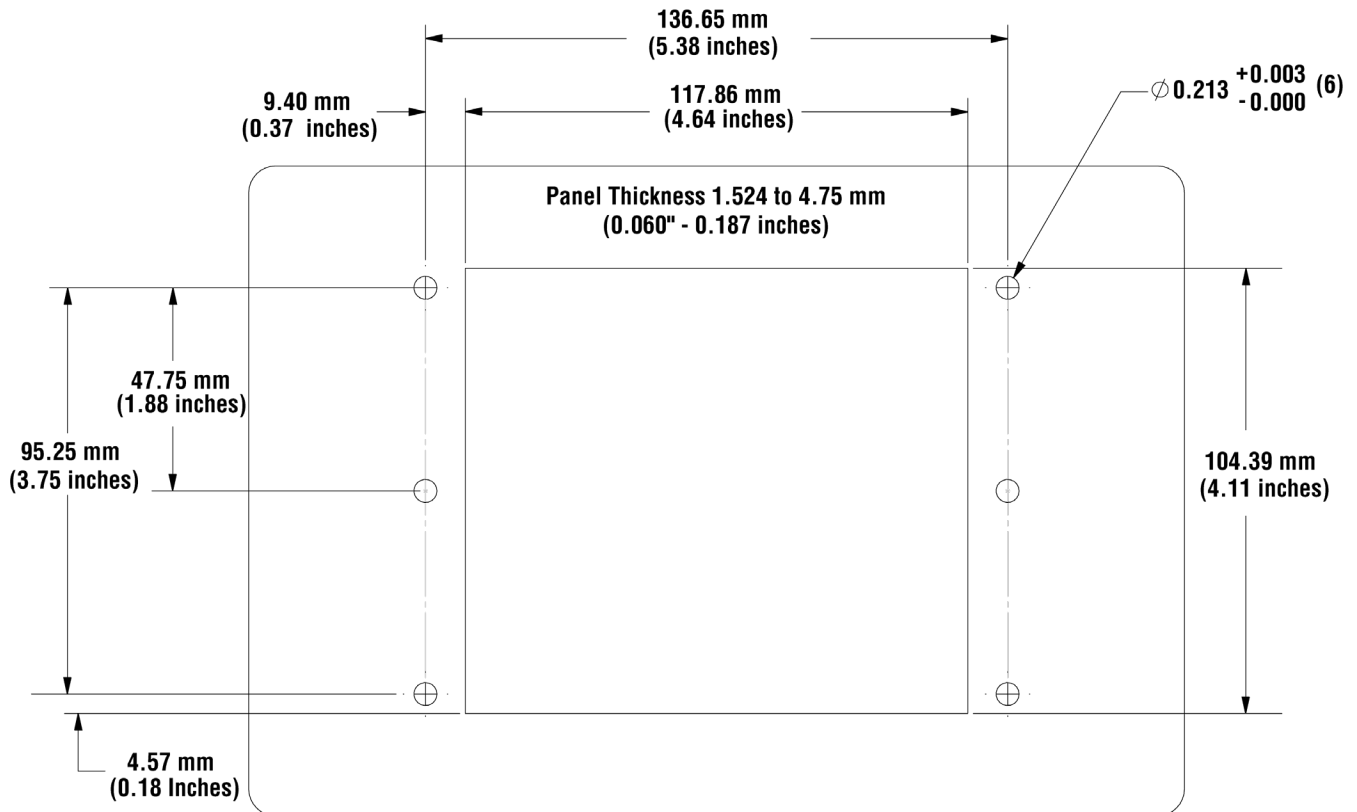

Dimensions (cont.)

Panel Flush Mount with Vertical Bracket

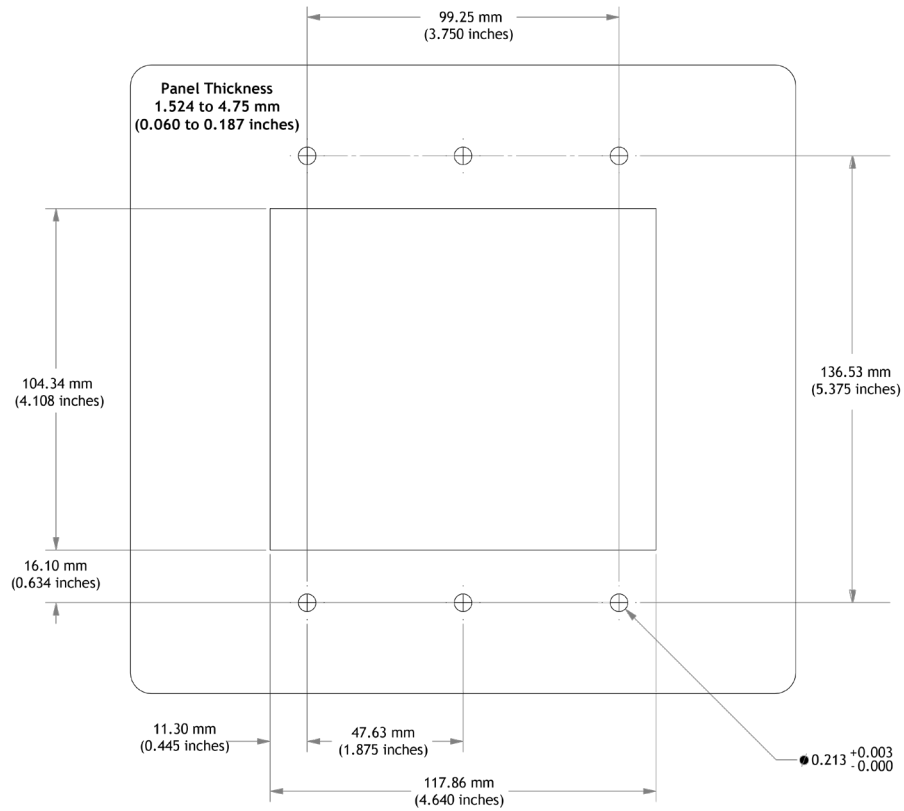

Flush Mount Assembly

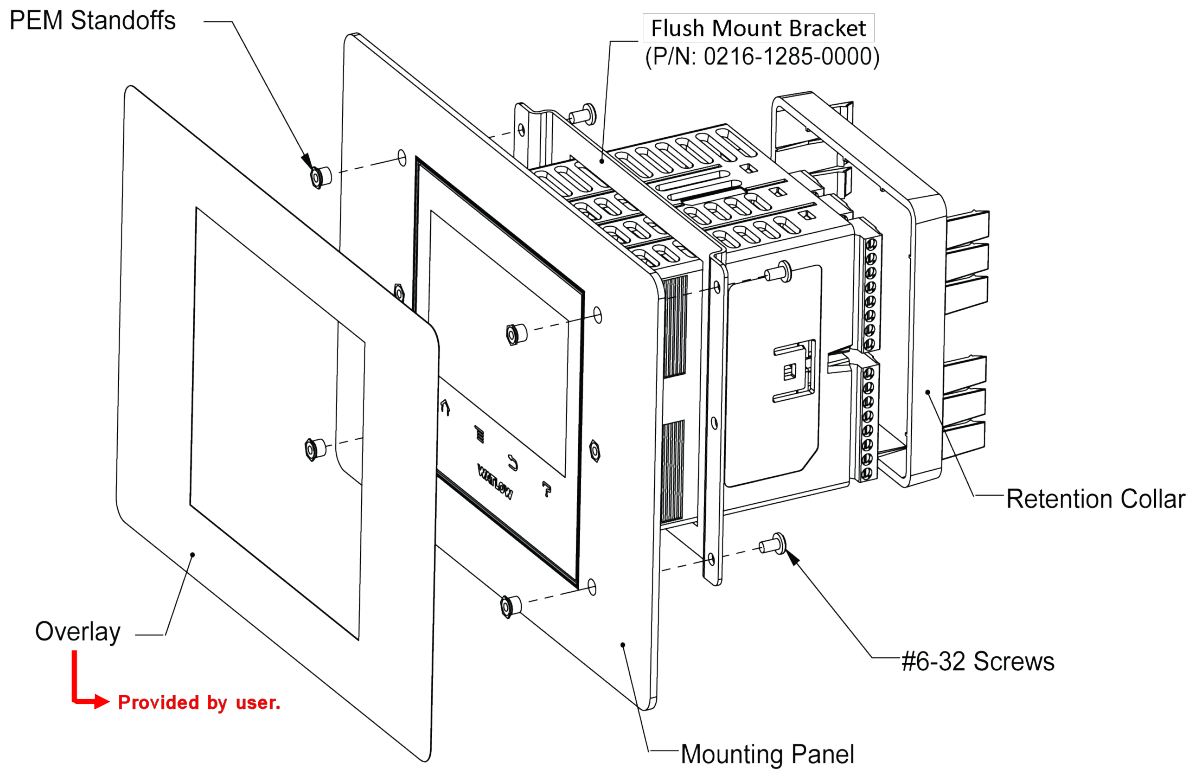

Electrical Isolation

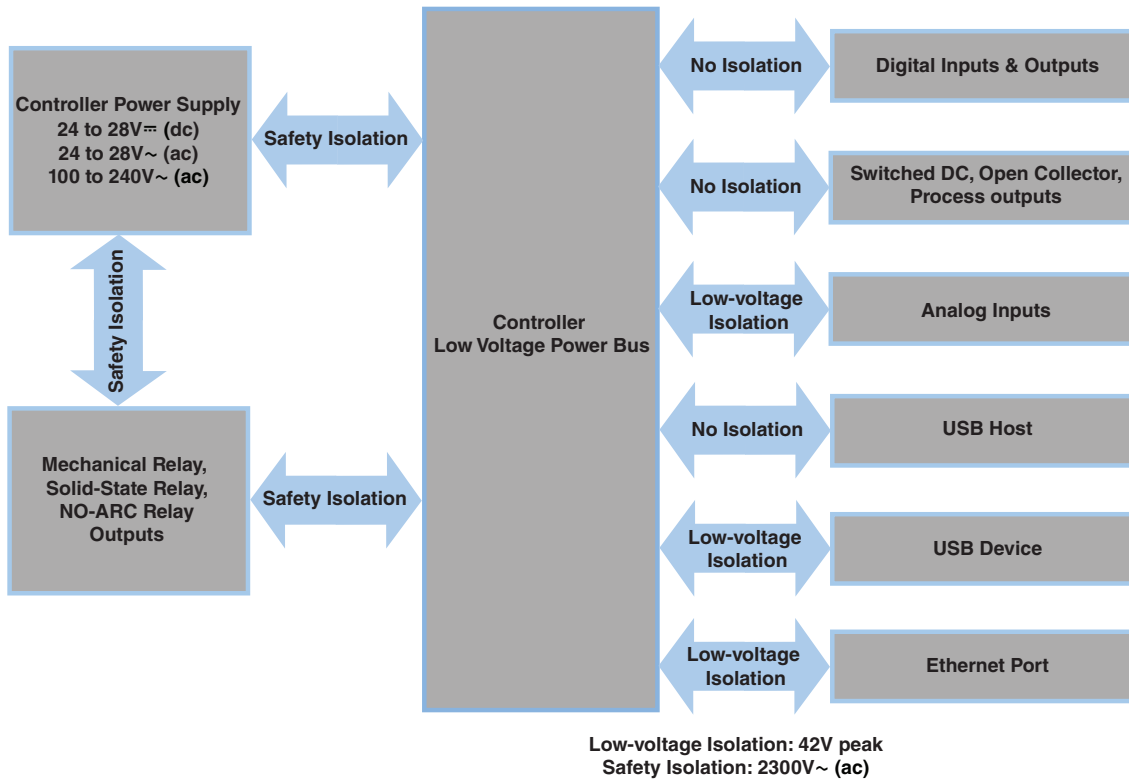

Wiring the F4T Base

Identify Connector Pinout

Power and Communications	
Terminal	Function
98	Power input: ac or dc+
99	Power input: ac or dc-
- - - -	- - - -
CX	Inter-module Bus A
CY	Inter-module Bus B
CZ	Inter-module Bus Common
- - - -	- - - -
GND	Functional earth ground

Warning: ⚡ ⚠

Use National Electric (NEC) or other country-specific standard wiring and safety practices when wiring and connecting this controller to a power source and to electrical sensors or peripheral devices. Failure to do so may result in damage to equipment and property, and/or injury or loss of life.

Avertissement : ⚡ ⚠

Utilisez les pratiques de câblage et de sécurité de National Electric (NEC) ou les normes spécifiques au pays lors du câblage et de la connexion de ce régulateur à une source d'alimentation et aux capteurs électriques ou aux équipements périphériques. Tout manquement à cette règle pourrait provoquer des dégâts sur l'équipement et le matériel, et/ou des blessures personnelles ou des décès.

Wire Size and Torque for Screw Terminations

- 0.0507 to 3.30 mm² (30 to 12 AWG) single-wire termination or two 1.31 mm² (16 AWG)
- 0.57 Nm (5.0 lb.-in.) torque

Power Requirements

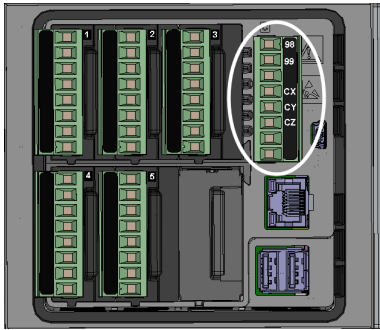

- 85 to 264V~ (ac), (Models F4T __ [1, 2, 3, 4])
- 20.4 to 30.8V~ (ac) or ≡ (dc), (Models F4T __ [5, 6, 7, 8])
- 50 to 60 Hz
- Power consumption 23W, 54VA
- Inter-module Bus (CX, CY, CZ)
- Do not route network wires with power wires. Connect inter-module bus wires in daisy-chain fashion when connecting multiple devices in a network
- The power supply within the controller base meets all power requirements for any and all inserted modules.

Flex Module (FM) Characteristics

Many of the modules appear to look alike at first glance, therefore, it is always recommended that the module part number be noted and verified prior to plugging it into any of the available slots in a base. Each module is identified with a part number located on the back side of the assembly right below the connector (black label), as seen in the graphic to the right.

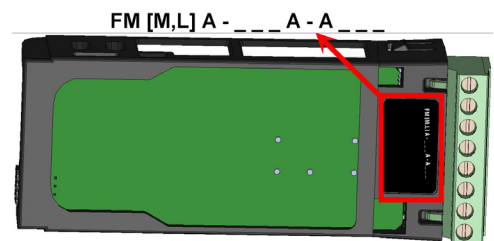

Flex Module Installation - To view video go to www.watlow.com/F4T

Some Flex Modules require that they be installed in specific slots within the base. As an example, if a communications card is to be installed, it must be placed in slot 6. Slot 6 can receive and accept any card, however, it is the only slot that allows for a communication card (see table to the right).

Slots are keyed such that modules cannot be inserted upside down. Insert modules with the component side facing the right when viewing the controller from the rear.

Installing the modules:

1. Note the part number to determine the types of inputs and outputs available to be connected in step 7.
2. Turn off power to the controller.
3. Select a slot for the module (see table to right). If replacing a module, remove the old module.
4. Affix corresponding slot number labels (provided) to the module and to the removable screw terminal block.

Flex Module - Slot Dependencies						
Module Type	Slot #					
	1	2	3	4	5	6
Dual SSR * FMHA-K	Y	Y	N	Y	Y	N
Communications FMCA-(2)	N	N	N	N	N	Y
All Other Modules	Y	Y	Y	Y	Y	Y

Y = Allowed N = Not allowed
* Requires two adjacent slots

5. With the component side of the module facing right (viewing the controller from the rear) insert the module in to the slot until it latches.
6. Remove the screw terminal block from the module.
7. Wire field devices to the appropriate terminals (see. Wiring details for each input and output are provided in the following sections).
8. Reconnect the wired screw terminal block to the module. Be sure to reconnect the terminal block to the correct module.
9. Restore power to the controller.

Note:

If a module is swapped out and replaced with a different type or moved to another open slot after configuration, the controller will no longer function properly without being re-configured using Composer™ software.

Note:

To minimize the possibility of unwanted downtime due to a module being removed and installed into the wrong slot, affix the slot number labels (as directed in step 4 above) to each module (as shown in the graphic below, white circle) and each removable screw terminal block.

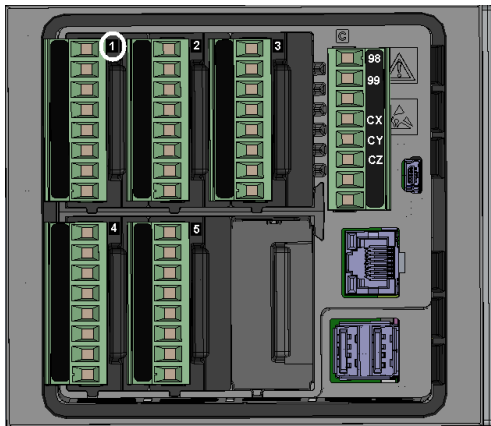

Wiring the Modules

Prior to wiring any of the I/O modules described in this document it is recommended that the warnings and notes listed below be reviewed.

CAUTION: ⚠

To prevent damage to the controller, do not connect wires to unused terminals.

AVERTISSEMENT: Pour prévenir tout endommagement du régulateur, ne pas faire de raccordements à des bornes inutilisées.

CAUTION ⚠ **Quencharc Note:**

Switching pilot duty inductive loads (relay coils, solenoids, etc.) with the mechanical relay, solid-state relay or open collector output options requires the use of an R.C. suppressor for AC load or a diode for a DC load.

AVERTISSEMENT: les charges inductives de commutation de lampes témoins (bobines de relais, solénoïdes, etc.) avec des options de sortie à relais mécanique, de relais statique ou collecteur ouvert requièrent un dispositif antiparasite R.C.

Place the Quencharc directly across the external coil as shown below. For a DC load, place the cathode of the diode, to the positive voltage of the load and the anode to the ground of the load.

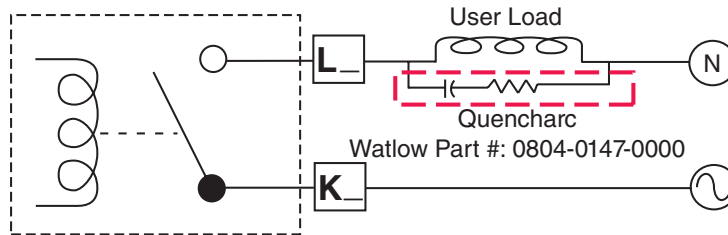

Note:

It is possible that the terminal strip labeling for any given module could be the same. For example, if a Thermocouple input module is installed in slot 1 and 2, each slot would have S1 and R1 on its label. When referencing either of these inputs the differentiating factor is the module slot number, therefore the reference should be input 1 of slot number x.

Note:

Maintain electrical isolation between the analog input, digital input-outputs, switched dc/ open collector outputs and process outputs to prevent ground loops.

Note:

The F4T meets IP10 requirements when the empty slots have slot caps installed.

Note:

Maximum wire size and torque for screw terminations:

- 0.0507 to 3.30 mm² (30 to 12 AWG) single-wire termination or two 1.31 mm² (16 AWG)
- 0.57 Nm (5.0 lb.-in.) torque

Input Connections

Thermocouple FM [M, L] A - [L, U, Y] __ A - A __ __

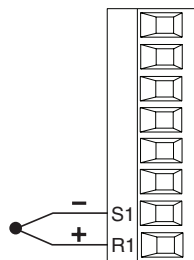

- Grounded or ungrounded sensors, greater than 20MΩ input impedance, 2kΩ source resistance max.
- 3 microampere open-sensor detection
- Thermocouples are polarity sensitive. The negative lead (usually red) must be connected to S terminal
- To reduce errors, the extension wire for thermocouples must be of the same alloy as the thermocouple.

Thermocouple (High Density) FMHA - RAAA - A __ __

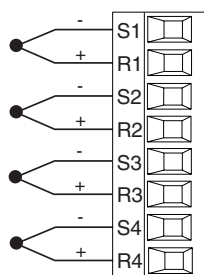

- Grounded or ungrounded sensors, greater than 20MΩ input impedance, 2kΩ source resistance max
- 3 microampere open-sensor detection
- Thermocouples are polarity sensitive. The negative lead (usually red) must be connected to S terminal
- To reduce errors, the extension wire for thermocouples must be of the same alloy as the thermocouple

RTD

FM [M, L] A - [L, U, Y*] __ A - A __ __

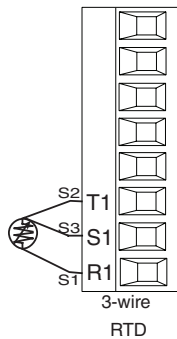
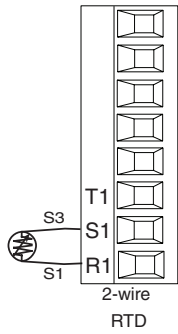

- 2 or 3-wire platinum, 100 and 1,000 Ω @ 32 °F (0 °C) calibration to DIN curve (0.00385 $\Omega/\Omega/^{\circ}\text{C}$)
- RTD excitation current of 0.09 mA typical. Each ohm of lead resistance may affect the reading by 2.55 °C for a 100 ohm platinum sensor or 0.25 °C for a 1000 ohm sensor.
- For 3-wire RTDs, the S1 lead (usually white) must be connected to R1.
- * This option does not support 3-wire RTDs

Lead Wire Resistance	
Each wire for 2-Wire RTDs, not to exceed 10 ohms maximum.	
AWG	Ohms/1000ft
14	2.575
16	4.094
18	6.510
20	10.35
22	16.46
24	26.17
26	41.62
28	66.17

Note:

3-wire RTD's self-compensate for lead wire resistance up to 10 Ω of wire resistance.

RTD (High Density)

FMHA - RAAA - A __ __

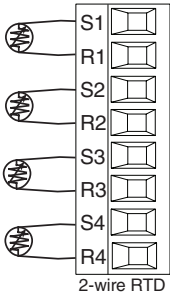

- Platinum, 100 and 1,000 Ω @ 32 °F (0 °C) calibration to DIN curve (0.00385 $\Omega/\Omega/^{\circ}\text{C}$)
- RTD excitation current of 0.09 mA typical. Each ohm of lead resistance may affect the reading by 2.55 °C for a 100 ohm platinum sensor or 0.25 °C for a 1000 ohm sensor (see table to right)

Lead Wire Resistance	
Each wire for 2-Wire RTDs, not to exceed 10 ohms maximum.	
AWG	Ohms/1000ft
14	2.575
16	4.094
18	6.510
20	10.35
22	16.46
24	26.17
26	41.62
28	66.17

Process

FM [M, L] A - [L, U] __ A - A __ __

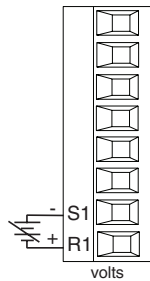
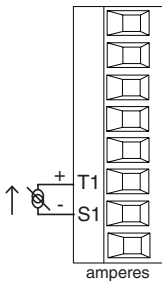

- 0 to 20 mA @ 100 Ω input impedance
- 0 to 10V_{DC} @ 20 k Ω input impedance
- 0 to 50 mV_{DC} @ 20 M Ω input impedance
- Scalable

Input Connections (cont.)

Process (High Density)

FMHA - RAAA - A _ _ _

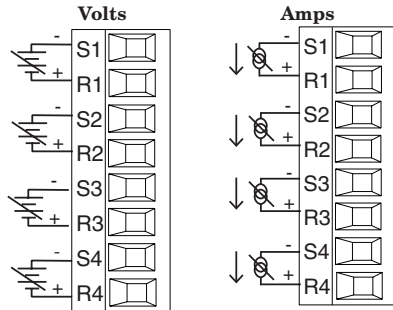

- 0 to 20 mA @ 100 Ω input impedance
- 0 to 10V \rightleftharpoons (dc) @ 20 k Ω input impedance
- 0 to 50 mV \rightleftharpoons (dc) @ 20 M Ω input impedance
- Scalable

Potentiometer FM [M, L] A - [L, U] _ _ A - A _ _ _

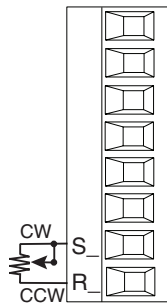

- Potentiometer: 0 to 1,200 Ω

Potentiometer (High Density) FMHA - RAAA - A _ _ _

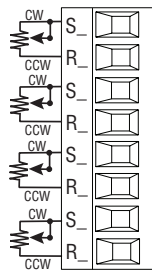

- Potentiometer: 0 to 1,200 Ω

Input Connections (cont.)

Thermistor FM [M, L] A - [M, T] AAA - A _ _ _

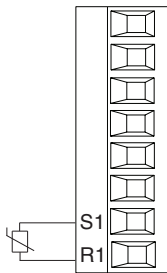

- >20 MΩ input impedance
- 0 to 40kΩ, 0 to 20kΩ, 0 to 10kΩ, 0 to 5kΩ
- 2.252kΩ and 10kΩ base at 77° F (25° C)
- Drive current is 109 μA as a constant current source
- User-selectable curves for Alpha Technics, BetaTHERM and YSI
- User-scaling support for Steinhart-Hart coefficients

Thermistor Curve Setting	Base R @ 25 °C	Alpha Technics	Beta Therm	YSI
Curve A	2.252K	Curve A	2.2K3A	004
Curve B	10K	Curve A	10K3A	016
Curve C	10K	Curve C	10K4A	006
Custom	Use Steinhart-Hart equation coefficients (A, B and C) from thermistor manufacturer corresponding to the terms of the Steinhart-Hart equation: $1 / T = A + B \ln(R) + C (\ln(R))^3$			

Thermistor (High Density) FMHA - PAAA - A _ _ _

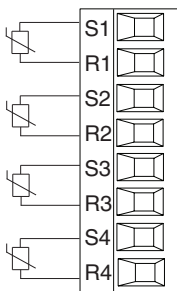

- >20 MΩ input impedance
- 0 to 40kΩ, 0 to 20kΩ, 0 to 10kΩ, 0 to 5kΩ
- 2.252kΩ and 10kΩ base at 77° F (25° C)
- Drive current is 109 μA as a constant current source
- User-selectable curves for Alpha Technics, BetaTHERM and YSI
- User-scaling support for Steinhart-Hart coefficients

Thermistor Curve Setting	Base R @ 25 °C	Alpha Technics	Beta Therm	YSI
Curve A	2.252K	Curve A	2.2K3A	004
Curve B	10K	Curve A	10K3A	016
Curve C	10K	Curve C	10K4A	006
Custom	Use Steinhart-Hart equation coefficients (A, B and C) from thermistor manufacturer corresponding to the terms of the Steinhart-Hart equation: $1 / T = A + B \ln(R) + C (\ln(R))^3$			

Input Connections (cont.)

Digital Input FMLA - YEBA - A _ _ _ _

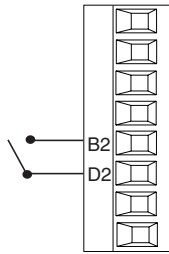

- Update rate 10Hz
- Voltage
 - Max. input 36V at 3mA
 - Input inactive when $\leq 2V$
 - Input active when $\geq 3V$ at 0.25mA
- Dry contact
 - Input inactive when $\geq 500\Omega$
 - Input active when $\leq 100\Omega$
 - Max. short circuit 13mA

Voltage Input

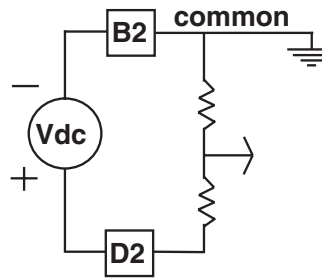

Dry Contact

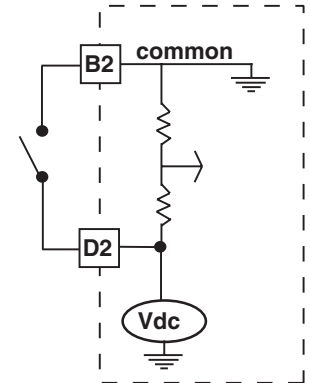

Digital Input (High Density) FMHA - CAAA - A _ _ _ _

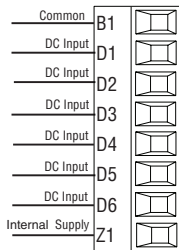

- Voltage
 - Max. input 36V at 3mA
 - Input inactive when $\leq 2V$
 - Input active when $\geq 3V$ at 0.25mA
- Dry contact
 - Input inactive when $\geq 500\Omega$
 - Input active when $\leq 100\Omega$
 - Max. short circuit 13mA

Voltage Input

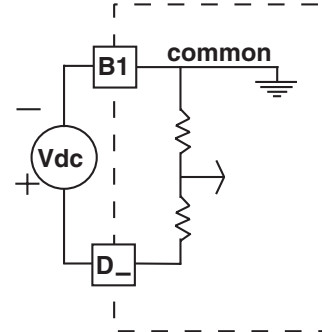

Dry Contact

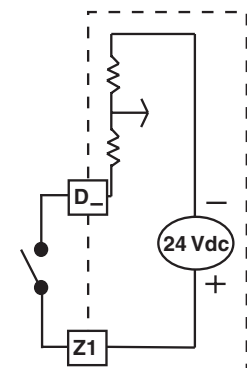

Current Transformer FMMA - C _ _ A - A _ _ _

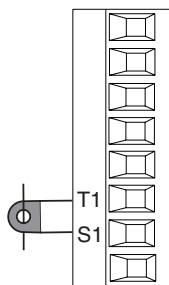

- Input range is 0 to 50 mA (ac).
- Current transformer part number: 16-0246
- 100 Ω input impedance
- Response time: 1 second maximum
- Accuracy +/- 1 mA typical

Example: Using a Current Transformer

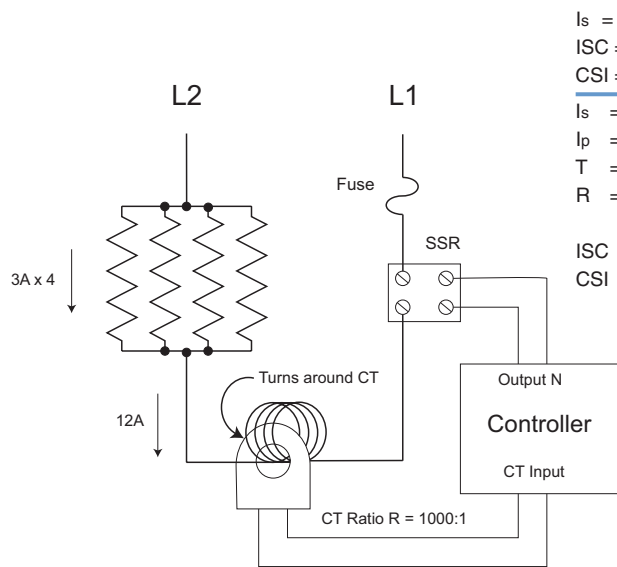

$$I_s = I_p T / R = 50\text{mA}$$

$$ISC = I_p(\text{full scale}) = 50\text{mA}(R)/T$$

$$CSI = \text{Output N}$$

I_s = Current in secondary of current transformer

I_p = Current in primary of current transformer

T = Number of turns through the primary of the transformer

R = Number of turns in the secondary of the current transformer (Turns ratio, assuming one primary turn)

ISC = Input Scaling (parameter found in Current function block)

CSI = Current Output Source Instance (parameter found in Current function block)

$$12\text{A} \times 4 = 48\text{A} \quad : \quad 48\text{mA}$$

48mA

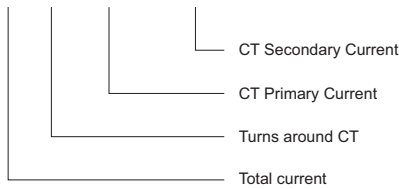

Output Connections

Mechanical Relay Form A

FM [M, L]A - __ JA - A __ __

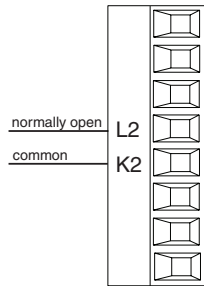

- 5 A at 240V~ (ac) or 30V= (dc) maximum resistive load
- 20 mA at 24V minimum inductive load
- 125 VA pilot duty at 120/240V ~ (ac), 25 VA at 24V ~ (ac)
- 100,000 cycles at rated load
- Output does not supply power
- For use with ac or dc
- See [Quencharc](#) note (page 12)

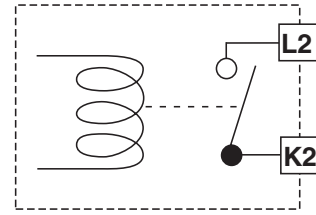

NO-ARC Relay Form A

FMMA - __ HA - A __ __

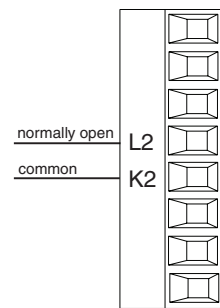

- 12A at 122° F (50° C), 85 to 264V~ (ac) resistive load only (see derating curve)
- 2,000,000 cycle rating for rated load
- 100 mA minimum load
- 2 mA maximum off state leakage
- Do not use on dc loads
- Output does not supply power
- Do not drive another relay or solenoid with this output type
- See [Quencharc](#) note (page 12)

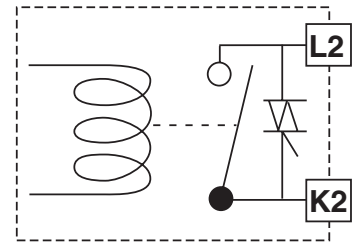

Solid-State Relay Form A

FMMA - _ KKA - A __ __

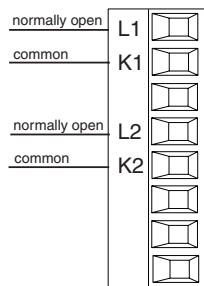

- 0.5A at 149° F (65° C) to 1A at 50° F (10° C), 24 to 264V~ (ac) maximum resistive load
- 20 VA 120/240V~ (ac) pilot duty
- Opto-isolated, without contact suppression
- Maximum off state leakage of 105 microamperes
- Output does not supply power
- Do not use on dc loads
- See [Quencharc](#) note (page 12)

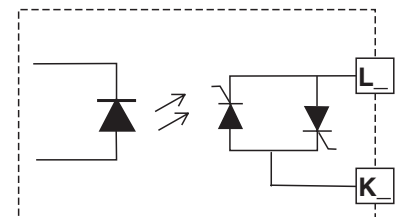

Output Connections (cont.)

Four Mechanical Relays Form A (High Density) FMHA - JAAA - A _ _ _ _

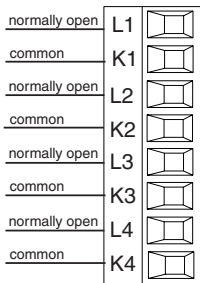

- 5 A at 240V~ (ac) or 30V= (dc) maximum resistive load
- 20 mA at 24V minimum load
- 125 VA pilot duty @ 120/240V~ (ac), 25 VA at 24V~ (ac)
- 100,000 cycles at rated load
- Output does not supply power.
- For use with ac or dc
- See [Quencharc](#) note (page 12)

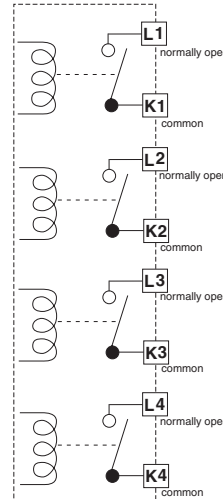

Dual Solid-State Relays, Form A (High Density) FMHA - KAAA - A _ _ _ _

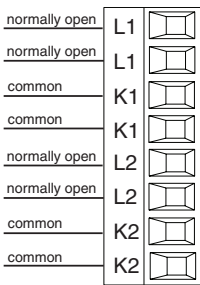

- 10 A at 20 to 264V~ (ac) maximum resistive load
- 10A per output at 240V~ (ac), max. 20A per card at 122° F (50° C)
- Opto-isolated, without contact suppression
- Maximum off state leakage of 105 microamperes
- Output does not supply power
- Do not use on dc loads.

Note:

This module requires 2 slots, therefore it cannot be placed in slot 3 or 6.

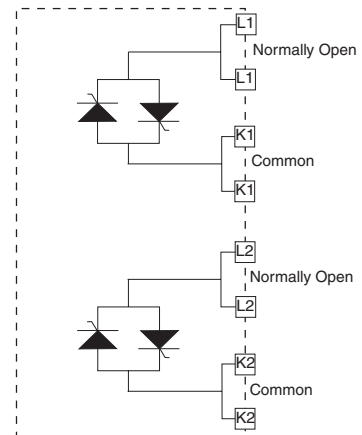

Output Connections (cont.)

Four 2A Solid-State Relays, Form A (High Density)

FMHA - LAAA - A _ _ _

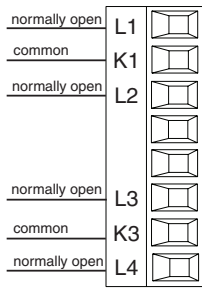

- 2A at 20 to 264V~ (ac) maximum resistive load
- 50 VA 120/240V~ (ac) pilot duty
- Optical isolation, without contact suppression
- Maximum off state leakage of 105 μ A
- Output does not supply power.
- Do not use on dc loads.
- N.O., COM, N.O wiring (shared common) between each set of outputs.
- See table below for maximum current output.

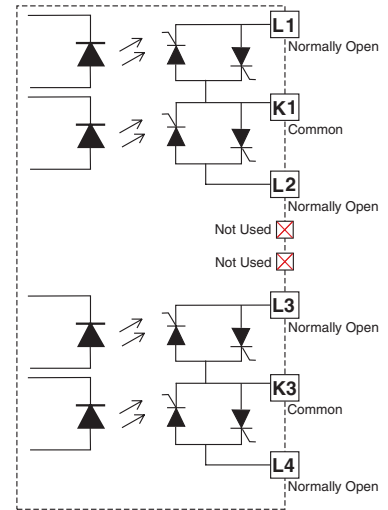

Quad 2 Amp SSR Derating Curve
All Outputs 100% Duty Cycle

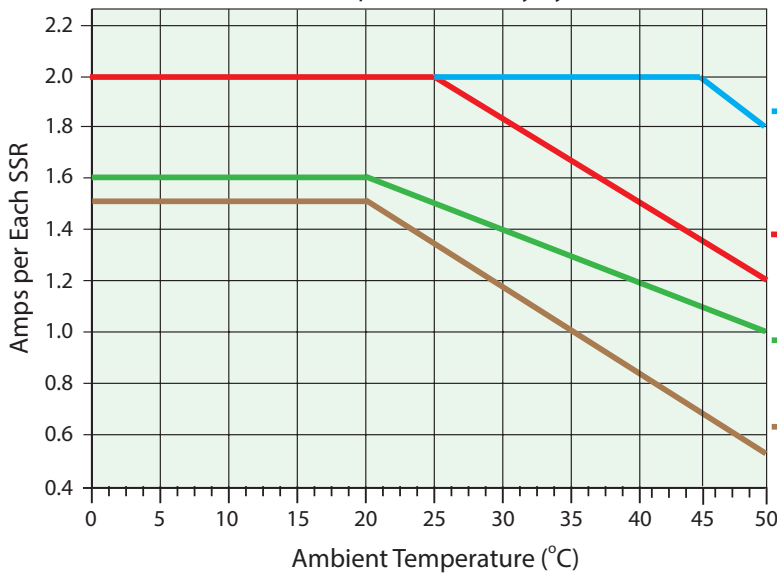

F4T with 2 FM's: 1 quad input and 1 quad 2A SSR FM. Outputs 1 and 3 on.

F4T with 2 FM's: 1 quad input and 1 quad 2A SSR FM. All outputs on.

F4T with 5 FM's: 1 quad 2A SSR.

F4T with 6 FM's: 1 quad 2A SSR.

Output Connections (cont.)

3 Mechanical Relays, 2 Form C, 1 Form A (High Density) FMHA - BAAA - A _ _ _ _

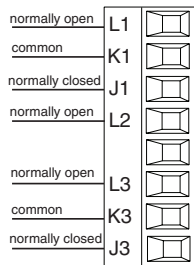

- 5A at 24 to 240V~ (ac) or 30V \equiv (dc) maximum resistive load
- 125VA pilot duty 120/240V~ (ac) 25 VA at 24V~ (ac)
- Output does not supply power
- Form A relay shares common with one Form C relay.
- See [Quencharc](#) note (page 12)

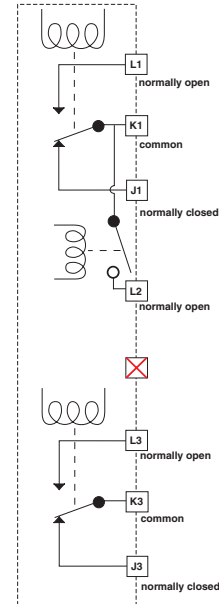

Mechanical Relay Form C

FM [M, L]A - _ E _ A - A _ _ _ _

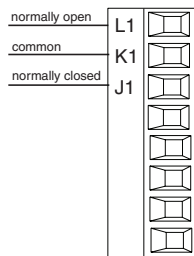

- 5 A at 240V~ (ac) or 30V \equiv (dc) maximum resistive load
- Requires a minimum load of 20 mA at 24V
- 125 VA pilot duty at 120/240V~ (ac), 25 VA at 24V~ (ac)
- 100,000 cycles at rated load
- Output does not supply power.
- For use with ac or dc
- See [Quencharc](#) note (page 12)

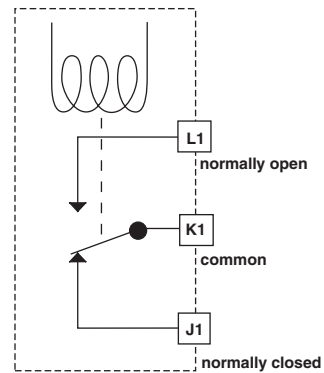

Universal Process

FMMA - _ F _ A - A _ _ _ _

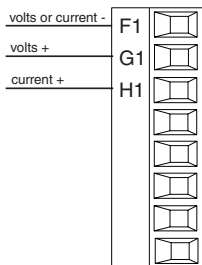

- 0 to 20 mA \pm 30 μ A into 800 Ω maximum load with 5 μ A nominal resolution
- 0 to 10V \equiv (dc) \pm 15mV into 1 k Ω minimum load with 2.5mV nominal resolution
- Scalable
- Output supplies power
- Cannot use voltage and current outputs at same time
- Output may be used as retransmit or control
- Temperature stability 100 ppm/ $^{\circ}$ C

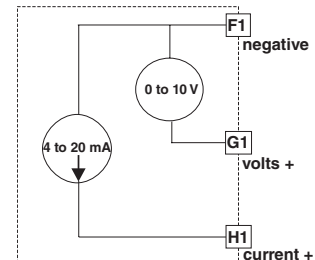

Output Connections (cont.)

Tri-Process/Retransmit (High Density)

FMHA - FAAA - A _ _ _

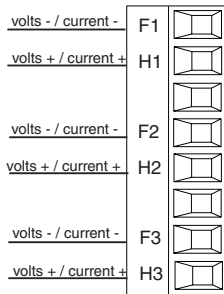

- 0 to 20 mA into 400Ω maximum load
- 0 to 10V $\overline{\text{dc}}$ (dc) into 4 kΩ minimum load
- Outputs are scalable
- Output supplies power
- Each output can be independently set for voltage or current
- Output may be used as retransmit or control

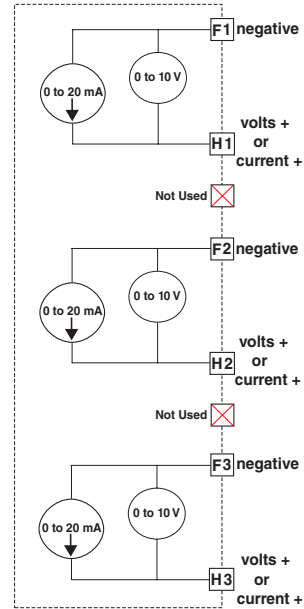

Switched DC / Open Collector FM [M, L] A - _ CCA - A _ _ _

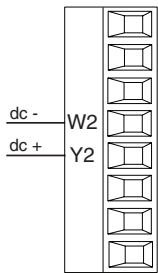

Switched DC

- Output 1 and 2, 30 mA dc maximum supply current not to exceed 40 mA combined when both outputs are used
- Short circuit limited to <50 mA
- 22 to 32V $\overline{\text{dc}}$ (dc) open circuit voltage

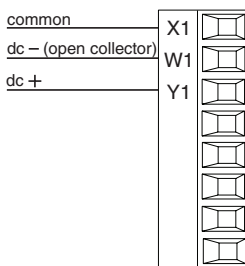

- Use dc- and dc+ to drive external solid-state relay.
- DIN-A-MITE compatible

Open Collector (Output 1 only)

- 100 mA maximum output current sink
- 30V $\overline{\text{dc}}$ (dc) maximum supply voltage
- Any switched dc output can use the common terminal.
- Use an external class 2 or *SELV power supply to control a dc load, with the load positive to the positive of the power supply, the load negative to the open collector and common to the power supply negative.
- *Safety Extra Low Voltage

Switched DC FM [M, L] A - _ [C] [C] A - A _ _ _

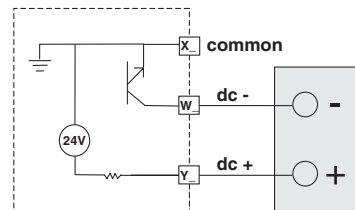

Note:

Total current of 40 mA not to be exceeded if both outputs are used.

Open Collector FM [M, L] A - _ [C] _ A - A _ _ _

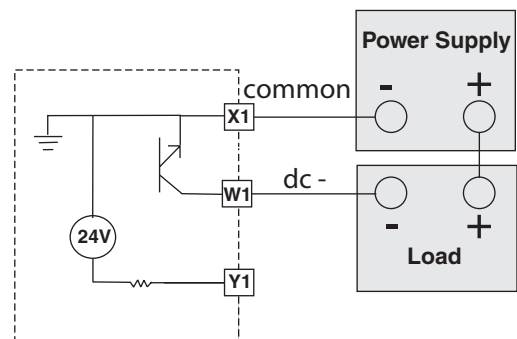

Output Connections (cont.)

Six Digital Outputs (High Density)

FMHA - CAAA - A _ _ _ _

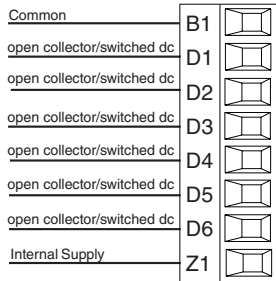

Open Collector

- Maximum switched voltage is 32V_{DC} (dc)
- 400mA, maximum open circuit voltage of 25V_{DC} (dc), typical 8V_{DC} (dc) at 80mA
- Maximum output sink current per output is 1.5A (external class 2 or *SELV supply required)
- Total sink current for all outputs not to exceed 8A
- Do not connect outputs in parallel
- *Safety Extra Low Voltage

Switched DC

- User selectable voltage, 5V_{DC} (dc) at 130mA or 19 to 22V_{DC} (dc) at 80mA

Open Collector Outputs

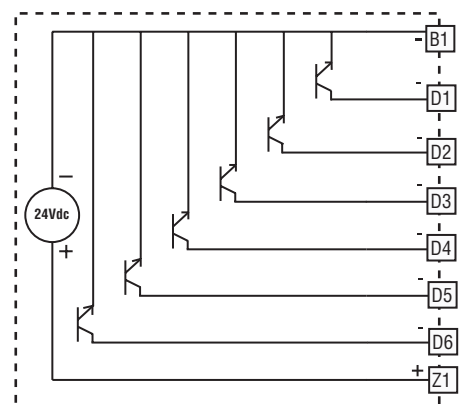

Switched DC Outputs

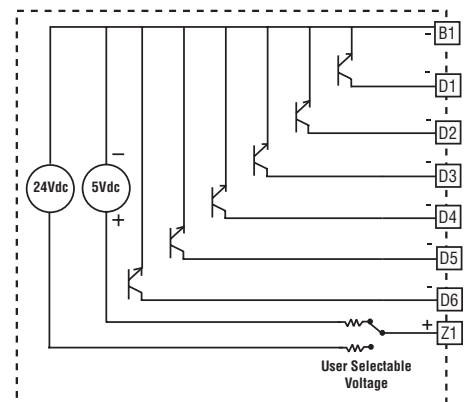

Digital Output - Switched DC Wiring Example

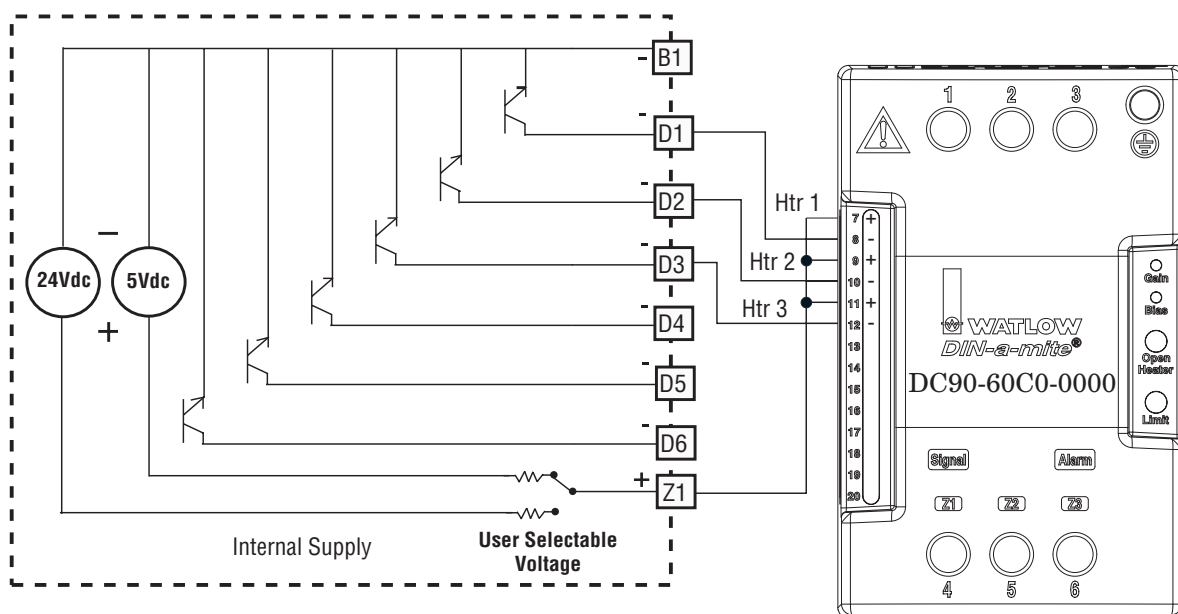

Note:

As a switched DC output; this output is a constant current output delivering 750 mW, current limited to 150 mA. The internal supply is 5V(dc) open circuit. Pin Z1 is shared to all digital outputs. This type of output is meant to drive solid state relays, not mechanical

Output Connections (cont.)

relays. As an open collector output, use an external power supply with the negative wired to B1, the positive to the coil of a pilot mechanical relay and the other side of the coil wired to D_. Each open collector output can sink 1.5 A with the total for all open collector outputs not exceeding 8 amperes. Ensure that a kickback diode is reverse wired across the relay coil to prevent damage to the internal transistor.

Digital Output - Open Collector Wiring Example

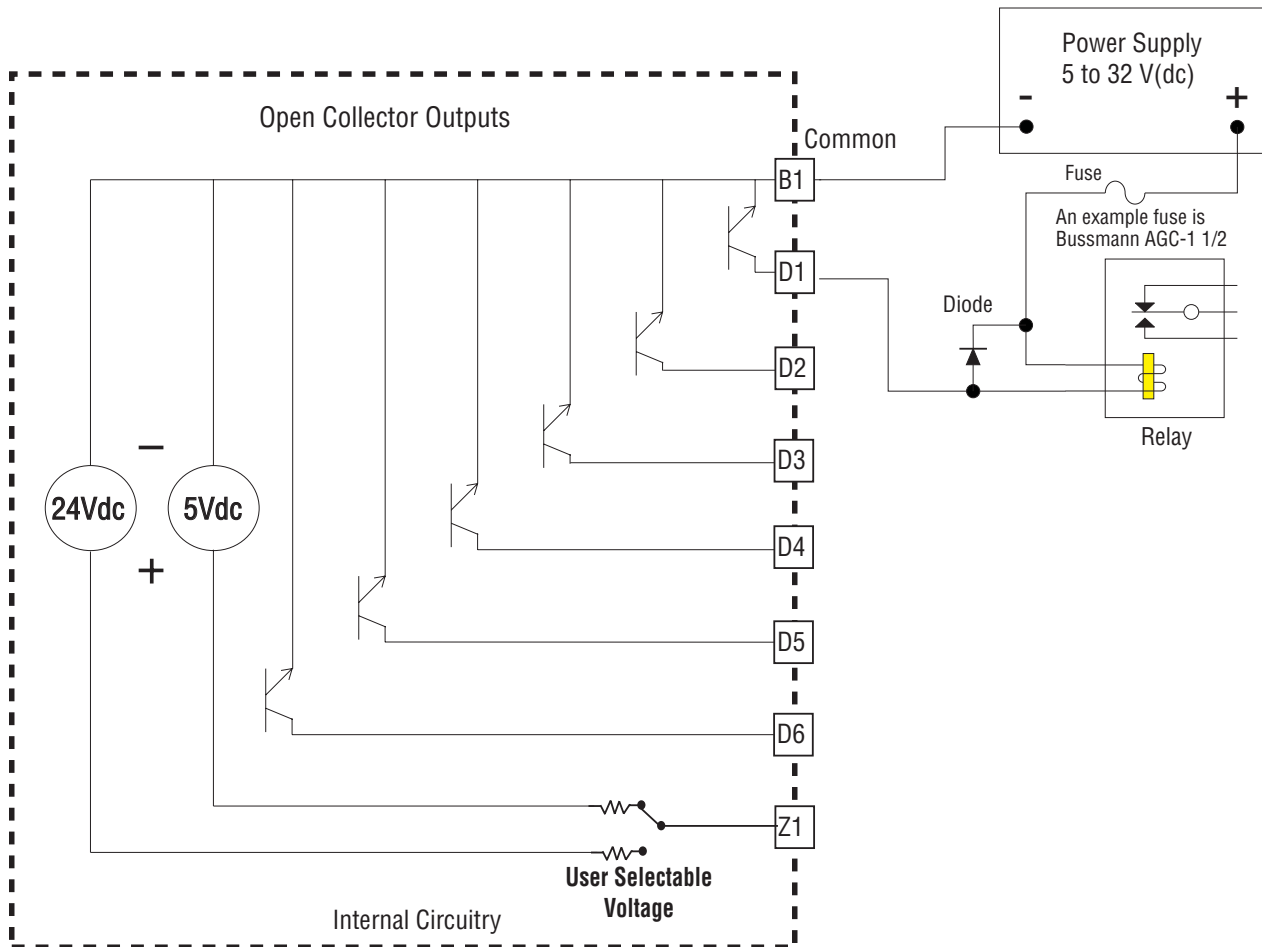

Communications Connections

EIA-232/485 Modbus RTU Communications

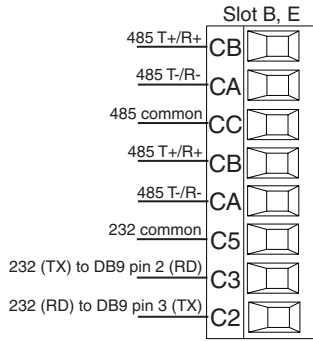

- Wire T-/R- to the A terminal of the EIA-485 port.
- Wire T+/R+ to the B terminal of the EIA-485 port.
- Wire common to the common terminal of the EIA-485 port.
- Do not route network wires with power wires. Connect network wires in daisy-chain fashion when connecting multiple devices in a network.
- A termination resistor may be required. Place a 120 Ω resistor across T+/R+ and T-/R- of last controller on network.
- Do not wire to both the EIA-485 and the EIA-232 pins at the same time.
- Two EIA-485 terminals of T/R are provided to assist in daisy-chain wiring.
- Do not connect more than one controller on an EIA-232 network.
- Do not connect more than 16 controllers on a Standard Bus EIA-485 network.
- Maximum number of controllers on a Modbus network is 247.
- Maximum EIA-232 network length: 15 meters (50 feet)
- Maximum EIA-485 network length: 1,200 meters (4,000 feet)
- 1/8th unit load on EIA-485 bus.

Modbus-IDA Terminal	EIA/TIA-485 Name	Watlow Terminal Label	Function
D0	A	CA or CD	T-/R-
D1	B	CB or CE	T+/R+
common	common	CC or CF	common

Note:

This module must be placed in slot 6.

3

Chapter 3: Connecting a PC

Using the User Interface (UI) to Change or View Ethernet Settings

Understanding the Front Panel Navigational Buttons

When looking at the front panel of the F4T, at the bottom of the display, four push buttons are displayed as icons shown below. The text in this graphic was placed there for clarity only and is not present on the front panel.



- *Home*: regardless of the screen currently in view, when pushed, will always return to the Home screen which displays the following after personalization:
 - Loop name, user designated (Chamber Temp, as shown above).
 - Control mode (Auto, as shown above).
 - Process Value, input connected to the PV receiver of the loop function block.
 - Set Point, which represents the desired value to be maintained by the controller.
 - PWR, output power levels for heat and cool if both are configured.
 - Output Actions, allows a user to monitor the on/off status of user defined inputs or outputs.
- *Menu*: as shown below, will provide access to other settings and functions within the controller.

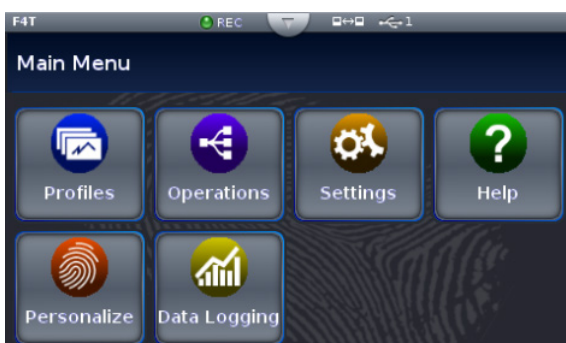

- *Return*: when pushed, this button will take the user back to the previous screen until the top level of either the home screen or the main menu are reached.
- *Help*: displays information **about** the controller such as: part number, software revision etc...

Note:

Menu buttons can change depending on options ordered (Data Logging) and function blocks used (Alarm).

Default Ethernet Parameters and Settings

The bracketed bold settings below represent the defaults as delivered from the factory:

- IP Address Mode: [**DHCP**], Fixed
 - DHCP, Dynamic Host Configuration Protocol, allows for dynamic distribution of network settings by a DHCP server.
 - Fixed, also referred to as a static IP address, is configured manually for a specified network.
- Actual IP Address: [**192.168.0.222**]
- Actual IP Subnet: [**255.255.255.0**]
 - Subnet, a method used to logically divide and isolate networks.
- Actual IP Gateway: [**0.0.0.0**]
 - Gateway, is a device used on the network to route messages with IP addresses that do not exist on the local network.
- MAC Address: xx:xx:xx:xx:xx:xx (Will be different and unique for each controller)
 - MAC address, is a manufacturer supplied address for the network interface card.
- Display Units: [**°F**] (Fahrenheit), °C (Celsius)
- Modbus® TCP Enable: [**Yes**], No
 - Modbus is an industrially hardened field bus protocol used for communications from the controller to other devices on the network.
- Modbus Word Order: [**High**], Low
 - Modbus allows a user to select the word order of two 16-bit words in floating point values.
- Data Map: [**1**], 2
 - Data Map, the user can switch Modbus registers from the comprehensive listing of F4T registers to a limited set of the legacy F4 controller registers (1 = F4T, 2 = F4 compatibility).

To change Ethernet parameters:

1. Push the **Menu**, **Settings** and **Network** buttons, in that order.
2. Under "Communications Channels" push **Ethernet**.
3. Change desired settings.
4. Cycle power to the F4T (changes to IP address will take effect until this step is performed)

Connecting the F4T Base to a PC

DHCP Connection

There are two ways to connect the F4T over Ethernet to a PC (Fixed IP or DHCP). Because the F4T is delivered as a DHCP client, we'll take a look at this method first. The picture below shows two F4T controllers connected through a switch to a DHCP server. When the F4Ts are powered up on the network the DHCP server will assign IP addresses to them. Using this method allows the F4Ts to come up in the same network as the PC with minimal changes to the default F4T Ethernet configuration.

To connect using DHCP:

1. Connect Ethernet cables from F4T RJ45 connector to the Ethernet switch.
2. Cycle power on the F4T controllers.
3. DHCP server will detect them on the network and give them IP addresses automatically.

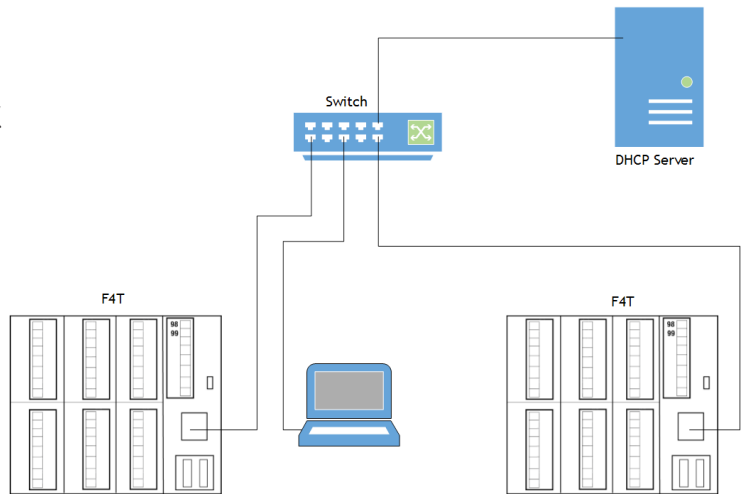

Fixed IP Connection

If it is desired to connect the F4T directly to a PC as shown in the graphic below follow the steps below to do so. It should be noted too that there are alternatives to the steps defined below, this is one way to do this.

To connect using Fixed IP changing PC IP address:

1. Connect Ethernet cables from F4T RJ45 connector to PC Ethernet port.
2. On the PC navigate to the control panel and click on **Network and Sharing Center**
3. Click on **Change adapter settings**
4. Double-click on the **Local Area Connection** (the Ethernet port where cable is connected icon).
5. Click the **Properties** button.
6. Double-click on **Internet Protocol Version 4 (TCP/IPv4)** button.
7. Click the radio button identified as **Use the following IP address**.
8. Change the IP address so that the first 3 octets match the first 3 octets of the F4T IP address while ensuring that the last octet for both the PC and the F4T are unique and between 0 and 255. If there are other devices on this network all must have a unique address.
9. Change the Subnet mask to match what was entered for the F4T.
10. Click **OK** when done (this change to the IP address will take effect immediately)



To connect using Fixed IP changing F4T IP address:

1. Push the **Menu**, **Settings** and **Network** buttons, in that order.
2. Under "Communications Channels" push **Ethernet**.
3. Change desired settings to match the PC ensuring a unique IP address for each.
4. Cycle power to the F4T (changes to IP address will not take effect until this step is performed).

Composer Software

Composer™ is the PC-based software used to configure an F4T controller for a specific application. Use Composer to configure which flex modules the controller expects to find in each of its slots and to customize the controllers functions for your application. To acquire Composer software free of charge, point your browser to: <http://www.watlow.com/F4T.cfm>. Once there, scroll down to find and download Composer software.

For detailed instructions in installing and using Composer software see chapter 2 of the F4T Setup and Operation User Guide.

Starting Composer™ Software

To start the software:

1. Click the **Start** button and then type composer.exe in the search box to find the executable.
2. Double-click on the file "composer.exe".

Note:

If experiencing difficulties installing or using Composer software, prior to contacting Watlow technical support, be prepared to send the user log file to the tech support team. This text file can be found here:

C:\Users\username\AppData\Roaming\Watlow\EZ-Zone Composer\Logs

The red text above will change to the users Windows login name.

Verifying Pluggable Flex Module Installation Using Composer™

Connect to the desired system:

1. From the systems screen double-click on the online system.



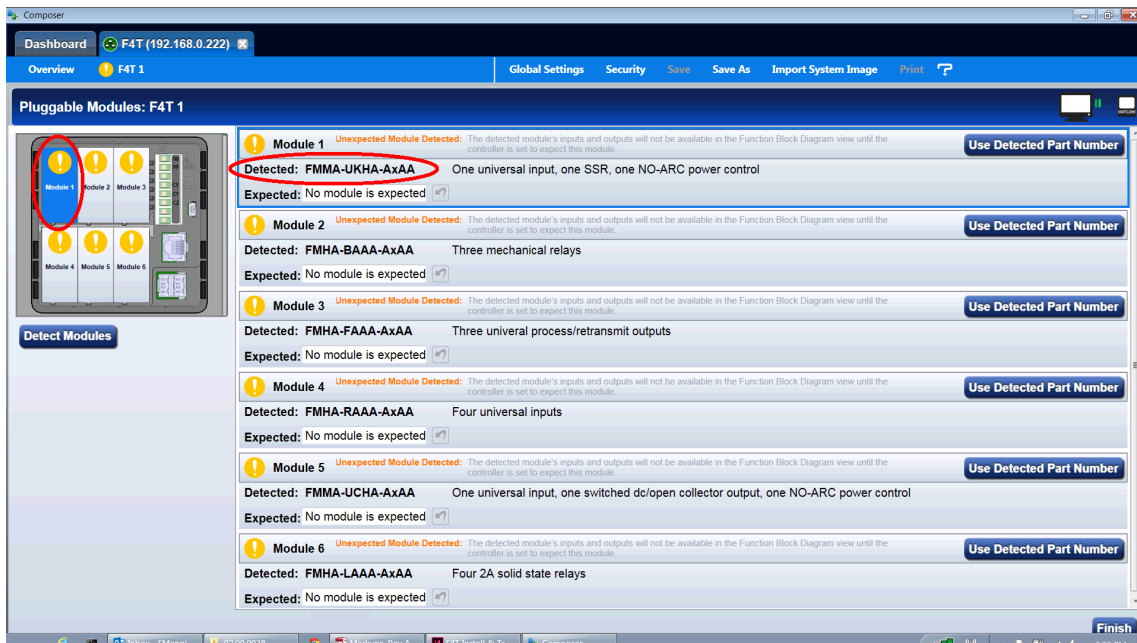

Enter Pluggable Module Screen:

1. Click on the desired **Device** from the menu bar and then **Pluggable Modules**.
2. Verify that the detected module (as shown in the graphic below) for each slot matches what was noted in step 1 ([Installing the modules](#)).



Symbols Related to Pluggable Modules

As viewed from the Menu bar, the symbol that will be displayed to the left of the Pluggable Modules button will be of the most significance. The red exclamation will always take precedence.

Symbol	Description
	The expected module has been detected.
	No module has been detected in a slot the controller expects to be empty.
	A module has been detected in a slot the controller expects to be empty.
	The controller expects a module, but that module is missing or a different module has been detected.

4

Chapter 4: Calibration

Calibrating the F4T Inputs

All controllers are calibrated and are accurate to the specified specifications (see [Appendix](#) for specifications) when they ship from the manufacturing facility.

If an input is suspect as being out of calibration it is recommended that prior to performing any calibration procedure that the user verify that the displayed readings are not within published specifications. Input a known value from a precision source to the analog input and subtract the displayed value with the known value and compare this difference to the published accuracy range specification (see [Appendix](#) for specifications) for that type of input.

Use of the Calibration Offset parameter found when viewing the Universal Input parameters from within Composer™ software or while viewing the input from the front panel Operations menu, shifts the readings across the entire displayed range by the offset value. Use this parameter to compensate for sensor error or sensor placement error. Typically this value is set to zero.

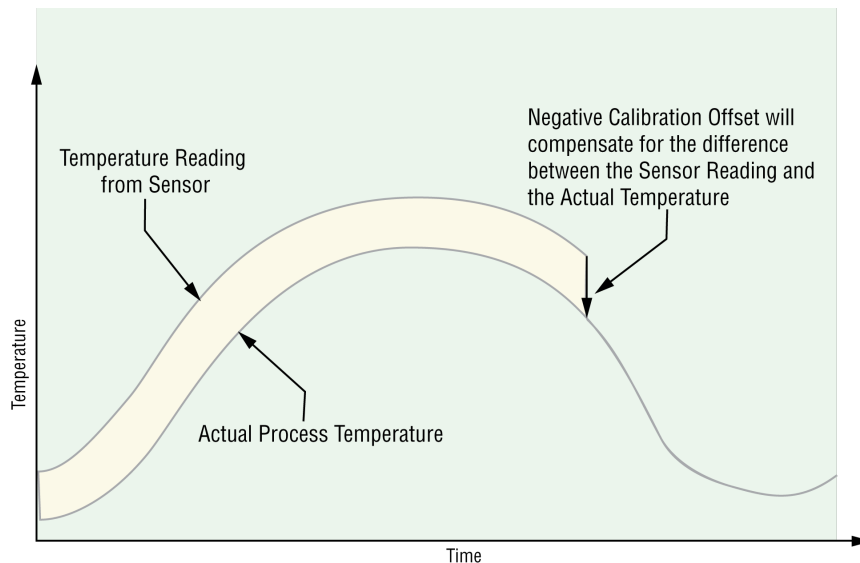

Required Equipment When Performing Calibration

Obtain a precision source for millivolts, volts, milliamperes or resistance depending on the sensor type to be calibrated. Use copper wire only to connect the precision source to the controller's input. Keep leads between the precision source and controller as short as possible to minimize error. In addition, a precision volt/ohm meter capable of reading values to 4 decimal places or better is recommended. Prior to calibration, connect this volt/ohm meter to the precision source to verify accuracy.

Actual input values do NOT have to be exactly the recommended values, but **it is critical** that the actual value of the signal connected to the controller be accurately known to at least four digits.

Calibration of Analog Inputs

To calibrate an analog input, you will need to provide a source of two electrical signals or resistance values near the extremes of the range that the application is likely to utilize. See recommended values below:

Sensor Type	Precision Source Low	Precision Source High
Thermocouple	0.000 mV	50.000 mV
Millivolts	0.000 mV	50.000 mV
Volts	0.000V	10.000V
Milliamps	0.000 mA	20.000 mA
100 Ω RTD	50.00 Ω	350.0 Ω
1,000 Ω RTD	500.0 Ω	3,500 Ω
Thermistor 5 k Ω	50.00	5,000
Thermistor 10 k Ω	150.0	10,000
Thermistor 20 k Ω	1,800	20,000
Thermistor 40 k Ω	1,700	40,000
Potentiometer	0.000	1,200



Control loops, alarms, limits and any other functions that receive signals from the analog input will act on the high and low signals applied in this procedure.

Note:

When calibrating a Universal Input configured as a 3-wire RTD, ensure that the calibrated source is connected across R and both T and S inputs.

Note:

If the user exits this procedure at any point by clicking cancel or simply navigating away to another screen, the previous calibration for the selected input will be restored.

Note:

The calibration values entered using this procedure will be overwritten whenever the controller has the factory settings restored.

Note:

There are three security settings that can be applied to the calibration screens through the *Diagnostics and Troubleshooting* (see the System Overview section of the F4T Setup and Operation User's Guide for more information) access point:

1. Full Access - full capabilities to calibrate available
2. Read Only - first calibration screen displayed
3. No Access - calibration screens not available

Using Composer™ Software to Calibrate Analog Inputs

To obtain access to the calibration screens:

1. Start Composer software if not already running.
2. From the Dashboard click on **Connect to a System** and select the appropriate device.
3. From the System Overview screen click on the **Device** menu button where a drop down list will appear.
4. Click on **Calibrate**.
5. Select the appropriate Module and Input and then click on **Perform Field Calibration**.
6. Follow instructions on the screen.

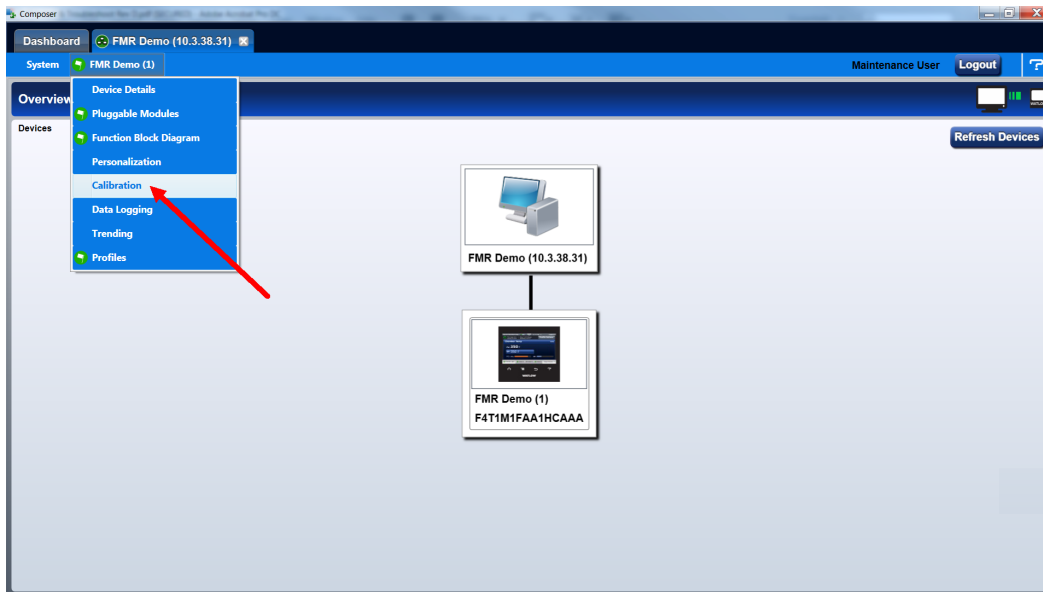

Using the User Interface to Calibrate Analog Inputs

To calibrate from the F4T front panel:

1. Push the **Menu**, **Service** and **Calibration** buttons, in that order.
2. Select the desired module and input and then push **Perform Field Calibration**.
3. Follow instructions on the screen.

Note:

At any point in time (using Composer software or the UI) the selected module and input can be brought back to the factory calibration settings by selecting "Restore Factory Calibration".

5

Chapter 5: Troubleshooting

Indication	Description	Possible Cause(s)	Corrective Action
Alarm won't clear or reset	Alarm will not clear or reset with keypad or digital input	<ul style="list-style-type: none"> • Alarm latching is active • Alarm set to incorrect output • Alarm is set to incorrect source • Sensor input is out of alarm set point range • Alarm set point is incorrect • Alarm is set to incorrect type • Digital input function is incorrect 	<ul style="list-style-type: none"> • Reset alarm when process is within range or disable latching • Set output to correct alarm source instance • Set alarm source to correct input instance • Correct cause of sensor input out of alarm range • Set alarm set point to correct trip point • Set alarm to correct type: process, deviation or power • Set digital input function and source instance
Alarm won't occur	Alarm will not activate output	<ul style="list-style-type: none"> • Alarm silencing is active • Alarm blocking is active • Alarm is set to incorrect output • Alarm is set to incorrect source • Alarm set point is incorrect • Alarm is set to incorrect type 	<ul style="list-style-type: none"> • Disable alarm silencing, if required • Disable alarm blocking, if required • Set output to correct alarm source instance • Set alarm source to correct input instance • Set alarm set point to correct trip point • Set alarm to correct type: process, deviation or power
Alarm Error	Alarm state cannot be determined due to lack of sensor input	<ul style="list-style-type: none"> • Sensor improperly wired or open • Incorrect setting of sensor type • Calibration corrupt 	<ul style="list-style-type: none"> • Correct wiring or replace sensor • Match setting to sensor used • Check calibration of controller

Indication	Description	Possible Cause(s)	Corrective Action
Alarm Low	Sensor input below low alarm set point	<ul style="list-style-type: none"> • Temperature is less than alarm set point • Alarm is set to latching and an alarm occurred in the past • Incorrect alarm set point • Incorrect alarm source 	<ul style="list-style-type: none"> • Check cause of under temperature • Clear latched alarm • Establish correct alarm set point • Set alarm source to proper setting
Alarm High	Sensor input above high alarm set point	<ul style="list-style-type: none"> • Temperature is greater than alarm set point • Alarm is set to latching and an alarm occurred in the past • Incorrect alarm set point • Incorrect alarm source 	<ul style="list-style-type: none"> • Check cause of over temperature • Clear latched alarm • Establish correct alarm set point • Set alarm source to proper setting
Error Input	Sensor does not provide a valid signal to controller	<ul style="list-style-type: none"> • Sensor improperly wired or open • Incorrect setting of sensor type • Calibration corrupt 	<ul style="list-style-type: none"> • Correct wiring or replace sensor • Match setting to sensor used • Check calibration of controller
Limit won't clear or reset	Limit will not clear or reset with keypad or digital input	<ul style="list-style-type: none"> • Sensor input is out of limit set point range • Limit set point is incorrect • Digital input function is incorrect 	<ul style="list-style-type: none"> • Correct cause of sensor input out of limit range • Set limit set point to correct trip point • Set digital input function and source instance
Limit Error	Limit state cannot be determined due to lack of sensor input, limit will trip	<ul style="list-style-type: none"> • Sensor improperly wired or open • Incorrect setting of sensor type • Calibration corrupt 	<ul style="list-style-type: none"> • Correct wiring or replace sensor • Match setting to sensor used • Check calibration of controller
Limit Low	Sensor input below low limit set point	<ul style="list-style-type: none"> • Temperature is less than limit set point • Limit outputs latch and require reset • Incorrect alarm set point 	<ul style="list-style-type: none"> • Check cause of under temperature • Clear limit • Establish correct limit set point

Indication	Description	Possible Cause(s)	Corrective Action
Limit High	Sensor input above high limit set point	<ul style="list-style-type: none"> • Temperature is greater than limit set point • Limit outputs latch and require reset • Incorrect alarm set point 	<ul style="list-style-type: none"> • Check cause of over temperature • Clear limit • Establish correct limit set point
Loop Open Error	Open Loop Detect is active and the process value did not deviate by a user-selected value in a user specified period with PID power at 100%.	<ul style="list-style-type: none"> • Setting of Open Loop Detect Time incorrect • Setting of Open Loop Detect Deviation incorrect • Thermal loop or process is open • Open Loop Detect function not required but activated 	<ul style="list-style-type: none"> • Set correct Open Loop Detect Time for application • Set correct Open Loop Deviation value for application • Determine cause of open thermal loop: misplaced sensors, load failure, loss of power to load, etc. • Deactivate Open Loop Detect feature
Loop Reversed Error	Open Loop Detect is active and the process value is headed in the wrong direction when the output is activated based on deviation value and user-selected value.	<ul style="list-style-type: none"> • Setting of Open Loop Detect Time incorrect • Setting of Open Loop Detect Deviation incorrect • Output programmed for incorrect function • Thermocouple sensor wired in reverse polarity 	<ul style="list-style-type: none"> • Set correct Open Loop Detect Time for application • Set correct Open Loop Deviation value for application • Set output function correctly • Wire thermocouple correctly, (red wire is negative)
Ramping	Controller is ramping to new set point	<ul style="list-style-type: none"> • Ramping feature is activated • Profile is active 	<ul style="list-style-type: none"> • Disable ramping feature if not required • Terminate profile if not required
Autotuning	Controller is autotuning the control loop	<ul style="list-style-type: none"> • User started the autotune function • Digital input is set to start autotune 	<ul style="list-style-type: none"> • Wait until autotune completes or disable autotune feature • Connect the digital input to function other than autotune, if desired

Indication	Description	Possible Cause(s)	Corrective Action
No heat/cool action	Output does not activate load	<ul style="list-style-type: none"> • Output function is incorrectly set • Control mode is incorrectly set • Algorithm is set off • Output is incorrectly wired • Load, power or fuse is open • Control set point is incorrect • Incorrect controller model for application 	<ul style="list-style-type: none"> • Set output function correctly • Set control mode appropriately (Open vs Closed Loop) • Set heat/cool algorithm to on/off or PID. • Correct output wiring • Correct fault in system • Set control set point in appropriate control mode and check source of set point: remote, idle, profile, closed loop, open loop • Obtain correct controller model for application
No Display	No display indication	<ul style="list-style-type: none"> • Power to controller is off • Fuse open • Breaker tripped • Safety interlock switch open • Separate system limit control activated • Wiring error • Incorrect voltage to controller 	<ul style="list-style-type: none"> • Turn on power • Replace fuse • Reset breaker • Close interlock switch • Reset limit • Correct wiring issue • Apply correct voltage, check part number

Indication	Description	Possible Cause(s)	Corrective Action
No Serial Communication	Cannot establish serial communications with the controller	<ul style="list-style-type: none"> • Address parameter incorrect • Incorrect protocol selected • Baud rate incorrect • Parity incorrect • Wiring error • EIA-485 converter issue • Incorrect computer or PLC communications port • Incorrect software setup • Wires routed with power cables • Termination resistor may be required 	<ul style="list-style-type: none"> • Set unique addresses on network • Match protocol between devices • Match baud rate between devices • Match parity between devices • Correct wiring issue • Check settings or replace converter • Set correct communication port • Correct software setup to match controller • Route communications wires away from power wires • Place 120 Ω resistor across EIA-485 on last controller
Process doesn't control to set point	Process is unstable or never reaches set point	<ul style="list-style-type: none"> • Controller not tuned correctly • Control mode is incorrectly set • Control set point is incorrect 	<ul style="list-style-type: none"> • Perform autotune or manually tune system • Set control mode appropriately (Open vs Closed Loop) • Set control set point in appropriate control mode and check source of set point: remote, idle, profile, closed loop, open loop
Temperature runaway	Process value continues to increase or decrease past set point.	<ul style="list-style-type: none"> • Controller output incorrectly programmed • Thermocouple reverse wired • Controller output wired incorrectly • Short in heater or wiring • Power controller connection to controller defective • Controller output defective 	<ul style="list-style-type: none"> • Verify output function is correct (heat or cool) • Correct sensor wiring (red wire negative) • Verify and correct wiring • Replace heater or repair wiring • Replace or repair power controller • Replace or repair controller

Indication	Description	Possible Cause(s)	Corrective Action
Heater Error	Heater Error	<ul style="list-style-type: none"> • Current through load is above current trip set point • Current through load is below current trip set point 	<ul style="list-style-type: none"> • Check that the load current is proper. Correct cause of over current and/or ensure current trip set point is correct. • Check that the load current is proper. Correct cause of undercurrent and/or ensure current trip set point is correct.
Current Error	Load current incorrect.	<ul style="list-style-type: none"> • Shorted solid-state or mechanical relay • Open solid-state or mechanical relay • Current transformer load wire associated to wrong output • Defective current transformer or controller • Noisy electrical lines 	<ul style="list-style-type: none"> • Replace relay • Replace relay • Route load wire through current transformer from correct output, select the output that is driving the load. • Replace or repair sensor or controller • Route wires appropriately, check for loose connections, add line filters
Menus inaccessible	Unable to access screens or particular parameters of interest	<ul style="list-style-type: none"> • Security set to incorrect level 	<ul style="list-style-type: none"> • Verify password accuracy • Login using appropriate credentials
Wrong time and date	Real time clock resets every time power is lost	<ul style="list-style-type: none"> • Battery not installed • Polarity reversed • Bad battery 	<ul style="list-style-type: none"> • Install battery per instructions • Place battery with positive side of battery facing up in the holder • Replace battery

Replacing the Battery

All F4T controllers are equipped with a field replaceable battery. In a worse case scenario, the battery should be replaced every 7.5 years. If a replacement is required, the part number for the battery is BR 2032. The Watlow part number for the battery is: 0830-0858-0000

Identifying the battery location:

1. Orient the controller as shown in the picture below.
2. Notice that the battery compartment is located just below the two USB.



Removing the old battery:

1. Ensure all power is off to the F4T.
2. Insert a small screwdriver into the hole provided on the side of the controller as shown below.
3. Place screwdriver into the bottom of the white battery holder and apply downward pressure to slide the battery out of the housing. Once removed, make note of the polarity as seated in the holder.

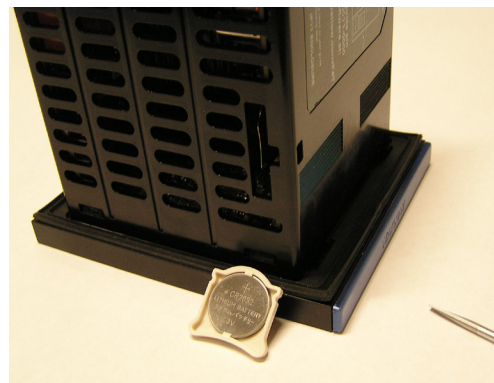
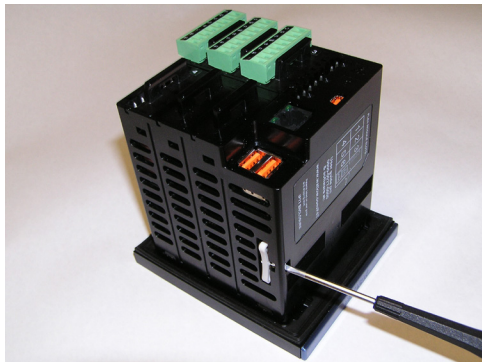

Installing a new battery:

1. Observing polarity (as shown in the previous graphic), insert the new battery from the bottom of the holder (2 open slots - red circles as shown in picture below).

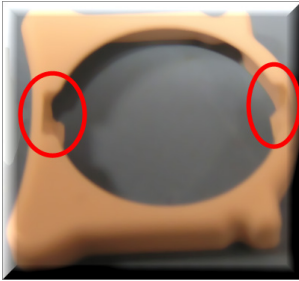

2. Insert the battery perpendicular to the plastic housing.



3. Turn and secure the battery so that it sits under the tabs located on the top of the holder.



4. Insert the holder into the controller housing with the positive side of the battery oriented to the left as shown below.

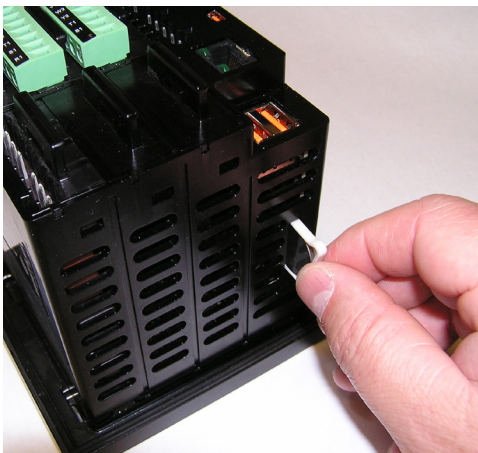

Note:

If the battery is fully discharged it may be disposed of in normal municipal waste. Because there will always be some residual metals remaining in the battery Watlow recommends that this battery be recycled.

6

Chapter 6: Appendix

F4T Base Specifications

Line Voltage/Power (Minimum/Maximum Ratings)

- High voltage option: 100 to 240V~ (ac) 50/60Hz
- Low voltage option: 24 to 28V (~ ac) (= dc), 50/60Hz
- Power consumption: 23 W, 54VA maximum

Environment

- NEMA 4X/IP65 - front panel mount configuration only
- 0 to 122°F (-18 to 50°C) operating temperature
- -40 to 185°F (-40 to 85°C) storage temperature
- 0 to 90% RH, non-condensing

Agency Approvals

- UL®/EN 61010 Listed, File E185611 QUXX
- UL® 508 Reviewed
- CSA CC.C#14, File 158031
- FM Class 3545 (configurations with limit modules)
- AMS 2750 E compliant: Analog input process values. Tip: Maximize field calibration accuracy and uniformity by using advanced F4T features such as Calibration Offset and Linearization Function Blocks. Refer to user manual for details.
- RoHS by design, China RoHS Level 2, W.E.E.E.
- CE
- Windows® Hardware Certification

User Interface

- 4.3 inch TFT PCAP color graphic touch screen
- LED backlife >50K hours
- 4 keys: Home, Main Menu, Back, Help

Control Loops

- 1 to 4 PID or ON-OFF control loops
- 0 to 6 Limit loops
- User-selectable action: heat, cool or heat/cool
- Auto-tune with TRU-TUNE+ adaptive control

Control Loops and Over-temperature Limits

- Input sampling: 10Hz
- Output update: 10Hz

Communications

- Ethernet Modbus® TCP
 - Isolated communications
-

Profile Ramp and Soak

- Profile engine affects 1 to 4 loops in sync
 - 40 profiles with 50 steps per profile
-

Data Logging

- User selectable parameters: Up to a maximum of 128 active parameters depending on configuration
 - Logging interval: Programmable increments between 0.1 seconds and 60 minutes if logging to internal memory. Logging directly to USB; 1.0 seconds to 60 minutes
 - File types: .CSV for standard data logging or proprietary format for encrypted data log option
 - Storage: 80MB internal memory or to USB memory stick
 - File transfer: Internal memory to USB host port or to Ethernet Modbus® TCP
 - Transfer options: On demand by user or user programmable based on when a new data log file record is available. Utilizes TFTP and Samba protocols
 - Record: Date and time stamped
-

Batch Processing with Bar Code Data Entry Via USB Scanner

- Compatible with many bar code types including Code 128, Code 39, Extended Code 39, Data Matrix, Interleaved 2 of 5, ISSN, SISAC, LOGMARS, QR, UCC/EAN-128 (GS1-128, UPC-A & E)
 - Compatible with most USB scanner types such as Zebra DS4308, DS2208, LI2208 and LS2208
 - USB port provides 500mA max. power supply for bar code scanner/base charging
 - Display can show bar code fields up to a maximum length of 48 characters. Characters might wrap to 2 rows after 24 characters
 - Part-Profile list entries - approximately 1,000 typical length part numbers of 15 characters each can be stored. Can easily import different part files via USB thumb drive connection to cover a higher quantity range of part lists
 - Program the bar code scanner to add an enter key (carriage return feed) at the end of each bar code data field sent to F4T/D4T. Refer to USB scanner user manual.
-

Trending

- 4 user programmable charts
- 6 pens available per chart
- View analog sensors, process values, set points and power

Number of Function Blocks by Ordering Option

Function Block	Basic	Set 1	Set 2
Alarm	6	8	14
Compare	None	4	16
Counter	None	4	16
Linearization	4	4	8
Logic	None	12	24
Math	None	12	24
Process Value	4	4	8
Special Output Function	None	2	4
Timer	None	6	16
Variable	4	12	24

Real Time Clock with Battery Backup

- Accuracy (typical): +/-3ppm over -15 to 50°C
- Typical battery life: 10 years at 77°F (25°C)
- Field replaceable lithium battery

Compare

- Greater than, less than, equal, not equal, greater than or equal, less than or equal

Counters

- Counts up or down, loads predetermined value on load signal

Linearization

- Interpolated or stepped

Logic

- And, nand, or, nor, equal, not equal, latch, flip-flop

Math

- Average, process scale, switch over, deviation scale, differential (subtract), ratio (divide), add, multiply, absolute difference, minimum, maximum, square root, sample and hold, pressure-to-altitude and dew point

Process Value

- Sensor backup, average, crossover, wet bulb-dry bulb, switch over, differential (subtract), ratio (divide), add, multiply, absolute difference, minimum, maximum, square root, altitude, Vaisala® relative humidity and pressure-to-altitude

Special Output Function

- Compressor control (cool and/or dehumidify with single compressor), motorized valve, sequencer

Timers

- On pulse, delay, one shot or retentive

Variable

- User value for digital or analog variable

F4T Base Ordering Information

Base includes: Battery Backup, Real-Time Clock, 4.3 inch color graphical touch panel, 2 USB host, USB configuration port, standard bus, wired Ethernet Modbus[®] TCP. SCPI protocol and backwards compatible Modbus[®] for select key SERIES F4D/P/S parameters (see the F4T Setup and Operation User's Guide)

Part Number

① ②	③ Base Type	④ Application Type	⑤ Data Logging	⑥ Power Supply Connector & Voltage, Logo	⑦ Profiles & Function Blocks	⑧ ⑨ Future Options	⑩ ⑪ Documentation, Accent Bar, Replacement Connector & Custom	⑫ Control Algorithms	⑬ ⑭ ⑮ Preloaded Flex Modules
F4	T					AA			

③ Base Type	
T =	Touch Screen

④ Application Type	
1 =	Standard
X =	Custom, contact factory

⑤ Data Logging and Graphic Trend Charts	
A =	None
B =	Graphical trend chart
J =	Data logging
K =	Data logging with encrypted files
L =	Data logging with graphical trend chart
M* =	Data logging with encrypted files, graphical trend charts and batch processing with bar code data entry.

*Must also order digit 7: Profiles option D, E or F for batch processing with bar code data entry feature to be enabled.

⑥ Power Supply Connector & Voltage, Logo			
	Power Supply	Connector	Watlow Logo
1 =	100 to 240Vac	Right angle (standard)	Yes
2 =	100 to 240Vac	Right angle (standard)	No
3 =	100 to 240Vac	Front screw	Yes
4 =	100 to 240Vac	Front screw	No
5 =	24 to 28Vac or Vdc	Right angle (standard)	Yes
6 =	24 to 28Vac or Vdc	Right angle (standard)	No
7 =	24 to 28Vac or Vdc	Front screw	Yes
8 =	24 to 28Vac or Vdc	Front screw	No

⑦ Profiles and Function Blocks					
	Profiles		Function Blocks		
	None	40 Profiles	Basic Set	Set 1	Set 2
A =	X		X		
B =	X			X	
C =	X				X
D =		X	X		
E =		X		X	
F =		X			X

⑩ ⑪ Documentation, Accent Bar, Replacement Connector & Custom					
	Documentation DVD/QSG	Decorated Brush Aluminium Accent Bar			
		Gray	Blue	Red	None
1A =	Yes	X			
1B =	Yes		X		
1C =	Yes			X	
1D =	Yes				X
1E =	No	X			
1F =	No		X		
1G =	No			X	
1H =	No				X
1J =	Replacement connectors only - for the model number entered				
XX =	Contact factory, other custom-firmware, preset parameters, locked code, logo				

⑫ Control Algorithms		
	Control Loop	Cascade Loop
1 =	1	0
2 =	2	0
3 =	3	0
4 =	4	0
5 =	0	0
6 =	0	1
7 =	1	1
8 =	2	1
9 =	3	1
A =	0	2
B =	1	2
C =	2	2

Note: Each control loop algorithm will require 1 universal or thermistor input from a flex module.

Note: Each cascade loop algorithm will require 2 universal or thermistor inputs from flex modules.

⑬ ⑭ ⑮ Populated Flex Modules	
AAA =	No populated flex modules
XXX =	Contact factory - Populated flex modules
Note: If AAA is selected you will need to order Flex Modules (FM) next to account for input and output hardware.	

Flex Modules and Limit I/O Specifications

1 Universal Input

- Thermocouple, grounded or ungrounded sensors
 - >20MΩ input impedance
- Max. of 2KΩ source resistance
- RTD 2 or 3 wire, platinum, 100Ω and 1000Ω @ 32°F (0°C) calibration to DIN curve (0.00385Ω/Ω/°C)
 - Maximum lead resistance 10Ω
- Process, 0-20mA @ 100Ω ,or 0-10V = (dc) @ 20kΩ input impedance; scalable, 0 - 50mV

Voltage Input Ranges

- Accuracy ±10mV ±1 LSD at standard conditions
- Temperature stability ±100 PPM/°C maximum

Milliamp Input Ranges

- Accuracy ±20μA ±1 LSD at standard conditions
- Temperature stability ±100 PPM/°C maximum

Resolution Input Ranges

- 0 to 10V: 200 μV nominal
- 0 to 20 mA: 0.5 mA nominal

- Potentiometer: 0 to 1,200Ω
- Inverse scaling

Input Type	Max Error @ 25 Deg C	Accuracy Range Low	Accuracy Range High	Units
J	±1.75	0	750	Deg C
K	±2.45	-200	1250	Deg C
T (-200 to 350)	±1.55	-200	350	Deg C
N	±2.25	0	1250	Deg C
E	±2.10	-200	900	Deg C
R	±3.9	0	1450	Deg C
S	±3.9	0	1450	Deg C
B	±2.66	870	1700	Deg C
C	±3.32	0	2315	Deg C
D	±3.32	0	2315	Deg C
F (PTII)	±2.34	0	1343	Deg C
RTD, 100 ohm	±2.00	-200	800	Deg C
RTD, 1000 ohm	±2.00	-200	800	Deg C
mV	±0.05	0	50	mV
Volts	±0.01	0	10	Volts
mAdc	±0.02	2	20	mAmps DC
mAac	±5	-50	50	mAmps AC
Potentiometer, 1K range	±1	0	1000	Ohms

Operating Range		
Input Type	Range Low	Range High
J	-210 °C	1200 °C
K	-270 °C	1371 °C
T	-270 °C	400 °C
N	-270 °C	1300 °C
E	-270 °C	1000 °C
R	-50 °C	1767 °C
S	-50 °C	1767 °C
B	-50 °C	1816 °C
C	0 °C	2315 °C
D	0 °C	2315 °C
F (PTII)	0 °C	1343 °C
RTD (100 ohm)	-200 °C	800 °C
RTD (1000 ohm)	-200 °C	800 °C
mV	-50	50
Volts	0	10
mAdc	0	20
mAac	-50	50
Potentiometer, 1K range	0	1200 ohms
Resistance, 5K range	0	5000 ohms
Resistance, 10K range	0	10000 ohms
Resistance, 20K range	0	20000 ohms
Resistance, 40K range	0	40000 ohms

1 Thermistor Input

Input Type	Max Error @ 25 Deg C	Accuracy Range Low	Accuracy Range High	Units
Thermistor, 5K range	±5	0	5000	Ohms
Thermistor, 10K range	±10	0	10000	Ohms
Thermistor, 20K range	±20	0	20000	Ohms
Thermistor, 40K range	±40	0	40000	Ohms

- 0 to 40KΩ, 0 to 20KΩ, 0 to 10KΩ, 0 to 5KΩ
- 2.252KΩ and 10KΩ base at 77°F (25°C)
- Linearization curves built in
- Third party Thermistor compatibility requirements

Base R @ 25C	Alpha Techniques	Beta THERM	YSI
2.252K	Curve A	2.2K3A	004
10K	Curve A	10K3A	016
10K	Curve C	10K4A	006

1 Temperature Input

- Thermocouple, grounded or ungrounded sensors
 - >20M Ω input impedance
 - Max. of 2K Ω source resistance
 - RTD 2 wire, platinum, 100 Ω and 1000 Ω @ 32 $^{\circ}$ F (0 $^{\circ}$ C) calibration to DIN curve (0.00385 Ω / Ω / $^{\circ}$ C)
 - Maximum lead resistance 10 Ω
-

1 Digital Input

- Digital input update rate 10Hz
 - **DC voltage**
 - Max. input 36V @ 3mA
 - Min. high state 3V at 0.25mA
 - Max. low state 2V
 - **Dry contact**
 - Min. open resistance 10K Ω
 - Max. closed resistance 50 Ω
 - Max. short circuit 13mA
-

1 Current Transformer Input

- Accepts 0-50mA signal (user programmable range)
 - Displayed operating range and resolution can be scaled and are user programmable
 - Current input range: 0 to 50mA ac, 100 Ω input impedance
 - Response time: 1 second max., accuracy \pm 1mA typical
 - Requires optional current transformer, Watlow part number: 16-0246
-

Switched DC Output

- Switched dc = 22 to 32V $\overline{=}$ (dc) @ 30mA per output, 40mA per pair (option CC)
-

Open Collector Output

- Switched dc/open collector = 32V $\overline{=}$ (dc) max. @ 100mA max. current sink
-

Solid-State Relay Output

- Form A, 1A at 50 $^{\circ}$ F (10 $^{\circ}$ C) to 0.5A at 149 $^{\circ}$ F (65 $^{\circ}$ C), 0.5A at 24V \sim (ac) min., 264V \sim (ac) max., opto-isolated, without contact suppression, 20VA pilot duty at 120/240 V \sim (ac)
-

Form A Electromechanical Relay Output

- 5A, 24 to 240V \sim (ac) or 30V $\overline{=}$ (dc) max., resistive load, 100,000 cycles at rated load, requires a min. load of 20mA at 24V, 125VA pilot duty at 120/240 V \sim (ac) or 25 VA at 24 V \sim (ac)
-

Form C Electromechanical Relay Output

- 5A, 24 to 240V \sim (ac) or 30V $\overline{=}$ (dc) max., resistive load, 100,000 cycles at rated load, requires a min. load of 20mA at 24V, 125VA pilot duty at 120/240 V \sim (ac) or 25 VA at 24 V \sim (ac)
-

NO-ARC Relay Output

- Form A, 12A at 122 $^{\circ}$ F (50 $^{\circ}$ C), 85 to 264V \sim (ac), no V $\overline{=}$ (dc), resistive load, 2 million cycles at rated load
-

Universal Process/Retransmit Output

- Universal process/retransmit, Output range selectable:
 - 0 to 10V \Rightarrow (dc) into a min. 1,000 Ω load
 - 0 to 20mA into max. 800 Ω load

Resolution

- dc ranges: 2.5mV nominal resolution
- mA ranges: 5 μ A nominal resolution

Calibration Accuracy

- dc ranges: \pm 15 mV
- mA ranges: \pm 30 μ A

Temperature Stability

- 100 ppm/ $^{\circ}$ C

Flex Module - Mixed I/O Ordering Information

Part Number

① ②	③ Module ID Type	④ Future Option	⑤ Input Hardware	⑥ ⑦ Output Hardware Options	⑧ Future Option	⑨ Future Options	⑩ Custom Options and Connectors	⑪ ⑫ Custom Options - Firmware, Overlay, Preset Parameters, Locked Code
FM	M	A	-		A	-	A	

③ Module Type
M = Mixed I/O

⑤ Input Hardware
A = None
U = Universal input - T/C, RTD 2- or 3-wire, 0-10VDC, 0-20mA
T = Thermistor input
C = Current transformer input

⑥ ⑦ Output Hardware Options	Output 1	Output 2
AA =	None	None
AJ =	None	Mechanical relay 5A, Form A
AK =	None	SSR Form A, 0.5A
CA =	Switched dc/open collector	None
CH =	Switched dc/open collector	NO-ARC 12A power control
CC =	Switched dc/open collector	Switched dc
CJ =	Switched dc/open collector	Mechanical relay 5A, Form A
CK =	Switched dc/open collector	SSR Form A, 0.5A
EA =	Mechanical relay 5A, Form C	None
EH =	Mechanical relay 5A, Form C	NO-ARC 12A power control
EC =	Mechanical relay 5A, Form C	Switched dc
EJ =	Mechanical relay 5A, Form C	Mechanical relay 5A, Form A
EK =	Mechanical relay 5A, Form C	SSR Form A, 0.5A
FA =	Universal process/retransmit	None
FC =	Universal process/retransmit	Switched dc
FJ =	Universal process/retransmit	Mechanical relay 5A, Form A
FK =	Universal process/retransmit	SSR Form A, 0.5A
KH =	SSR Form A, 0.5A	NO-ARC 12A power control
KK =	SSR Form A, 0.5A	SR Form A, 0.5A

⑩ Custom Options and Connectors
A = Right angle screw connector (standard)
F = Front screw connector

⑪ ⑫ Custom Options - Firmware, Overlay, Preset Parameters, Locked Code
AA = Standard with quick start guide
AB = Standard without quick start guide
AC = Replacement connectors hardware only - for the entered model number
XX = Custom

Flex Module - Limit Ordering Information

Part Number

① ②	③ Module ID Type	④ Future Option	⑤ ⑥ ⑦ Input and Output Hardware	⑧ Future Option	⑨ Future Options	⑩ Custom Options and Connectors	⑪ ⑫ Custom Options - Firmware, Overlay, Preset Parameters, Locked Code
FM	L	A	-	A	-	A	

③	Module Type
L =	Limit

⑤ ⑥ ⑦	Input and Output Hardware			
	Functions	Auxiliary Output Hardware	Limit Output Hardware	Auxiliary Input Hardware
LCJ =	Limit control with universal input	Switched dc/ open collector	Mechanical relay 5A, Form A	None
LEJ =	Limit control with universal input	Mechanical relay 5A, Form C	Mechanical relay 5A, Form A	None
LAJ =	Limit control with universal input	None	Mechanical relay 5A, Form A	None
MCJ =	Limit control with thermistor input	Switched dc/ open collector	Mechanical relay 5A, Form A	None
MEJ =	Limit control with thermistor input	Mechanical relay 5A, Form C	Mechanical relay 5A, Form A	None
MAJ =	Limit control with thermistor input	None	Mechanical relay 5A, Form A	None
YEB =	Limit control with temperature input	None	Mechanical relay 5A, Form C	Single digital input (limit reset)

⑩	Custom Options and Connectors
A =	Right angle screw connector (standard)
F =	Front screw connector

⑪ ⑫	Custom Options - Firmware, Overlay, Preset Parameters, Locked Code
AA =	Standard with quick start guide
AB =	Standard without quick start guide
AC =	Replacement connectors hardware only - for the entered model number
XX =	Custom

Flex Modules - High Density I/O Specifications

4 Universal Inputs

- Thermocouple, grounded or ungrounded sensors
- >20M Ω input impedance
- Max. of 2K Ω source resistance
- RTD 2 or 3 wire, platinum, 100 Ω and 1000 Ω @ 32 $^{\circ}$ F (0 $^{\circ}$ C) calibration to DIN curve (0.00385 Ω / Ω / $^{\circ}$ C)
- Process, 0-20mA @ 100 Ω ,or 0-10V \Rightarrow (dc) @ 20k Ω input impedance; scalable, 0 - 50mV

Voltage Input Ranges

- Accuracy ± 10 mV ± 1 LSD at standard conditions
- Temperature stability ± 100 PPM/ $^{\circ}$ C maximum

Milliamp Input Ranges

- Accuracy ± 20 μ A ± 1 LSD at standard conditions
- Temperature stability ± 100 PPM/ $^{\circ}$ C maximum

Resolution Input Ranges

- 0 to 10V: 200 μ V nominal
- 0 to 20 mA: 0.5 mA nominal

- Potentiometer: 0 to 1,200 Ω
- Inverse scaling

Input Type	Max Error @ 25 Deg C	Accuracy Range Low	Accuracy Range High	Units
J	±1.75	0	750	Deg C
K	±2.45	-200	1250	Deg C
T (-200 to 350)	±1.55	-200	350	Deg C
N	±2.25	0	1250	Deg C
E	±2.10	-200	900	Deg C
R	±3.9	0	1450	Deg C
S	±3.9	0	1450	Deg C
B	±2.66	870	1700	Deg C
C	±3.32	0	2315	Deg C
D	±3.32	0	2315	Deg C
F (PTII)	±2.34	0	1343	Deg C
RTD, 100 ohm	±2.00	-200	800	Deg C
RTD, 1000 ohm	±2.00	-200	800	Deg C
mV	±0.05	0	50	mV
Volts	±0.01	0	10	Volts
mAdc	±0.02	2	20	mAmps DC
mAac	±5	-50	50	mAmps AC
Potentiometer, 1K range	±1	0	1000	Ohms

Operating Range		
Input Type	Range Low	Range High
J	-210 °C	1200 °C
K	-270 °C	1371 °C
T	-270 °C	400 °C
N	-270 °C	1300 °C
E	-270 °C	1000 °C
R	-50 °C	1767 °C
S	-50 °C	1767 °C
B	-50 °C	1816 °C
C	0 °C	2315 °C
D	0 °C	2315 °C
F (PTII)	0 °C	1343 °C
RTD (100 ohm)	-200 °C	800 °C
RTD (1000 ohm)	-200 °C	800 °C
mV	-50	50
Volts	0	10

Operating Range (cont.)		
Input Type	Range Low	Range High
mAdc	0	20
mAac	-50	50
Potentiometer, 1K range	0	1200
Resistance, 5K range	0	5000
Resistance, 10K range	0	10000
Resistance, 20K range	0	20000
Resistance, 40K range	0	40000

4 Thermistor Inputs

Input Type	Max Error @ 25 Deg C	Accuracy Range Low	Accuracy Range High	Units
Thermistor, 5K range	±5	0	5000	Ohms
Thermistor, 10K range	±10	0	10000	Ohms
Thermistor, 20K range	±20	0	20000	Ohms
Thermistor, 40K range	±40	0	40000	Ohms

- 0 to 40KΩ, 0 to 20KΩ, 0 to 10KΩ, 0 to 5KΩ
- 2.252KΩ and 10KΩ base at 77°F (25°C)
- Linearization curves built in
- Third party Thermistor compatibility requirements

Base R @ 25C	Alpha Techniques	Beta THERM	YSI
2.252K	Curve A	2.2K3A	004
10K	Curve A	10K3A	016
10K	Curve C	10K4A	006

3 Universal Process/Retransmit Outputs

- Universal process/retransmit, Output range selectable:
 - 0 to 10V \Rightarrow (dc) into a min. 4,000Ω load
 - 0 to 20mA into max. 400Ω load

Resolution

- dc ranges: 2.5mV nominal resolution
- mA ranges: 5 μA nominal resolution

Calibration Accuracy

- dc ranges: ±15 mV
- mA ranges: ±30 μA

Temperature Stability

- 100 ppm/°C

3 Mechanical Relay Outputs

- 2 Form C relays, 1 Form A relay. Form A shares common with 1 Form C relay
- Each relay is rated at 5A, 24 to 240V~ (ac) or 30V \Rightarrow (dc)max., resistive load, 100,000 cycles at rated load. Requires a min. load of 20mA at 24V, 125 VA pilot duty at 120/240 V~ (ac) or 25 VA at 24 V~ (ac)

4 Mechanical Relay Outputs

- Form A, 5A each, 24 to 240V~ (ac) or 30V= (dc)max., resistive load, 100,000 cycles at rated load. Requires a min. load of 20mA at 24V, 125 VA pilot duty at 120/240 V~ (ac) or 25 VA at 24 V~ (ac)

2 Solid-State Relays

- Form A, 10A max. each SSRs combined at 24V~ (ac) min., 264V~ (ac) max., opto-isolated, without contact suppression, max. resistive load 10A per output at 240V~ (ac), max. 20A per card at 122°F (50°C), max.

4 Solid-State Relays

- Two pairs of SSRs, each pair shares a common
- Form A, 24V~ (ac) min., 264V~ (ac) max., opto-isolated, without contact suppression, resistive load 2A per output at 240V~ (ac), max. See table for max. current per output
- 50 VA pilot duty at 120/240 V~ (ac)

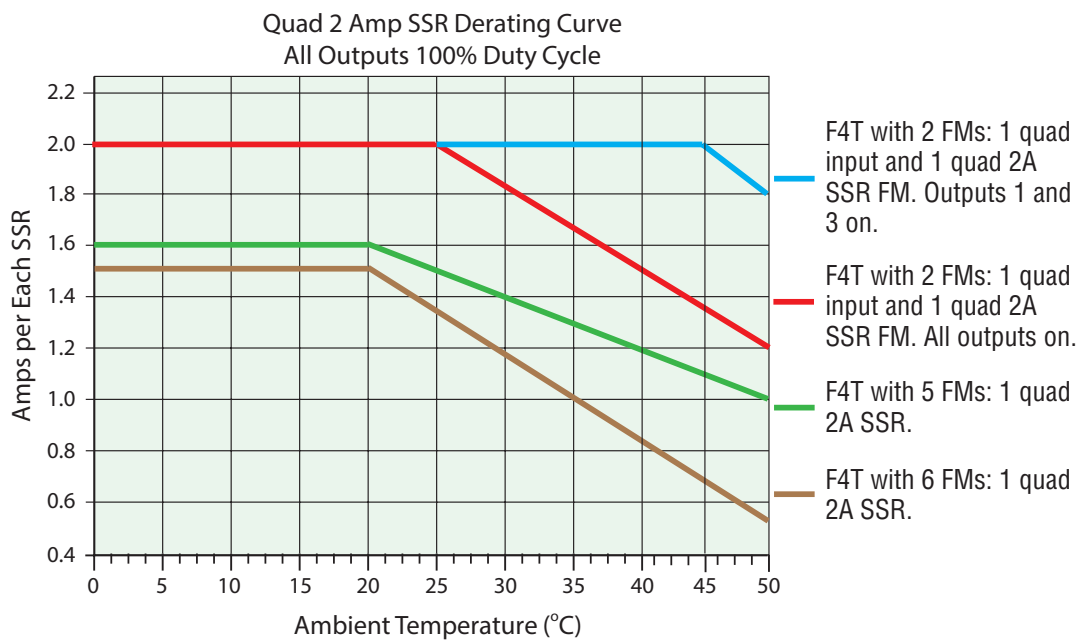

6 Digital Input/Output Option - (6 DIO)

- Digital input update rate 10Hz
 - DC voltage
 - Max. input 36V @ 3mA
 - Min. high state 3V at 0.25mA
 - Max. low state 2V
 - Dry contact
 - Min. open resistance 10KΩ
 - Max. closed resistance 50Ω
 - Max. short circuit 13mA
- Digital output update rate 10Hz
 - User selectable Switched DC output: 5V= (dc) at 130mA or 19 to 22V= (dc) at 80mA
 - Open Collector output: 32V= (dc) at 1.5A maximum, 8A maximum per 6 outputs combined

Flex Module - High Density Ordering Information

Part Number

① ②	③ Module ID Type	④ Future Option	⑤ Input and Output Hardware	⑥ ⑦ ⑧ Future Option	⑨ Future Options	⑩ Custom Options and Connectors	⑪ ⑫ Custom Options - Firmware, Overlay, Preset Parameters, Locked Code
FM	H	A	-	AAA	-	A	

③ Module Type	
H =	High Density I/O

⑤ Input and Output Hardware	
R =	4 universal inputs (T/C, RTD 2-wire, 0-10VDC, 0-20mA)
P =	4 thermistor inputs
C =	6 digital I/O
F =	3 universal process/retransmit outputs
B =	3 mechanical relay 5A, 2 Form C and 1 Form A (Form A shares a common with one Form C)
J =	4 mechanical relay 5A, Form A
K =	2 SSRs 10A
L =	4 SSRs at 2A each. SSRs grouped in 2 pairs with each pair sharing a common

Flex Module - Communications Ordering Information

Part Number

① ②	③ Module ID Type	④ Future Option	⑤ Comm. Option	⑥ ⑦ ⑧ Future Option	⑨ Future Options	⑩ Custom Options and Connectors	⑪ ⑫ Custom Options - Firmware, Overlay, Preset Parameters, Locked Code
FM	C	A	-	2	-	A	

⑤ Communication Option	
2 =	Modbus® RTU 232/485*

⑩ Custom Options and Connectors	
A =	Right angle screw connector (standard)
F =	Front screw connector

⑪ ⑫ Custom Options - Firmware, Overlay, Preset Parameters, Locked Code	
AA =	Standard with quick start guide
AB =	Standard without quick start guide
AC =	Replacement connectors hardware only - for the entered model number
XX =	Custom

Declaration of Conformity

Series F4T



WATLOW Electric Manufacturing Company

ISO 9001 since 1996.

1241 Bundy Blvd.
Winona, MN 55987 USA

Declares that the following products:

Designation: **Series F4T ¼ DIN Control**
Model Numbers: F4T X X (1 to 8) – X AA XX X – XXX X = any number or letter.
Classification: Process Controller Base Installation Category II,
rated IP65 or IP40 if flush mount option is used.
Rated Voltage and Frequency: High Voltage 100 – 240 Vac 50/60 Hz, F4TXX(1, 2, 3, 4)
Low Voltage 24 – 28 Vac/dc 50/60 Hz, F4TXX(5, 6, 7, 8)
Rated Power Consumption: Up to 23 Watts with six modules loaded.

Only the front display is considered part of the ultimate enclosure, the unit is considered an open type process control, it requires an ultimate enclosure and at least one **Watlow EZ-ZONE® FM “Flex Module”** to have a useful function. All Flex Modules were tested as part of F4T system for compliance with the following directives.

2004/108/EC Electromagnetic Compatibility Directive

EN 61326-1	2013	Electrical equipment for measurement, control and laboratory use – EMC requirements (Industrial Immunity, Group 1 Class A ¹ Emissions).
EN 55011	2010	
EN 61000-4-2	2009	Electrostatic Discharge Immunity
EN 61000-4-3	2010	Radiated Field Immunity
EN 61000-4-4	2012	Electrical Fast-Transient / Burst Immunity
EN 61000-4-5	2006	Surge Immunity
EN 61000-4-6	2009	Conducted Immunity
EN 61000-4-11	2004	Voltage Dips, Short Interruptions and Voltage Variations Immunity
EN 61000-3-2	2009	Harmonic Current Emissions
EN 61000-3-3 ²	2013	Voltage Fluctuations and Flicker
SEMI F47	2000	Specification for Semiconductor Sag Immunity Figure R1-1

¹NOTE: Not for use in Commercial or Residential locations without additional emissions protection.

²NOTE: To comply with flicker requirements cycle time may need to be up to 160 seconds if load current is at 15A, or the maximum source impedance needs to be < 0.13Ω. Unit power of F4T model complies with 61000-3-3 requirements.

2006/95/EC Low-Voltage Directive

EN 61010-1	2010	Safety Requirements of electrical equipment for measurement, control and laboratory use. Part 1: General requirements
------------	------	---

Compliant with 2011/65/EC RoHS2 Directive



Per 2002/96/EC W.E.E Directive and 2006-66-EC Battery Directive Please Recycle Properly.

Joe Millanes
Name of Authorized Representative

Winona, Minnesota, USA
Place of Issue

Director of Operations
Title of Authorized Representative

July 2014
Date of Issue

Signature of Authorized Representative

Declaration of Conformity

Series EZ-ZONE® Flex Modules

WATLOW Electric Manufacturing Company

1241 Bundy Blvd.
Winona, MN 55987 USA

ISO 9001



since 1996.

Declares that the following products:

Designation:

Series EZ-ZONE® Flex Modules

Model Numbers:

FMLA-(LAJ, LCJ, LEJ, MAJ, MCJ, MEJ, YEB¹)A-A(A¹,F¹,B¹,G¹)XX

FMMA-X(A¹,C¹,E,F¹,K)(A¹,C¹,H,J,K)A-A(A¹,F¹,B¹,G¹)XX

FMHA-(R¹,P¹,C¹,F¹,B¹,J,K,L¹)AAA-A(A¹,F¹,B¹,G¹)XX

¹FMCA-XAAA-A(A¹,F¹,B¹,G¹)XX; **Note: X¹ = Any letter or number**

Classification:

FMLA, FMMA and FMHA are Process Control modules, FMCA are Communication modules; Modules are Integrated Controls in either **EZ-ZONE® CC or F4T Bases**; Modules are IP10 when properly installed.

Rated Voltage and Frequency:

Relay, SSR or No-Arc Control outputs 24 - 240 Vac 50/60 Hz, Switched DC, Process and communications; low voltage SELV

Rated Power Consumption:

At max 50°C, see manual for ratings at other ambient temperatures. No-arc relays 15A 1.C, Dual SSR module 1.C 10A each output, Mechanical relay 5A 125 VA, 25 VA at 24 Vac 1.B, Discreet SSR 1/2A 1.C 20VA, Quad SSR 1.C 0.7A 50 VA, Hex I/O 1.5A, all others SELV limited energy.

Flex Modules are considered components and have no function in and of themselves, it is only when installed in a **Watlow EZ-ZONE® CC or F4T** Base enclosure that they have useful function. Modules were tested as part of these systems for compliance with the following directives.

2004/108/EC Electromagnetic Compatibility Directive

EN 61326-1

2006

Electrical equipment for measurement, control and laboratory use – EMC requirements (Industrial Immunity, Class B Emissions).

2006/95/EC Low-Voltage Directive

EN 61010-1:2010 ED3

All FM's in all bases are compliant with this standard.

EN 60730-1:2011

EN 60730-2-9:2010

¹Compliant output options.

When in EZ-ZONE® CC Base.

Safety Requirements of electrical equipment for measurement, control and laboratory use. Part 1: General requirements

Automatic electrical controls for household and similar use – Particular requirements for temperature sensing controls.

Only certain output options comply with 60730 spacing and dielectric requirements, see order information for compatible models.

Compliant with 2011/65/EC RoHS2 Directive

Per 2002/96/EC W.E.E Directive and 2006-66-EC Battery Directive  Please Recycle Properly.

See the Declarations of Conformity for **Watlow EZ-ZONE® CC and F4T** models for further details on standards used for compliance.

Joe Millanes

Name of Authorized Representative

Winona, Minnesota, USA

Place of Issue

Director of Operations

Title of Authorized Representative

July 2014

Date of Issue

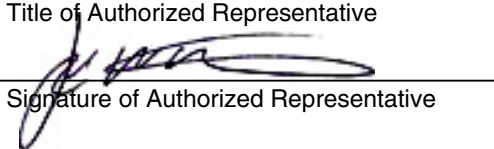
Signature of Authorized Representative

How to Reach Us

Corporate Headquarters

Watlow Electric Manufacturing Company
12001 Lackland Road
St. Louis, MO 63146
Sales: 1-800-WATLOW2
Manufacturing Support: 1-800-4WATLOW
Email: info@watlow.com
Website: www.watlow.com
From outside the USA and Canada:
Tel: +1 (314) 878-4600
Fax: +1 (314) 878-6814

Latin America

Watlow de México S.A. de C.V.
Av. Fundación No. 5
Col. Parques Industriales
Querétaro, Qro. CP-76130
Mexico
Tel: +52 442 217-6235
Fax: +52 442 217-6403

Europe

Watlow Plasmatech GmbH
Brennhoflehan - Kellau 156
431 Kuchl
Austria
Tel: +3 0244 20129
Email: austria@watlow.com
Website: www.watlow.com

Watlow France
Tour d'Asnières.
4 Avenue Laurent Cély
92600 Asnières sur Seine
France
Tél: + 33 (0) 1 41 32 79 70
Télécopie: + 33(0)1 47 33 36 57
Email: info@watlow.fr
Website: www.watlow.com

Watlow GmbH
Postfach 11 65, Lauchwasenstr. 1
D-76709 Kronau
Germany
Tel: +49 (0) 7253 9400-0
Fax: +49 (0) 7253 9400-900
Email: info@watlow.de
Website: www.watlow.com

Watlow Italy S.r.l.
Viale Italia 52/54
20094 Corsico Milano
Italy
Tel: +39 024588841
Fax: +39 0245869954
Email: italyinfo@watlow.com
Website: www.watlow.com

Watlow Ibérica, S.L.U.
C/Marte 12, Posterior, Local 9
E-28850 Torrejón de Ardoz
Madrid - Spain
T. +34 91 675 12 92
F. +34 91 648 73 80
Email: info@watlow.es
Website: www.watlow.com

Watlow Ltd.
Roby Close, Linby Ind. Estate
Linby
NG15 8AA Nottingham
United Kingdom
Email: info@watlow.co.uk
Website: www.watlow.com
From outside The United Kingdom:
Tel: +44 (0) 115 964 0777
Fax: +44 (0) 115 964 0071

Asia and Pacific

Watlow Singapore Pte Ltd.
20 Kian Teck Lane, 4th Floor
Singapore 627854
Tel: +65 6773 9488
Fax: +65 6778 0323
Email: info@watlow.com.sg
Website: www.watlow.com.sg

Watlow Electric Manufacturing Company (Shanghai) Co. Ltd.
Greenland International Plaza Room 1306
275-8 East Guoding Road, Yangpu District
Shanghai 200433
China
Local Phone: 4006 Watlow (4006 928569)
International: +86 21 3381 0188
Fax: +86 21 6106 1423
Email: info-cn@watlow.com
Website: www.watlow.cn

Watlow Thermal Solutions India Pvt., Ltd.
401 Aarohan Plaza, 4th Floor
No. 6-3-678/1 Panjagutta
Hyderabad 500082 Telangana
India
Tel: +91-40-666 12700
Email: infoindia@watlow.com
Website: www.watlow.com

ワトロー ジャパン株式会社
〒101-0047 東京都千代田区内神田1-14-4
四国ビル別館9階
Tel: 03-3518-6630 Fax: 03-3518-6632
Email: infoj@watlow.com Website: www.watlow.co.jp

Watlow Japan Ltd.
Shikoku Building Annex 9th Floor
1-14-4 Uchikanda, Chiyoda-Ku
Tokyo 101-0047
Japan
Tel: +81-3-3518-6630 Fax: +81-3-3518-6632
Email: infoj@watlow.com Website: www.watlow.co.jp

Watlow Korea Co., Ltd.
#2208, Hyundai KIC Building B, 70 Doosan-ro
Geumcheon-gu, Seoul
Republic of Korea
Tel: +82 (2) 2169-2600 Fax: +82 (2) 2169-2601
Website: www.watlow.co.k

瓦特龍電機股份有限公司
80143 高雄市前金區七賢二路189號 10樓之一
電話: 07-2885168 傳真: 07-2885568

Watlow Electric Taiwan Corporation
10F-1 No.189 Chi-Shen 2nd Road Kaohsiung 80143
Taiwan
Tel: +886-7-2885168 Fax: +886-7-2885568
Email: ryeh@watlow.com
Website: www.watlow.com

Your Authorized Watlow Distributor

