

Modular electrical terminal CPX

FESTO

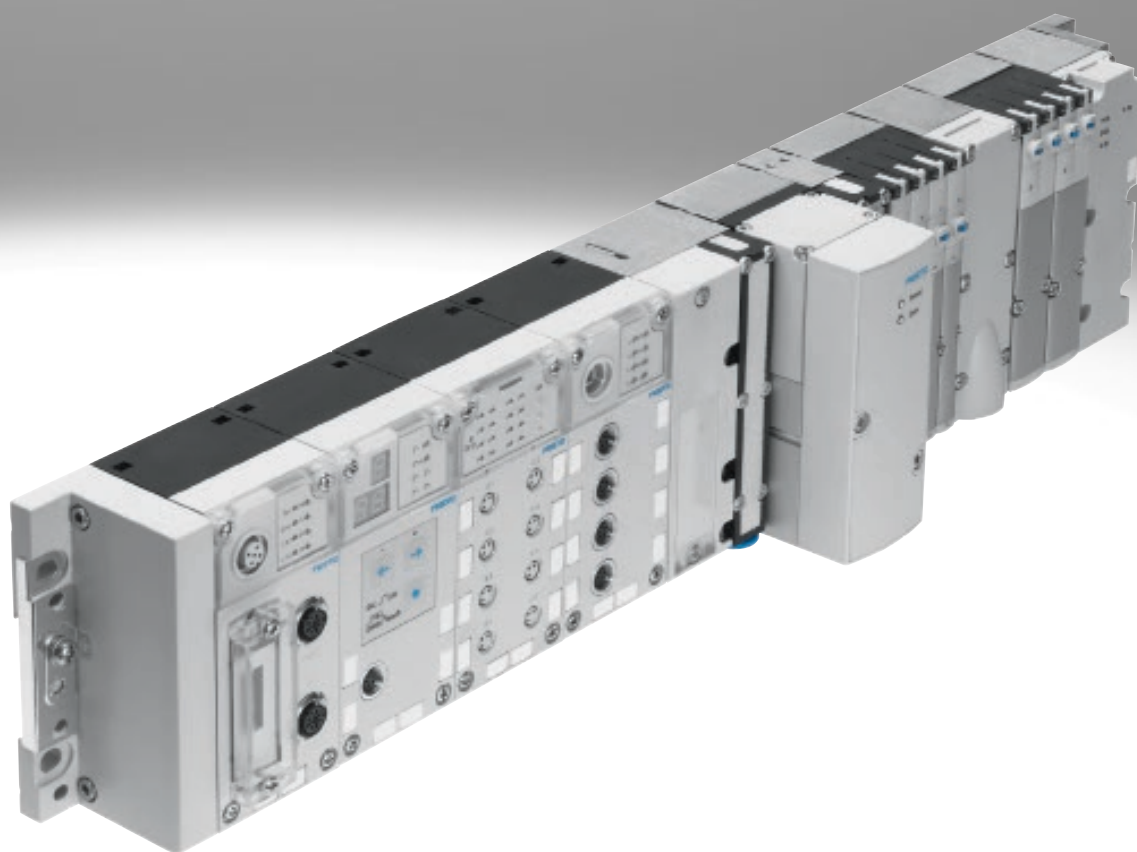

Key features

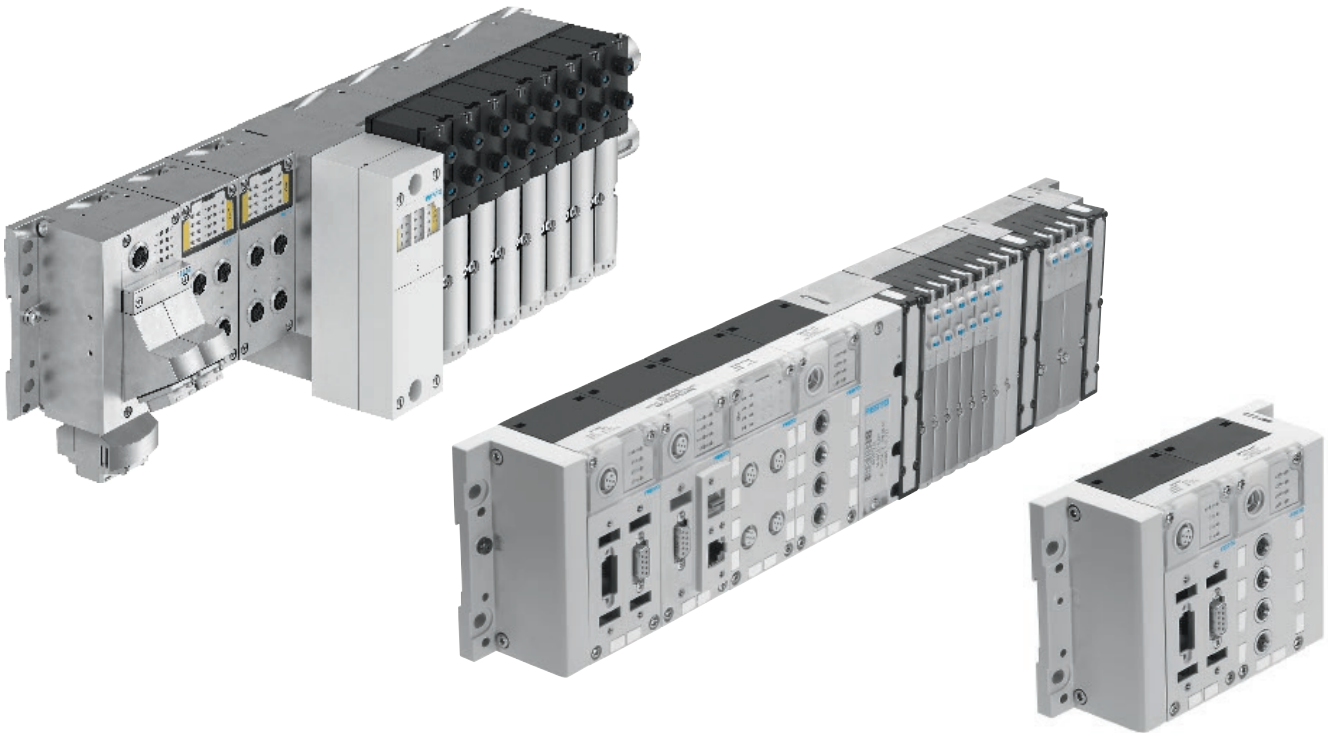

Key features

Installation concept

- Choice of several valve terminals for different applications:
 - MPA-S
 - MPA-L
 - VTSA/VTSA-F/VTSA-F-CB
- Economical from the smallest configuration up to the maximum number of modules
- Up to 9 electrical input/output modules plus bus node and pneumatic interface/electronics modules for valves
- Extensive range of functions and connection options for the electrical modules
- Choice of connection technology for technically and economically optimised connections
- Can be used as a dedicated remote I/O module

Electrics

- High operating voltage tolerance ($\pm 25\%$)
- Choice of M12x1, M18, 7/8" or AIDA push-pull connection for power supply
- Open to all fieldbus protocols and Ethernet
- Optional function and technology modules for preprocessing
- IT services and TCP/IP such as remote maintenance, remote diagnostics, web server, SMS and e-mail alert
- Digital inputs and outputs, 4-/8-/16-way, optionally available with individual channel diagnostics
- Analogue inputs and outputs, 2-way/4-way, optionally with HART protocol
- Pressure inputs
- Temperature inputs
- Controllers for pneumatic and electric axes
- IP65 and IP67 or IP20

Mounting

- Wall or H-rail mounting, also on mobile units
- Conversions/extensions are possible at any time, individual linking with CPX metal design
- Modular system offering a range of configuration options
- Fully assembled and tested unit
- Reduced costs for selection, ordering, assembly and commissioning thanks to the central CPX terminal
- Choice of pneumatic components for optimised control chain
- Decentralised, subordinate CPI installation system improves cycle times by up to 30%
- Safe and convenient earthing thanks to earthing plate

Operation

- Fast troubleshooting thanks to an extensive selection of LEDs (some of which are multi-coloured) on the bus node and on all I/O modules
- Supports module and channel-oriented diagnostics
- Fieldbus/Ethernet remote diagnostics
- Innovative diagnostic support with integrated web server/web monitor or maintenance tool with USB adapter for PC
- Optimised commissioning thanks to parameterisable functions
- Reliable servicing with connection blocks and modules that are quick to replace without changing the wiring

Key features

Pneumatic variants of the CPX terminal

The electrical terminal CPX is a modular peripheral system for valve terminals.

The system is specifically designed so that the valve terminal can be adapted to suit a wide range of different applications.

The modular system design lets you configure the number of valves, inputs and additional outputs to suit the application.

With valve terminal – decentralised

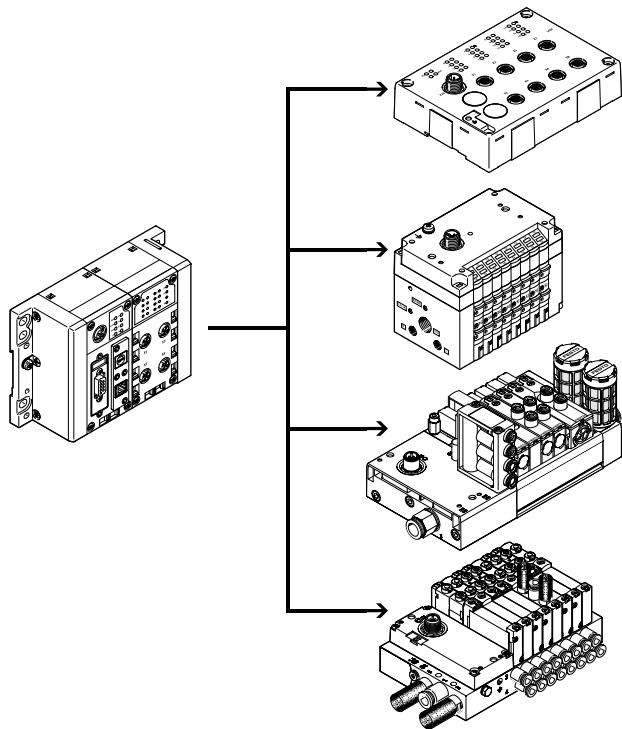

With valve terminal MPA-S – centralised

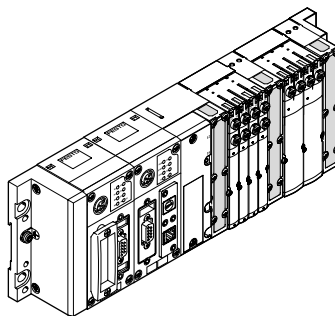

With valve terminal VTSA – centralised

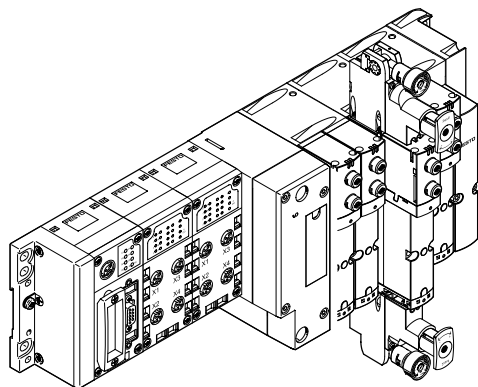

In metal design with valve terminal VTSA – centralised

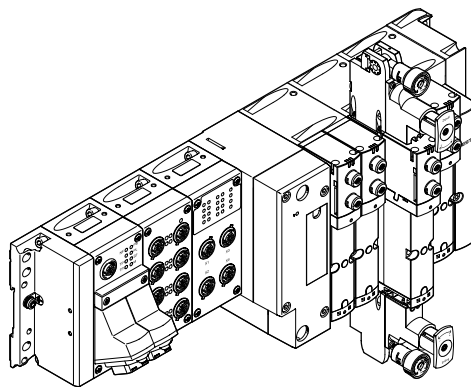

Key features

Variants of the CPX terminal controller (with bus node, without preprocessing)

Bus node

Different bus nodes are used for integration in the control systems of various manufacturers.

The CPX terminal can therefore be operated on over 90% of the most commonly used fieldbus systems:

- PROFIBUS DP
- PROFINET
- DeviceNet
- CANopen
- CC-Link

Integration in universal networks based on Ethernet opens up new possibilities. Faster data transmission, real-time capability and above all additional IT services such as file transfer, web server, web monitor as integrated website in the CPX terminal, text message/e-mail alerts, etc. open up a wide range of synergies.

These include standardised and universal communication technology

across all areas, including operating level, management level and field level in the production environment, with protection to IP65, IP67.

The following protocols are supported:

- EtherNet/IP
- Modbus/TCP
- PROFINET
- POWERLINK
- EtherCAT
- Sercos III

Bus node

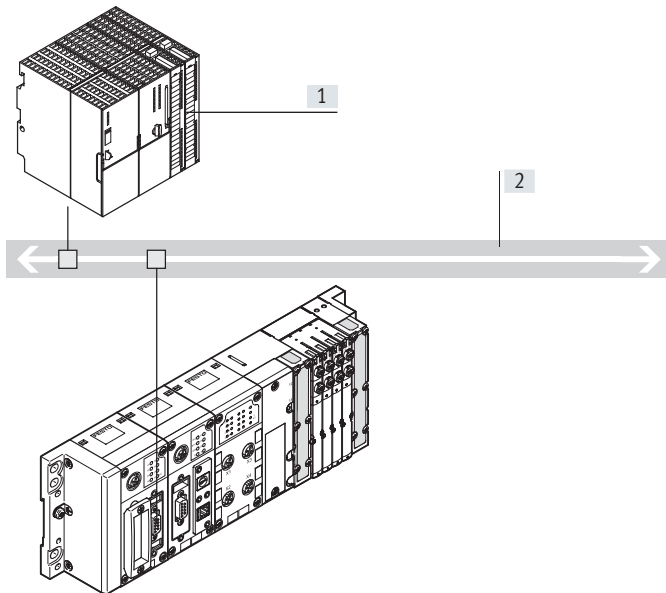

[1] Higher-order controller (PLC)

[2] Fieldbus

- Communication with the higher-order controller via fieldbus
- No preprocessing
- Fieldbus protocol dependent on CPX bus node used
- More than 90 I/Os, depending on bus node used

Industrial Ethernet bus node

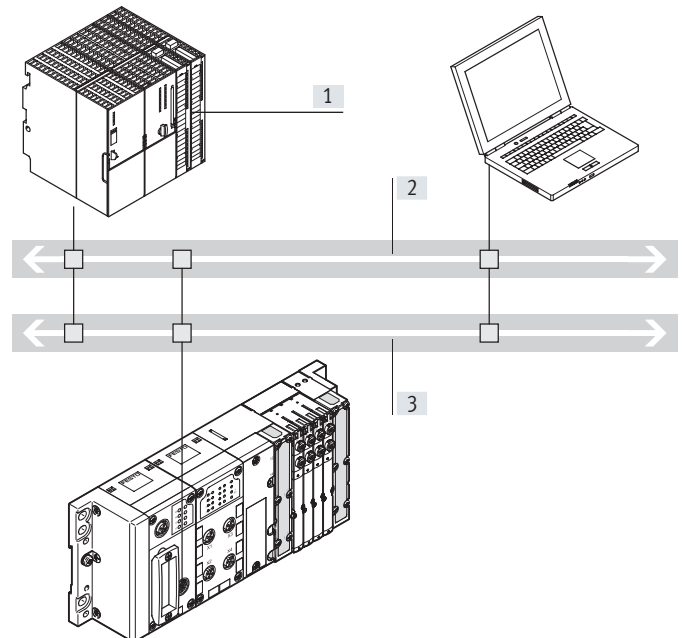

[1] Higher-order controller (PLC)

[2] Fieldbus

[3] IT services:

- Web
- Email
- Data transmission

- Connection to a higher-order controller directly via EtherNet/IP, Modbus/TCP, POWERLINK, EtherCAT or PROFINET
- No preprocessing
- Monitoring via Ethernet and web applications
- More than 300 I/Os

Note

Every electrical interface can be combined with an appropriate number of I/O modules and/or pneumatic components, depending on its address capacity.

Likewise, every pneumatic variant of the CPX terminal can be operated with every electrical interface variant.

Key features

Variants of the CPX terminal controller (with preprocessing in the control block)

Control block

The optional front end controllers CPX-CEC enable simultaneous access via Ethernet, in parallel with a bus node, as well as stand-alone preprocessing.

Access via Modbus/TCP and EasyIP is also possible.

Commissioning, programming, and diagnostics using the Festo software tool FST with hardware configurator.

With control block in stand-alone mode

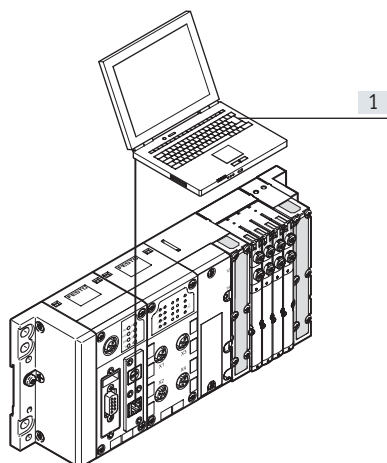

[1] CODESYS/FST

- Decentralised controller with direct machine mounting
- Downloading programs via Ethernet (or via the programming interface)
- Supports full expansion of all CPX peripherals
- More than 300 I/Os

Can be successfully used in the following applications:

- Stand-alone individual workstations
- Interlinked, stand-alone sub-systems
- Automation using IT technology

With control block in Festo EasyIP mode

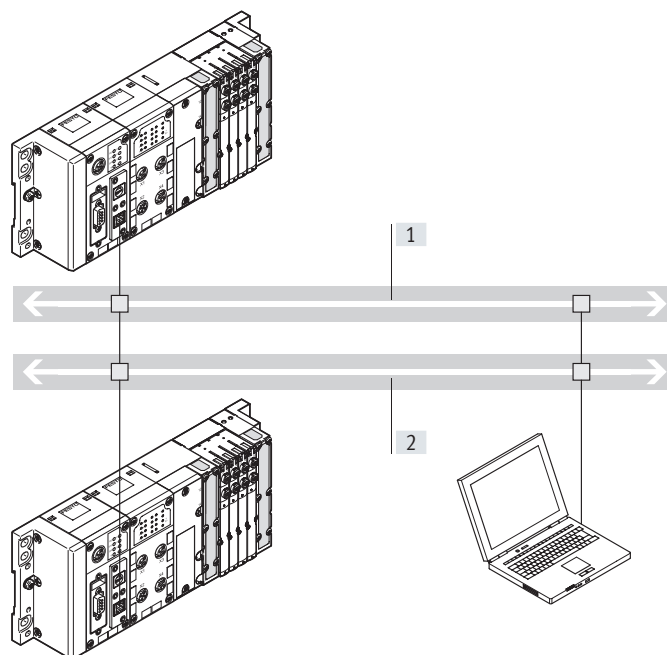

[1] Industrial Ethernet

[2] IT services:

- Web
- Email
- Data transmission

- Fast preprocessing of the CPX peripherals in the control block
- Exchange of any data between the control blocks via EasyIP
- Remote diagnostics
- No higher-order controller is required
- More than 300 I/Os per CPX control block

Key features

Variants of the CPX terminal controller (with preprocessing in the control block)

With control block as remote controller on Ethernet

Remote controller via Ethernet as the preprocessing unit for decentralised, stand-alone sub-systems using IT technology.

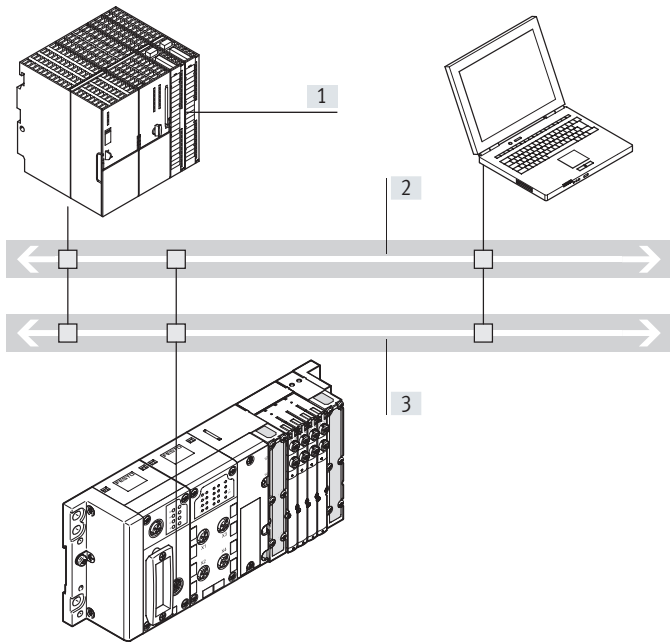

- [1] Higher-order controller (PLC)
- [2] Industrial Ethernet
- [3] IT services:
 - Web
 - Email
 - Data transmission

- Connection to a higher-order controller via Ethernet, no further bus node is required
- Monitoring via Ethernet and web applications
- Preprocessing of the CPX peripherals by CPX control block
- More than 300 I/Os

With control block as remote controller on the fieldbus

Fieldbus remote controller (combination with bus nodes for PROFIBUS DP, PROFINET, CANopen, DeviceNet, CC-Link, POWERLINK, Sercos III or EtherCAT) as the preprocessing unit for decentralised, stand-alone subsystems.

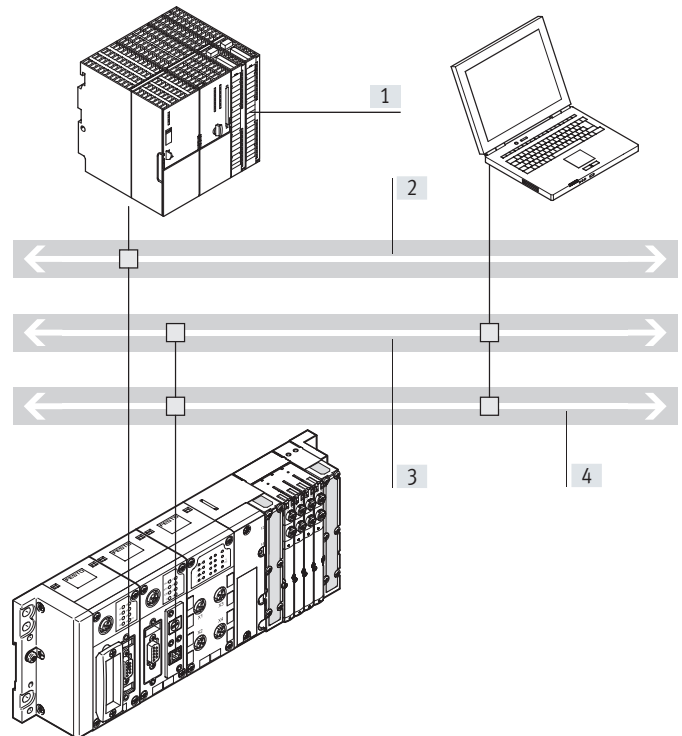

- [1] Higher-order controller (PLC)
- [2] Fieldbus
- [3] Industrial Ethernet
- [4] IT services:
 - Web
 - Email
 - Data transmission

- Fast preprocessing of the CPX peripherals in the control block
- Communication with the higher-order controller via fieldbus
- Optional additional monitoring via Ethernet and web applications
- Downloading programs via programming interface
- More than 300 I/Os, bus node is only used for communication with the higher-order PLC
- Option of two bus nodes for redundant communication configuration

Key features

Variants of the CPX terminal controller (with preprocessing in the control block)

With control block as CANopen fieldbus master

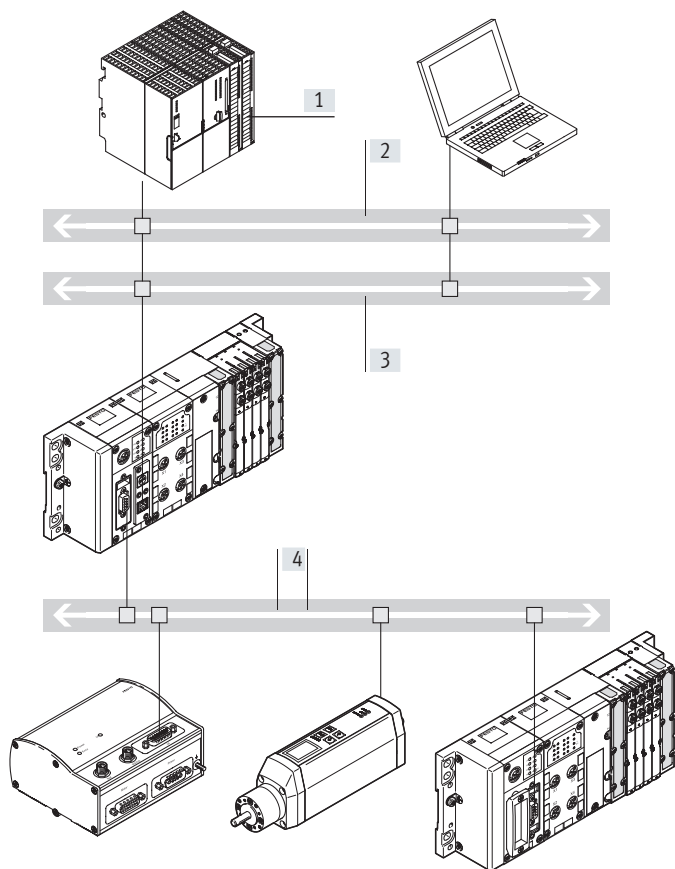

- [1] Higher-order controller (PLC)
- [2] Industrial Ethernet
- [3] IT services:
 - Web
 - Email
 - Data transmission
- [4] Fieldbus (CANopen)

Features:

- Connection to a higher-order controller via Ethernet, no further bus node is required
- Monitoring via Ethernet
- Preprocessing of the CPX peripherals by CPX control block
- More than 300 I/Os
- Up to 128 stations with repeater technology on CANopen

Operating modes:

- Remote controller on Ethernet
- Control block in Festo EasyIP mode

Key features

Connection of inputs and outputs to the CPX terminal

Digital and analogue CPX I/O modules

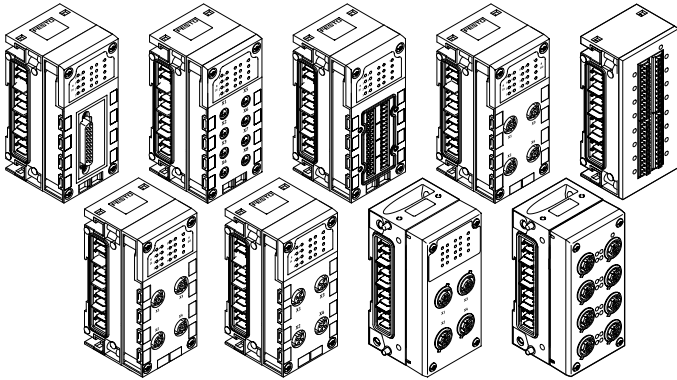

Electrical connection

The connection technology for sensors and additional actuators offers a wide range of digital and analogue input and output modules and is freely selectable – as appropriate to your standard or the application. Plastic or metal connection blocks can be combined as required:

- Metal version
 - M12-5POL
- Plastic version:
 - M12-5POL
 - M12-5-PIN with quick lock and metal thread
 - M12-8POL
 - M8-3POL
 - M8-4POL
 - Sub-D
 - CageClamp® (with cover also to IP65, IP67)
 - Screw/spring-loaded terminal

With CPX-CP interface

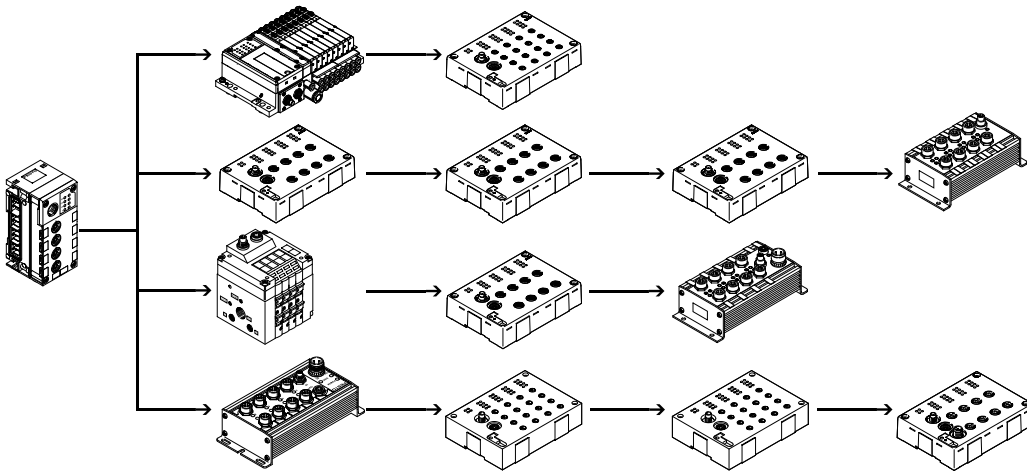

- Up to 4 strings per CP interface possible.
- Up to 4 subordinate CP modules can be combined in one string.
- Up to 32 I/Os can be connected per string.
- Modules with M8, M12
- Several CP interface modules can be combined in one CPX terminal (depending on the controller used).
- Combination of centralised CPX I/O modules and decentrally mounted I/O modules of the installation system CPI.

Combined centralised and decentralised electrical connection (valve terminal with CP interface/output module)

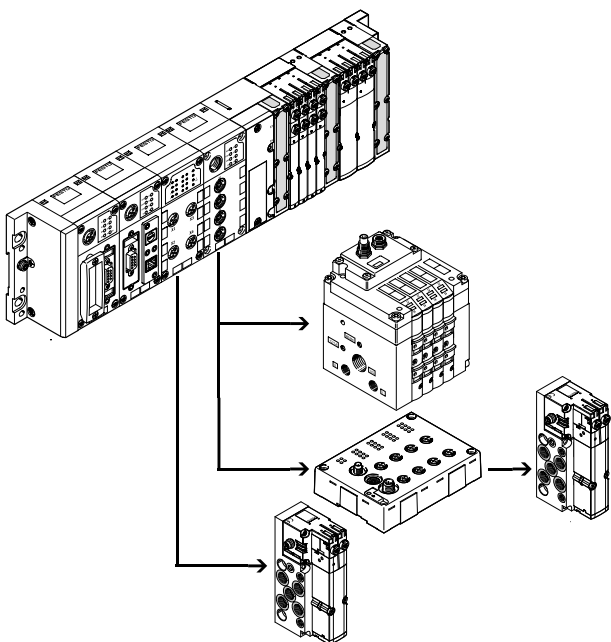

- Scalable to different requirements within a system
- One control interface in the system, reduces installation complexity with closely and widely spaced actuators
- Enables an optimum electrical and pneumatic control chain

Key features

Connection of inputs and outputs to the CPX terminal

With CPX-CTEL interface

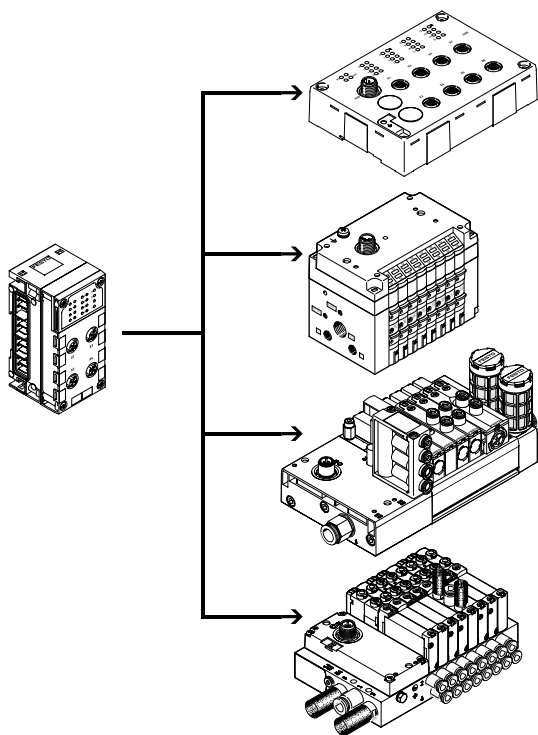

- Up to 4 devices with individual electronic protection per CPX CTEL master
- Max. 64 inputs/64 outputs per I-Port interface
- The maximum length of a string is 20 m.
- Input modules with 16 digital inputs (connection technology M8 3-pin and M12 5-pin)
- Valve terminals with I-Port interface (up to 48 solenoid coils, different valve functions)

Several CPX CTEL masters can be combined on one CPX terminal (depending on the controller used).

Combination of central CPX I/O modules and decentrally mounted I/O modules with I-Port interface.

With CPX-CTEL-2 interface

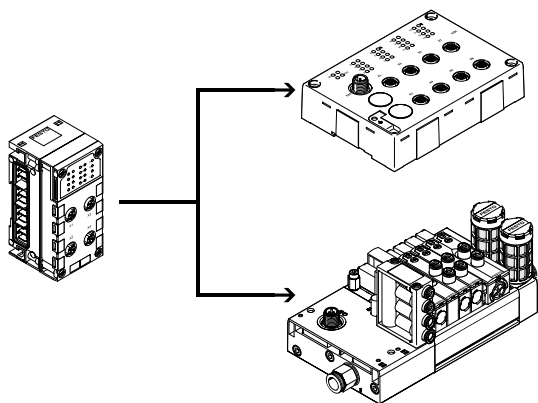

- Up to 2 IO-Link devices with individual electronic protection per CPX-CTEL-2 interface
- Max. 16-byte inputs/16-byte outputs per IO-Link device
- The maximum length of a string is 20 m.

Several CPX-CTEL-2 interfaces can be combined on one CPX terminal (depending on the controller used).

Combination of central CPX I/O modules and decentrally mounted I/O modules with IO-Link interface.

Key features

Connection of inputs and outputs to the CPX terminal

Electric drives with axis interface CPX-CM-HPP

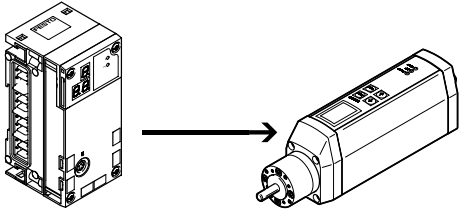

- Max. 4 individual electric axes possible per CPX-CM-HPP
- No programming required
- Standardised communication with the drives via the Festo Handling and Positioning Profile (FHPP)
- The control component is independent of the bus node used

Pneumatic drives with CPX-CMAX/CMPX

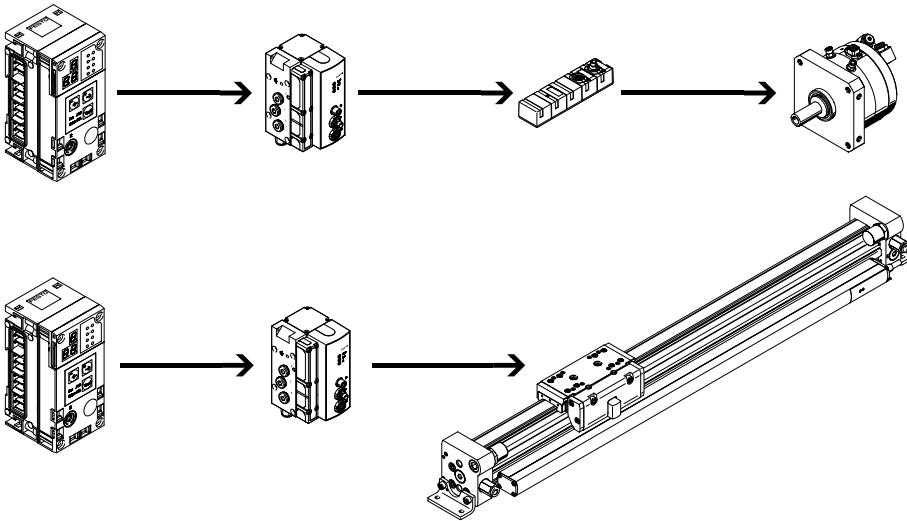

CPX-CMAX

- Position and force control, directly actuated or selected from one of 64 configurable positioning sets
- The configurable record sequencing function enables simple functional sequences to be realised
- Auto identification detects every station with its device data on the controller
- Control of a brake or clamping unit via the proportional directional control valve VPWP
- Up to 7 modules (max. 7 axes) can be operated in parallel and independently of each other
- Commissioning via the Festo configuration software FCT or via fieldbus

CPX-CMPX

- Fast travel between the mechanical end stops of the cylinder, stopping gently and without impact in the end position
- Fast commissioning via control panel, fieldbus or handheld terminal
- Improved downtime control
- Control of a brake or clamping unit via the proportional directional control valve VPWP
- Max. 9 end-position controllers can be actuated depending on the fieldbus
- All system data can be read and written via the fieldbus, including the mid-positions, for example:

Key features

Ordering

The CPX terminal with valve terminal is fully assembled according to your order specifications and individually tested. The finished valve terminal consists of the electrical peripherals including the desired actuation and the selected components of the VTSA (ISO), VTSA-F, VTSA-F-CB, MPA-S or MPA-L modules. The CPX terminal with valve terminal is ordered using two separate order codes.

One order code defines the electrical peripherals type CPX, while the other specifies the pneumatic components of the valve terminal.

The electrical peripherals type CPX can also be configured without a valve terminal and can be used on a fieldbus. To order this, only the order code for the electrical peripherals is required.

The order lists for the pneumatic components can be found at

- Internet: vtsa
(Valve terminal VTSA)
- Internet: vtsa-f
(Valve terminal VTSA-F)
- Internet: vtsa-f-cb
(Valve terminal VTSA-F-CB)
- Internet: mpa-s
(Valve terminal MPA-S)
- Internet: mpa-l
(Valve terminal MPA-L)

The order lists for the CP/CPI components can be found at

- Internet: cpi
(Installation system CPI)

The order lists for the CTEU/CTEL components can be found at

- Internet: cteu
(I-Port interface/IO-Link)

Peripherals overview

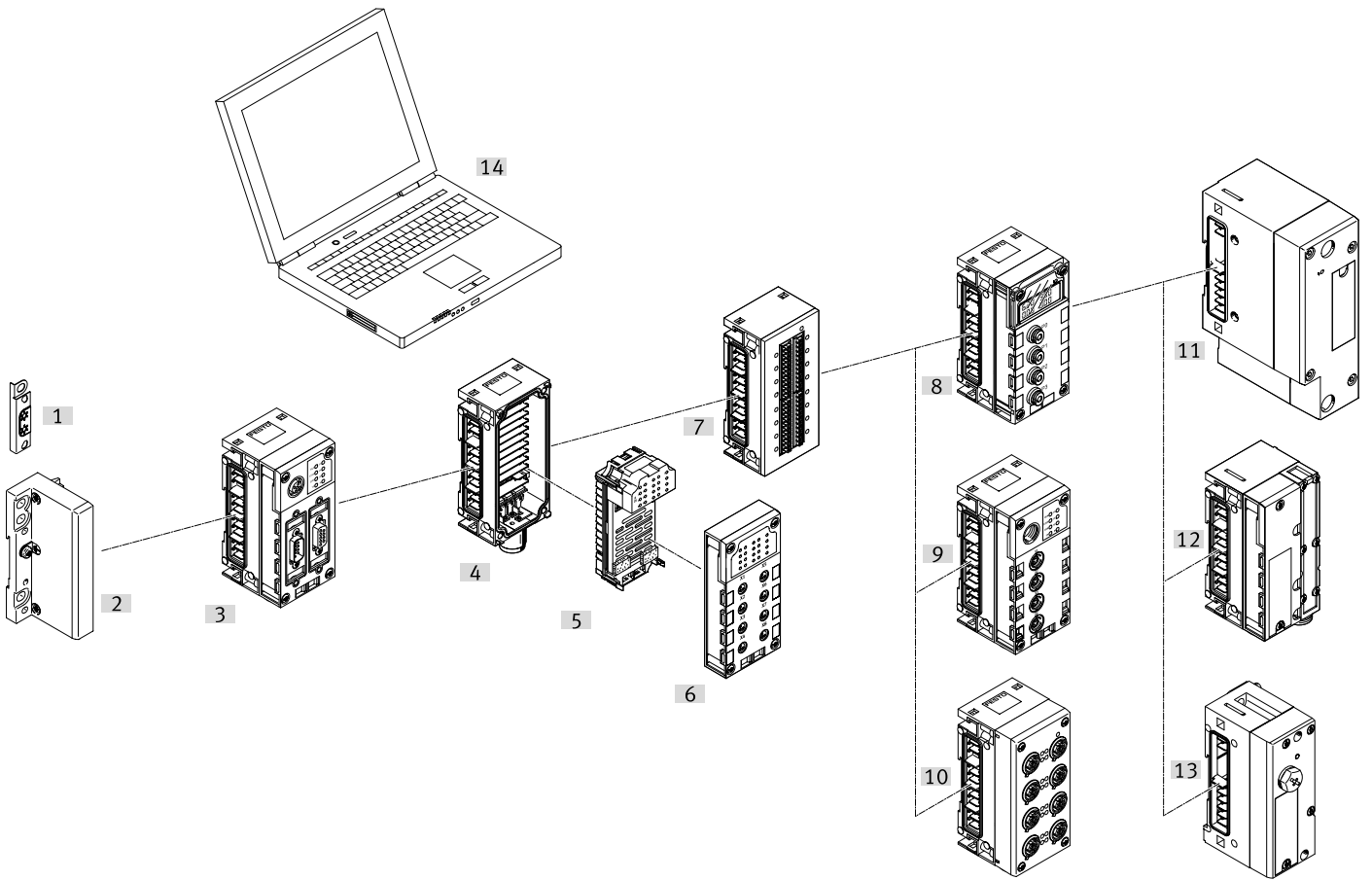

| Designation | Type | Description | → Page/Internet |
|--------------------------------|--------------------|---|-----------------|
| [1] Earthing component | CPX-EPFE-EV | For right/left end plate | 52 |
| [2] End plate | CPX-EP | <ul style="list-style-type: none"> • Mounting holes for wall mounting • Functional earth connection • Special earthing plate for safe and easy connection to the machine bed or H-rail • External power supply for the entire system | 52 |
| [3] Busknoten | CPX-FB CPX-M-FB | <ul style="list-style-type: none"> • Fieldbus/Industrial Ethernet connection using various types of connection technology • Setting fieldbus parameters via DIL switch • Display of fieldbus and peripheral equipment status via LED • PROFINET to AIDA standard in metal housing, fast start-up | 72 |
| Control block | CPX-CEC | <ul style="list-style-type: none"> • Preprocessing, stand-alone controller or remote unit CPX-CEC • Connection via Ethernet TCP/IP or Sub-D programming interface • Setting operating modes via DIL switch and program selection via rotary switch • CPX-CMX products for controlling axes | 65 |
| Gateway | CPX-IOT | <ul style="list-style-type: none"> • Separate CPX combination • Data gathering for connected components • Secure data transfer to a central storage location (MQTT broker) | 58 |
| [4] Plastic interlinking block | CPX-GE | <ul style="list-style-type: none"> • Internal linking of the power supply and serial communication • External power supply for the entire system or for outputs or valves • Connection accessories for M18, 7/8" • Linking with tie rods | 51 |
| Interlinking block, metal | CPX-M-GE | <ul style="list-style-type: none"> • Internal linking of the power supply and serial communication • External power supply for the entire system or for outputs • Transmission of the power supply • Connection accessories for M12x1, 7/8" or AIDA push-pull • Individual linking with M6 screws, individually expandable | 51 |

Peripherals overview

| Designation | Type | Description | → Page/Internet |
|--|--|--|-----------------|
| [5] Electronics module | CPX-4DE | Input module with 4 digital inputs, positive logic (PNP) | 145 |
| | CPX-8DE | Input module with 8 digital inputs, positive logic (PNP) | |
| | CPX-8DE-D | Input module with 8 digital inputs, positive logic (PNP), enhanced diagnostic function | |
| | CPX-8NDE | Input module with 8 digital inputs, negative logic (NPN) | |
| | CPX-P-8DE-N | NAMUR input module with 8 digital inputs | 150 |
| | CPX-F8DE-P | PROFIsafe input module with 8 digital inputs | 154 |
| | CPX-16DE | Input module with 16 digital inputs, internal electronic fuse per module | 160 |
| | CPX-M-16DE-D | Input module with 16 digital inputs, internal electronic fuse per channel pair, for CPX in metal | |
| | CPX-4DA | Output module with 4 digital outputs, 1 A per channel | 166 |
| | CPX-8DA | Output module with 8 digital outputs, 0.5 A per channel | |
| | CPX-8DA-H | Output module with 8 digital outputs, 2.1 A per channel pair | |
| | CPX-8DE-8DA | Input/output module with 8 digital inputs and 8 digital outputs | 172 |
| | CPX-2ZE2DA | Counter module with 2 digital inputs and 2 digital outputs | 177 |
| | CPX-4AE-4AA-H | HART input/output module with 4 analogue input/outputs | 181 |
| | CPX-2AE-U-I | Input module with 2 analogue current and/or voltage inputs | 186 |
| | CPX-4AE-U-I | Input module with 4 analogue current and/or voltage inputs | |
| | CPX-4AE-I | Input module with 4 analogue current inputs | |
| | CPX-4AE-T | Input module for temperature inputs | 193 |
| | CPX-4AE-TC | Input module for temperature inputs with cold junction compensation | 197 |
| | CPX-2AA-U-I | Output module with 2 analogue current or voltage outputs | 201 |
| CPX-FVDA-P2 | PROFIsafe shut-off module for shutting off the supply voltage for valves, with two digital outputs | 205 | |
| [6] Plastic connection block | CPX-AB | <ul style="list-style-type: none"> Choice of 8 connection technology variants Degree of protection IP65, IP67 or IP20 Can be combined with the electronics modules Connection accessories for M8/M12/Sub-D M8/M12/Sub-D, etc. connecting cables Modular system for M8/M12 connecting cables | – |
| [7] Connection block including electronics module and interlinking block | CPX-L | <ul style="list-style-type: none"> Spring-loaded terminal Degree of protection IP20 Digital input module with 16 inputs Digital I/O module with 8 inputs and 8 outputs Plastic connection block | – |
| [8] Analogue electronics module for pressure inputs | CPX-4AE-P | <ul style="list-style-type: none"> Pneumatic connection QS-4 Degree of protection IP 65, IP67 4 analogue pressure inputs (0 ... 10 bar, –1 ... +1 bar) | 191 |
| [9] CP interface CTEL interface | CPX-CP | <ul style="list-style-type: none"> Interfaces for decentralised installation systems, thus optimising the pneumatic control chains (short tubes/short cycle times) Actuation for I/O modules and valve terminals Power supply and bus interface via the same cable M9, M12 connection technology Degree of protection IP 65, IP67 | 117 |
| | CPX-CTEL | | 122 |
| [10] Metal connection block | CPX-M-AB | <ul style="list-style-type: none"> Can be combined with the electronics modules Connection technology M12x1, 5-pin Degree of protection IP 65, IP67 Connection accessories for M12 Connecting cable M12, Modular system for choice of connecting cables M12 | – |
| [11] Pneumatic interface VTSA | VABA-S6 | <ul style="list-style-type: none"> Control of valve terminal VTSA/VTSA-F/VTSA-F-CB Control of pressure sensors | 236 |
| [12] Pneumatic interface MPA-S | VMPA-FB | <ul style="list-style-type: none"> Control of valve terminal MPA-S Control of pressure sensors Control of proportional pressure regulators | 231 |
| [13] Pneumatic interface MPA-L | VMPAL-EPL-CPX | Control of valve terminal MPA-L | 234 |
| [14] Web monitor | – | <ul style="list-style-type: none"> Website integrated in the CPX terminal Dynamic status indication Online diagnostics and SMS/e-mail alert | – |

Peripherals overview

Individual overview of modules

Bus node

→ Page 72

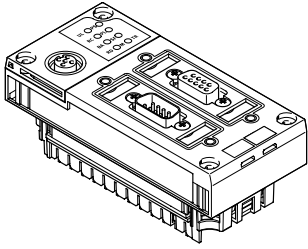

Bus node for

- PROFIBUS DP
 - DeviceNet
 - CANopen
 - CC-Link
 - EtherNet/IP
- PROFINET
 - POWERLINK
 - EtherCAT
 - Sercos III

Control block

→ Page 65

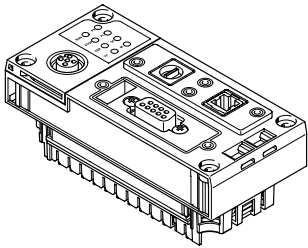

CPX-CEC

- Programming with CODESYS
- Ethernet interface
- Modbus/TCP
- EasyIP
- CANopen master

Gateway

→ Page 58

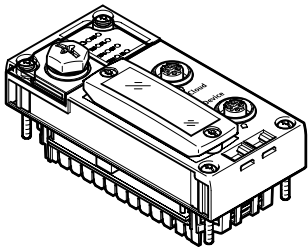

CPX-IOT

- Continuous transfer of operating data from connected Festo components to a central storage location (user-specific MQTT broker)
- Ethernet interface

CP interface

→ Page 117

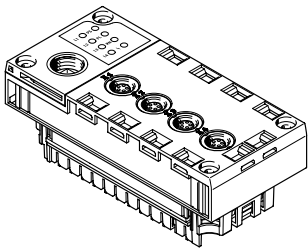

Interface CPX-CP

- 4 CP strings
- Max. 4 modules per string
- 32 inputs/32 outputs per string
- CPI functionality

CTEL interface

→ Page 122

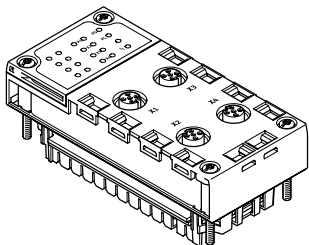

CPX-CTEL interface

- CTEL master
- Max. 4 devices with individual electronic protection
- Max. 64 inputs/64 outputs per I-Port interface
- The maximum length of a string is 20 m

Electrical interface CPX-CTEL-2

→ Page 128

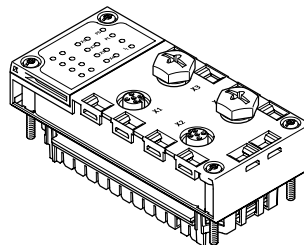

CPX-CTEL-2 interface

- Master for IO-Link
- Max. 2 devices with individual electronic protection
- Process data length of the inputs and outputs is limited to 16 bytes for inputs and 16 bytes for outputs per port
- The maximum length of a string is 20 m

Peripherals overview

Individual overview of modules

Modules for actuating electric drive units

→ Page 133

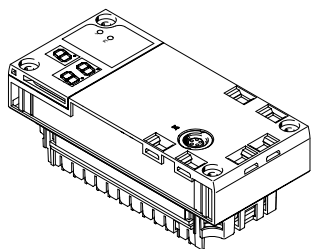

CPX-CM-HPP

- Axis interface
- CAN bus for up to 4 individual electric axes

Modules for controlling pneumatic drive units

→ Page 136

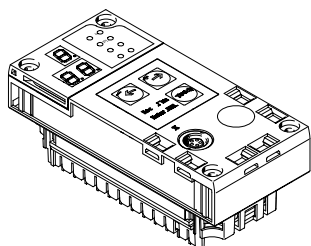

CPX-CMAX

- Axis controller
- Position and force control
- 64 configurable positioning records
- Auto-identification
- Control of a brake or clamping unit via the proportional directional control valve VPWP

CPX-CMPX

- End-position controller
- Fast travel between the mechanical end stops of the cylinder
- Smooth travel into the end position
- Improved downtime control
- Control of a brake via the proportional directional control valve VPWP

CPX-CMIX

- Measuring module
- CAN input (Festo specification) for measuring signal
- Recording the absolute position values or speed values of the connected drive

Plastic connection block

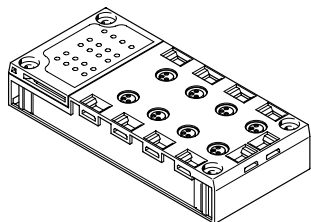

Direct machine mounting (degree of protection IP65, IP67)

- M8-3POL
- M8-4POL
- M12-5POL
- M12-5POL quick lock, shielded with metal thread
- M12-8POL
- Sub-D
- Spring-loaded terminal with cover

Protected fitting space (degree of protection IP20)

- Spring-loaded terminal

Shielding concept

- Optional screening plate for connection blocks with M12 connection technology

Metal connection block

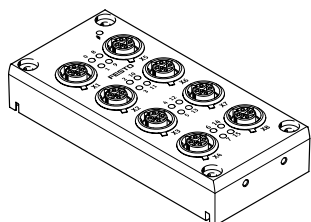

Direct machine mounting (degree of protection IP65, IP67)

- M12-5POL

Connection block including electronics module and interlinking block

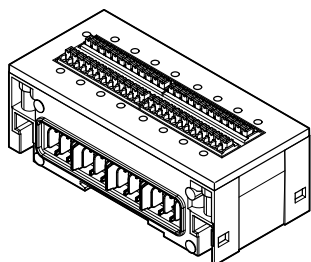

Installation in the control cabinet (degree of protection IP20)

- Plastic connection block
- Spring-loaded terminal
- Digital input module with 16 inputs
- Digital I/O module with 8 inputs and 8 outputs

Peripherals overview

Individual overview of modules

Connection block for NAMUR sensors and HART input/output module

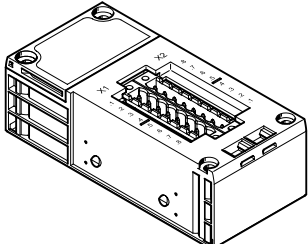

Direct machine mounting
(connection block to IP65)

- M12-4POL

Protected fitting space
(connection block to IP20)

- Screw terminal
- Spring-loaded terminal

Digital electronics module for inputs/outputs

→ Page 145

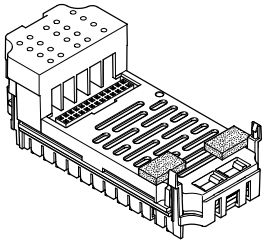

Digital inputs

- 4 digital inputs
- 8 digital inputs NPN
- 8 digital inputs PNP
- 8 digital inputs PNP with individual channel diagnostics
- 16 digital inputs
- 16 digital inputs with individual channel diagnostics

Digital outputs

- 4 digital outputs (1 A per channel, individual channel diagnostics)
- 8 digital outputs (0.5 A per channel, individual channel diagnostics)
- 8 digital outputs (2.1 A/50 W lamp load per channel pair, individual channel diagnostics)

Multi I/O modules

- 8 digital inputs and 8 digital outputs
- 2 digital inputs (counter channels, connection to various encoders) and 2 digital outputs (directly controlled by the input values)

Digital electronics module for NAMUR sensors

→ Page 150

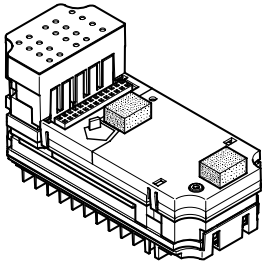

Digital inputs

- 8 digital inputs for NAMUR sensors or wired mechanical contacts

Analogue electronics module for inputs/outputs

→ Page 186

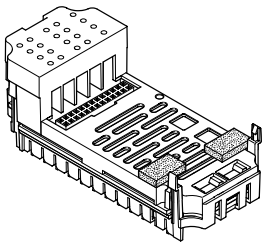

Analogue inputs

- 2 analogue inputs (0 ... 10 V DC, 0 ... 20 mA, 4 ... 20 mA)
- 4 analogue inputs (1 ... 5 V, 0 ... 10 V, -5 ... +5 V, -10 ... +10 V, 0 ... 20 mA, 4 ... 20 mA, -20 ... +20 mA)
- 4 analogue inputs with HART protocol

Analogue temperature inputs

- 4 analogue inputs for temperature measurement (Pt100, Pt200, Pt500, Pt1000, Ni100, Ni120, Ni500, Ni1000)
- 4 analogue inputs for temperature measurement (thermocouple and PT1000 sensor for cold-junction compensation)

Analogue outputs

- 2 analogue outputs (0 ... 10 V DC, 0 ... 20 mA, 4 ... 20 mA)
- 4 analogue outputs with HART protocol

PROFIsafe input module

→ Page 154

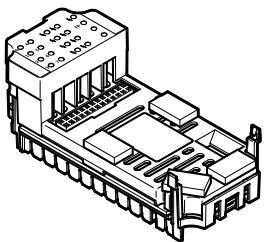

Digital inputs

- 8 digital inputs
- 11 function modes
- 5 independent clock outputs

PROFIsafe shut-off module

→ Page 205

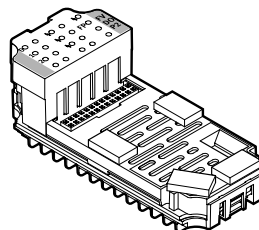

Digital outputs

- 2 digital outputs
- Supply voltage for valves can be shut off

Peripherals overview

Individual overview of modules

Analogue electronics module for pressure inputs

→ Page 191

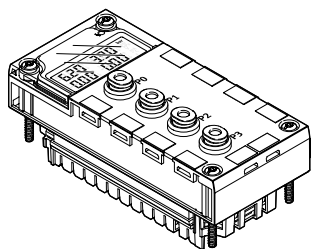

Analogue inputs

- 4 analogue pressure inputs (0 ... 10 bar, -1 ... +1 bar)

Plastic interlinking block – Interlinking using tie rods

→ Page 214

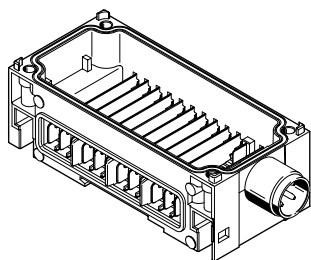

System linking

- Different voltages for supplying the modules
- Serial communication between the modules

System supply

- M18, 4-pin
- 7/8" 4-pin or 5-pin

In addition to system linking, power supply for the

- Electronics plus sensors (16 A)
- Valves plus actuators (16 A)

Additional supply

In addition to system linking, power supply for the

- Actuators (16 A per supply)

Power supply for the

- Valves (16 A per supply)

Expandability

- Can be expanded using an interlinking block with tie rod CPX-ZA-1-E

Metal interlinking block – Individual linking

→ Page 215

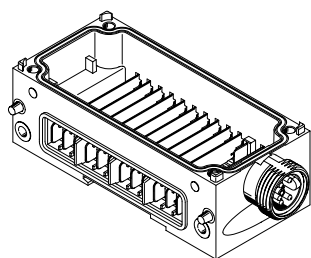

System linking

- Different voltages for supplying the modules
- Serial communication between the modules

System supply

- 7/8" 4-pin or 5-pin
- M12x1, L-coded, 5-pin
- AIDA push-pull

In addition to system linking, power supply for the

- Electronics plus sensors (16 A)
- Valves plus actuators (16 A)

Additional supply

In addition to system linking, power supply for the

- Actuators (16 A per supply)

Power supply for the

- Valves (16 A per supply)

System forwarding

In addition to system linking, transmission of power supply from the

- Electronics plus sensors (16 A)
- Valves plus actuators (16 A)

to a further CPX terminal or another consuming device.

Expandability

- Can be expanded as required by up to 10 interlinking blocks

-  - Note

Plastic interlinking blocks (tie rods) and metal interlinking blocks (individual linked) cannot be combined due to their different interlinking systems.

-  - Note

The 7/8" supply is subject to the following restrictions due to the available accessories:

- 5-pin 8 A
- 4-pin 10 A

-  - Note

Appropriate interlinking blocks (CPX-...-VL) must be used in ATEX environments as per the certification (→ page 49). The maximum supply is limited to 8 A for these modules.

Peripherals overview

Individual overview of modules

Pneumatic interface MPA-S

→ Page 231

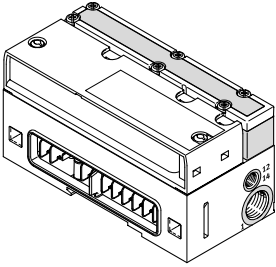

Valve terminal

- MPA1 (360 l/min)
- MPA14 (550 l/min)
- MPA2 (700 l/min)
- Up to 128 solenoid coils
- Up to 16 modules can be configured
- For CPX plastic design
- For CPX metal design
- Actuation of pressure sensors
- Proportional pressure regulators
- Pressure sensors
- Proportional pressure regulators

Pneumatic interface MPA-L

→ Page 234

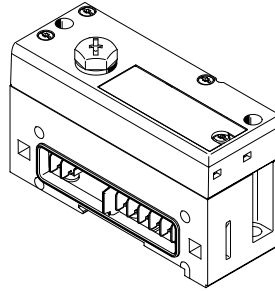

Valve terminal

- MPA1 (360 l/min)
- MPA14 (670 l/min)
- MPA2 (870 l/min)
- Up to 32 solenoid coils
- For CPX plastic design

Pneumatic interface VTSA/VTSA-F

→ Page 236

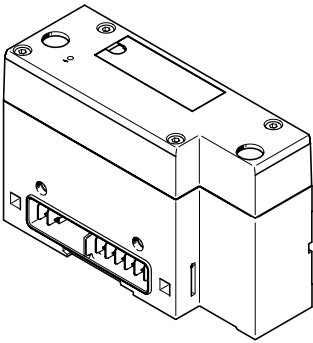

Valve terminal (valve flow rate according to width)

- 18 mm (700 l/min)
- 26 mm (1350 l/min)
- 42 mm (1300 l/min)
- 52 mm (2900 l/min)
- 65 mm (4000 l/min)
- Max. 32 valve positions/max. 32 solenoid coils
- For CPX plastic design
- For CPX metal design

Pneumatic interface VTSA-F-CB

→ Page 238

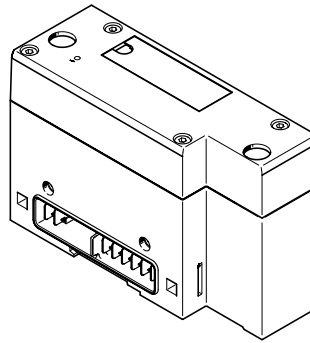

Valve terminal (valve flow rate according to width)

- 18 mm (700 l/min)
- 26 mm (1350 l/min)
- 42 mm (1300 l/min)
- 52 mm (2900 l/min)
- Max. 24 valve positions/max. 24 solenoid coils
- For CPX plastic design
- For CPX metal design

Pneumatic interface VTSA-F-CB

→ Page 238

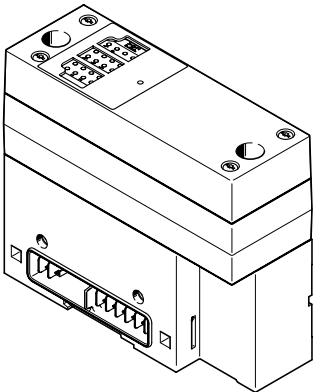

Valve terminal (valve flow rate according to width)

- 18 mm (700 l/min)
- 26 mm (1350 l/min)
- 42 mm (1300 l/min)
- 52 mm (2900 l/min)
- Max. 24 valve positions/max. 24 solenoid coils
- For CPX metal design
- With 3 voltage zones within the valve terminal that can be securely shut down via fieldbus
- With 2 voltage zones within the valve terminal that can be securely shut down via fieldbus and one power supply for external consuming devices that can be securely shut down via fieldbus

Pneumatic interface VTSA-F-CB

→ Page 238

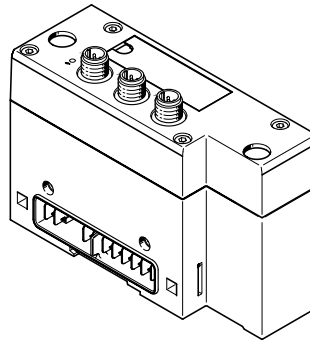

Valve terminal (valve flow rate according to width)

- 18 mm (700 l/min)
- 26 mm (1350 l/min)
- 42 mm (1300 l/min)
- 52 mm (2900 l/min)
- Max. 24 valve positions/max. 24 solenoid coils
- For CPX plastic design
- For CPX metal design
- 3 external voltage supplies for voltage zones within the valve terminal that can be shut down individually

Peripherals overview

Individual overview of modules

End plate for plastic/metal design

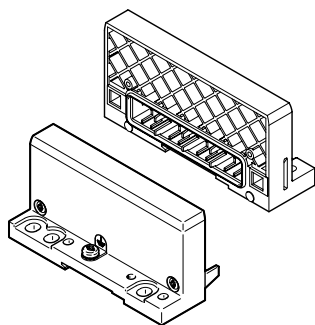

End plate

- Left-hand
- Right-hand (for using the CPX terminal without valves)

End plate with system supply

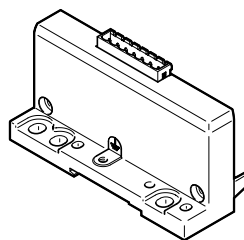

End plate

- Left-hand
- For plastic design
- Different voltages for supplying the CPX terminal

→ Page 210

End plate with extension

→ Page 212

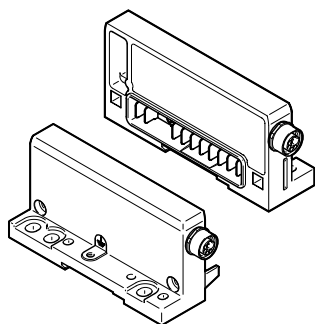

End plate

- Left-hand
- Right-hand
- Enables the CPX terminal to be separated into two interconnected units (series)
- Simplifies control cabinet installation
- For plastic or metal design

Earthing plate (for end plate for plastic design)

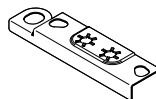

Earthing plate

- For safe and easy connection to the machine bed or H-rail, suitable for right-hand and left-hand end plate
- Assembly and earthing in a single processing step, which means:
 - 50% time saving
 - No additional material required

General basic data and guidelines

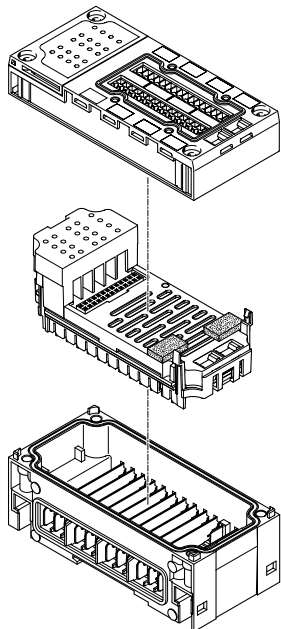

Max. 11 modules in total:

- One bus node and/or one control block, freely positionable
- Up to 9 additional input/output modules, freely positionable
- An additional pneumatic interface always positioned as the last module on the right-hand side
 - For VTSA, VTSA-F: Fixed operating range, set using DIL switch
 - For VTSA-F-CB: Fixed operating range
 - For MPA-S: 16 MPA modules can be configured
 - For MPA-L: Fixed operating range, set using rotary switch
- Address capacity max. 512 inputs and 512 outputs, depending on bus node or control block
- One interlinking block with system supply
- Multiple interlinking blocks with additional supplies
 - Always positioned to the right of the interlinking block with system supply
- With just a few exceptions, the connection blocks can be freely combined with the electronics modules for inputs/outputs, either in metal or plastic design (→ table below)
- The electronics modules for inputs/outputs can be combined with various interlinking blocks

- Plastic interlinking blocks (tie rods) and metal interlinking blocks (individual linked) cannot be combined due to their different interlinking systems.

Peripherals overview

| Combinations of connection blocks and digital input modules | | | | | | |
|---|-----------------------------|---------|-----------|----------|-------------|------------|
| | Digital electronics modules | | | | | |
| | CPX-4DE | CPX-8DE | CPX-8DE-D | CPX-8NDE | CPX-P-8DE-N | CPX-F8DE-P |
| Connection blocks, plastic design | | | | | | |
| CPX-AB-8-M8-3POL | ■ | ■ | ■ | ■ | - | - |
| CPX-AB-8-M8X2-4POL | - | - | - | - | - | - |
| CPX-P-AB-4XM12-4POL | - | - | - | - | ■ | - |
| CPX-AB-4-M12x2-5POL | ■ | ■ | ■ | ■ | - | - |
| CPX-AB-4-M12x2-5POL-R | ■ | ■ | ■ | ■ | - | - |
| CPX-AB-8-M12X2-5POL | - | - | - | - | - | - |
| CPX-AB-4-M12-8POL | - | - | - | - | - | - |
| CPX-AB-8-KL-4POL | ■ | ■ | ■ | ■ | - | ■ |
| CPX-P-AB-2XKL-8POL | - | - | - | - | ■ | - |
| CPX-AB-1-SUB-BU-25POL | ■ | ■ | ■ | ■ | - | - |
| CPX-AB-ID-P | - | - | - | - | - | ■ |
| Connection blocks, metal design | | | | | | |
| CPX-M-AB-4-M12X2-5POL | ■ | ■ | ■ | ■ | - | ■ |
| CPX-M-AB-4-M12X2-5POL-T | - | - | - | - | - | ■ |
| CPX-M-AB-8-M12X2-5POL | - | - | - | - | - | - |

| Combinations of connection blocks and digital input modules | | | |
|---|-----------------------------|------------|--------------|
| | Digital electronics modules | | |
| | CPX-16DE | CPX-L-16DE | CPX-M-16DE-D |
| Connection blocks, plastic design | | | |
| CPX-AB-8-M8-3POL | - | - | - |
| CPX-AB-8-M8X2-4POL | ■ | - | - |
| CPX-P-AB-4XM12-4POL | - | - | - |
| CPX-AB-4-M12x2-5POL | - | - | - |
| CPX-AB-4-M12x2-5POL-R | - | - | - |
| CPX-AB-8-M12X2-5POL | - | - | ■ |
| CPX-AB-4-M12-8POL | - | - | - |
| CPX-AB-8-KL-4POL | ■ | - | - |
| CPX-P-AB-2XKL-8POL | - | - | - |
| CPX-AB-1-SUB-BU-25POL | ■ | - | - |
| CPX-AB-ID-P | - | - | - |
| Connection blocks, metal design | | | |
| CPX-M-AB-4-M12X2-5POL | - | - | - |
| CPX-M-AB-4-M12X2-5POL-T | - | - | - |
| CPX-M-AB-8-M12X2-5POL | - | - | ■ |

Peripherals overview

| Combinations of connection blocks and digital output modules or multi I/O modules | | | | | | | | |
|--|------------------------------|-------------|-------------|-------------|---------------|------------|-------------|------------|
| | Digital electronics modules | | | | | | | |
| | CPX-4DA | CPX-8DA | CPX-8DA-H | CPX-8DE-8DA | CPX-L-8DE-8DA | CPX-2ZE2DA | CPX-FVDA-P2 | |
| Connection blocks, plastic design | | | | | | | | |
| CPX-AB-8-M8-3POL | ■ | ■ | - | - | - | - | - | |
| CPX-AB-8-M8X2-4POL | ■ | ■ | ■ | - | - | - | - | |
| CPX-P-AB-4XM12-4POL | - | - | - | - | - | - | - | |
| CPX-AB-4-M12x2-5POL | ■ | ■ | - | - | - | - | - | |
| CPX-AB-4-M12x2-5POL-R | ■ | ■ | ■ | - | - | - | - | |
| CPX-AB-8-M12X2-5POL | - | - | - | - | - | - | - | |
| CPX-AB-4-M12-8POL | - | - | - | ■ | - | - | - | |
| CPX-AB-8-KL-4POL | ■ | ■ | ■ | ■ | - | - | ■ | |
| CPX-P-AB-2XKL-8POL | - | - | - | - | - | - | - | |
| CPX-AB-1-SUB-BU-25POL | ■ | ■ | ■ | ■ | - | - | - | |
| CPX-AB-ID-P | - | - | - | - | - | - | - | |
| Connection blocks, metal design | | | | | | | | |
| CPX-M-AB-4-M12X2-5POL | ■ | ■ | ■ | - | - | - | ■ | |
| CPX-M-AB-4-M12X2-5POL-T | - | - | - | - | - | - | - | |
| CPX-M-AB-8-M12X2-5POL | - | - | - | - | - | - | - | |
| Combinations of connection blocks and analogue electronics modules for inputs/outputs | | | | | | | | |
| | Analogue electronics modules | | | | | | | |
| | CPX-4AE-4AA-H | CPX-2AE-U-I | CPX-4AE-U-I | CPX-4AE-I | CPX-2AA-U-I | CPX-4AE-P | CPX-4AE-T | CPX-4AE-TC |
| Connection blocks, plastic design | | | | | | | | |
| CPX-AB-8-M8-3POL | - | - | - | - | - | - | - | - |
| CPX-AB-8-M8X2-4POL | - | - | - | - | - | - | - | - |
| CPX-P-AB-4XM12-4POL | ■ | - | - | - | - | - | - | - |
| CPX-AB-4-M12x2-5POL | - | ■ | ■ | ■ | ■ | - | ■ | ■ |
| CPX-AB-4-M12x2-5POL-R | - | ■ | ■ | ■ | ■ | - | ■ | ■ |
| CPX-AB-8-M12X2-5POL | - | - | - | - | - | - | - | - |
| CPX-AB-4-M12-8POL | - | - | - | - | - | - | - | - |
| CPX-AB-8-KL-4POL | - | ■ | ■ | ■ | ■ | - | ■ | ■ |
| CPX-P-AB-2XKL-8POL | ■ | - | - | - | - | - | - | - |
| CPX-AB-1-SUB-BU-25POL | - | ■ | ■ | ■ | ■ | - | - | - |
| CPX-AB-ID-P | - | - | - | - | - | - | - | - |
| Connection blocks, metal design | | | | | | | | |
| CPX-M-AB-4-M12X2-5POL | - | ■ | ■ | ■ | ■ | - | ■ | ■ |
| CPX-M-AB-4-M12X2-5POL-T | - | - | - | - | - | - | - | - |
| CPX-M-AB-8-M12X2-5POL | - | - | - | - | - | - | - | - |

Key features – Electrical components

Electrical connection – Connection block

CPX-AB-8-M8-3POL with connection socket M8, 3-pin

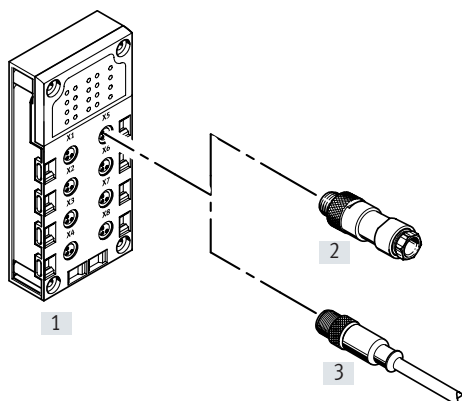

- Compact for pre-assembled individual connection
- 8 sockets
- 3-pin design for connecting one channel per socket

Note
Festo delivers pre-assembled M8/M12 connecting cables (NEBU modular system) on request:

- Tailored to the application
- Perfectly fitting
- Easy to install

Combination of connection block and electrical connection technology

| Connection block | Connection technology | Plug/connecting cable | Connection technology |
|----------------------|-----------------------|---|-----------------------|
| [1] CPX-AB-8-M8-3POL | Socket M8, 3-pin | [2] SEA-GS-M8 | Solder lugs |
| | | [2] SEA-3GS-M8-S | Screw terminals |
| | | [3] NEBU-...-M8G3 (modular system for choice of connecting cables) | Socket, M8, 3-pin |
| | | | Socket, M8, 4-pin |
| | | | Socket, M12, 5-pin |
| | | Open cable end | |

Key features – Electrical components

Electrical connection – Connection block

CPX-AB-8-M8X2-4POL with connection socket M8, 4-pin

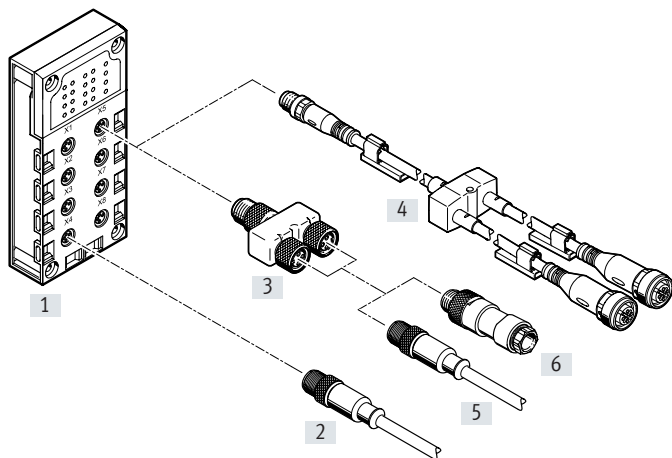

- Compact for pre-assembled individual connection
- 8 sockets
- 4-pin design for connection of 2 channels per socket

Combination of connection block and electrical connection technology

| Connection block | Connection technology | Plug/connecting cable | Connection technology | Plug/connecting cable | Connection technology |
|------------------------|-----------------------|--|--|--|-----------------------|
| [1] CPX-AB-8-M8X2-4POL | Socket, M8, 4-pin | [2] NEBU-...-M8G4 (modular system for choice of connecting cables) | Socket, M8, 3-pin | - | - |
| | | | Socket M8, 4-pin | - | - |
| | | | Socket, M12, 5-pin | - | - |
| | | | Open cable end | - | - |
| | | [3] NEDY-L2R1-V1-M8G3-N-M8G4 (T-adapter) | 1x plug M8, 4-pin to 2x socket, M8, 3-pin | [6] SEA-GS-M8 | Solder lugs |
| | | | | [6] SEA-3GS-M8-S | Screw terminals |
| | | [4]NEDY-... (modular system for all types of sensor/ actuator distributor) | 2x socket, M8, 3-pin 2x socket, M8, 4-pin 2x socket, M12, 5-pin 2x socket, type A 2x socket, type B 2x socket, type C 2x socket, plug pattern H 2x socket, plug pattern ZB 2x socket, plug pattern ZC 2x open cable end | [5] NEBU-...-M8G3 (modular system for choice of connecting cables) | Socket, M8, 3-pin |
| | | | | | Socket, M8, 4-pin |
| | | | | | Socket, M12, 5-pin |
| | | | | | Open cable end |
| | | | | - | - |
| | | | | - | - |
| | | | | - | - |
| | | | | - | - |

Key features – Electrical components

Electrical connection – Connection block

CPX-AB-4-M12x2-5POL and CPX-AB-4-M12x2-5PPOL-R with connection socket M12, 5-pin

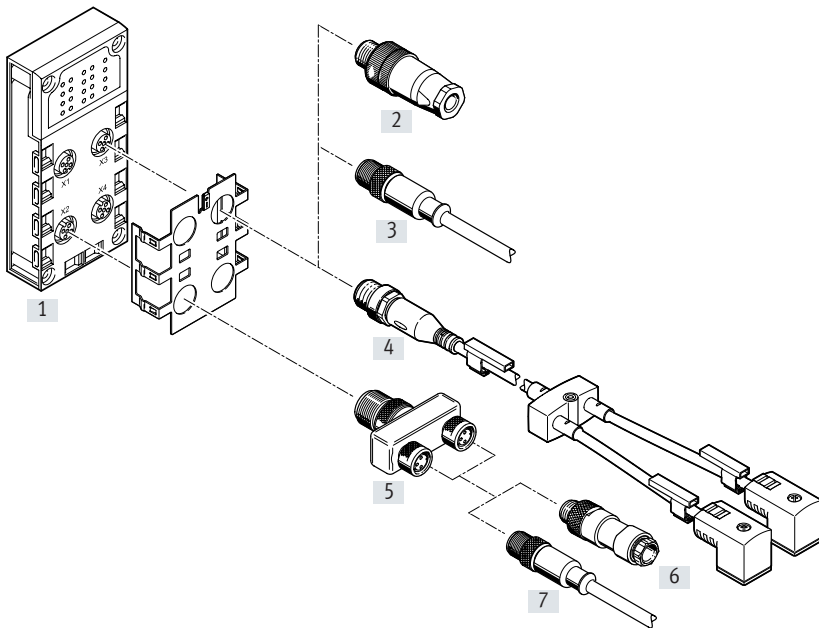

- Suitable for self-assembly and sturdy with 2 channels per connection
- 4 sockets
- 5-pin design per connection
- Version ...-R with quick lock technology and metal thread for shielding
- With two channels per connection, the corresponding input signals can be easily connected via a T-adapter and conventional cables with M8 connection.

Key features – Electrical components

| Combination of connection block and electrical connection technology | | | | | |
|--|-----------------------|---|--|--|--|
| Connection block | Connection technology | Plug/connecting cable | Connection technology | Plug/connecting cable | Connection technology |
| [1] CPX-AB-4-M12x2-5POL CPX-AB-4-M12x2-5POL-R | Socket, M12, 5-pin | [2] SEA-GS-7 | Screw terminals | – | – |
| | | [2] SEA-4GS-7-2.5 | Screw terminals | – | – |
| | | [2] SEA-GS-9 | Screw terminals | – | – |
| | | [2] SEA-M12-5GS-PG7 | Screw terminals | – | – |
| | | [2] SEA-GS-11-DUO | Screw terminals, for two cables | – | – |
| | | [2] SEA-5GS-11-DUO | Screw terminals, for two cables | – | – |
| | | [3] NEBU-...-M12G5 (modular system for choice of connecting cables) | Socket, M8, 4-pin Socket, M12, 5-pin Open cable end | – – – | – – – |
| | | [4] NEDY-... (modular system for all types of sensor/actuator distributor) | 2x socket, M8, 3-pin 2x socket, M8, 4-pin 2x socket, M12, 5-pin 2x socket, type A 2x socket, type B 2x socket, type C 2x socket, plug pattern H 2x socket, plug pattern ZB 2x socket, plug pattern ZC 2x open cable end | – – – – – – – – – – | – – – – – – – – – – |
| | | [5] NEDY-L2R1-V1-M8G3-N-M12G4 (T-adapter) | Plug M12, 4-pin to 2x socket, M8, 3-pin | – | – |
| | | [5] NEDY-L2R1-V1-M12G5-N-M12G4 (T-adapter) | Plug M12, 4-pin to 2x socket M12, 5-pin | – | – |
| | | | | [6] SEA-GS-M8 | Solder lugs |
| | | | | [6] SEA-3GS-M8-S | Screw terminals |
| | | | | [7] NEBU-...-M8G3 (modular system for choice of connecting cables) | Socket, M8, 3-pin Socket, M8, 4-pin Socket, M12, 5-pin Open cable end |
| | | | | [6] SEA-GS-7 | Screw terminals |
| | | | | [6] SEA-4GS-7-2.5 | Screw terminals |
| | | | | [6] SEA-GS-9 | Screw terminals |
| | | | | [6] SEA-M12-5GS-PG7 | Screw terminals |
| | | | | [6] SEA-GS-11-DUO | Screw terminals, for two cables |
| | | | | [6] SEA-5GS-11-DUO | Screw terminals, for two cables |
| | | | | [7] NEBU-...-M12G5 (modular system for choice of connecting cables) | Socket, M8, 4-pin Socket, M12, 5-pin Open cable end |

Key features – Electrical components

Electrical connection – Connection block (metal design)

CPX-M-AB-4-M12X2-5POL and CPX-M-AB-4-M12X2-5POL-T with connection socket M12, 5-pin

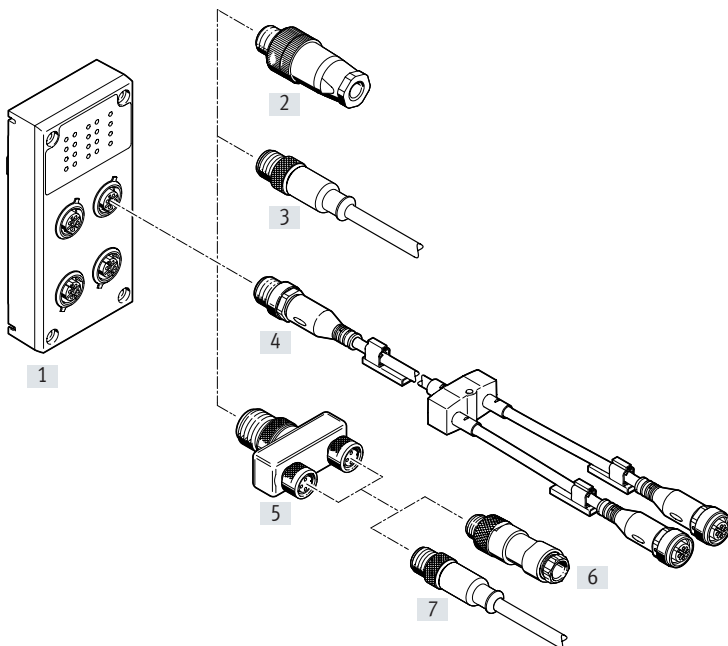

- Suitable for self-assembly and sturdy with 2 channels per connection
- 4 sockets
- 5-pin design per connection
- With two channels per connection, the corresponding input signals can be easily connected via a T-adaptor and conventional cables with M8 connection.

CPX-M-AB-8-M12X2-5POL and CPX-AB-8-M12X2-5POL with connection socket M12, 5-pin

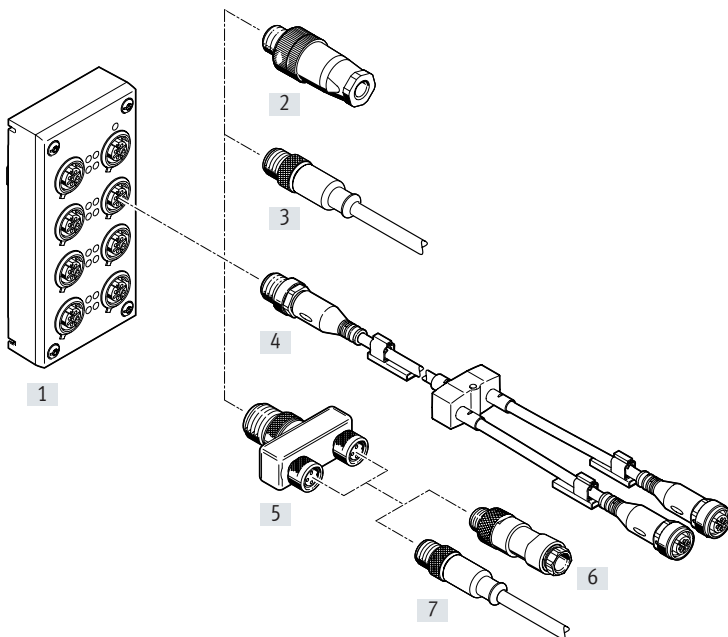

- Suitable for self-assembly and sturdy with 2 channels per connection
- 8 sockets
- 5-pin design per socket
- With two channels per connection, the corresponding input signals can be easily connected via a T-adaptor and conventional connecting cables with M8 connection.

 **Note**

Max. 4 T-adapters (NEDY) can be mounted on a connection block.

Key features – Electrical components

| Combination of connection block and electrical connection technology | | | | | |
|---|---------------------------------|--|--|---|-----------------------|
| Connection block | Connection technology | Plug/connecting cable | Connection technology | Plug/connecting cable | Connection technology |
| [1] CPX-M-AB-4-M12X2-5POL CPX-M-AB-4-M12X2-5POL-T CPX-M-AB-8-M12X2-5POL CPX-AB-8-M12X2-5POL | Socket, M12, 5-pin | [2] SEA-GS-7 | Screw terminals | – | – |
| | | [2] SEA-4GS-7-2.5 | Screw terminals | – | – |
| | | [2] SEA-GS-9 | Screw terminals | – | – |
| | | [2] SEA-M12-5GS-PG7 | Screw terminals | – | – |
| | | [2] SEA-GS-11-DUO | Screw terminals, for two cables | – | – |
| | | [2] SEA-5GS-11-DUO | Screw terminals, for two cables | – | – |
| | | [3] NEBU-...-M12G5 | Socket, M8, 4-pin | – | – |
| | | (modular system for choice of connecting cables) | Socket, M12, 5-pin | – | – |
| | | | Open cable end | – | – |
| | | | | | |
| | | [4] NEDY-... (modular system for all types of sensor/ actuator distributor) | 2x socket, M8, 3-pin | – | – |
| | | | 2x socket, M8, 4-pin | – | – |
| | | | 2x socket, M12, 5-pin | – | – |
| | | | 2x socket, type A | – | – |
| | | | 2x socket, type B | – | – |
| | | | 2x socket, type C | – | – |
| | | | 2x socket, plug pattern H | – | – |
| | | | 2x socket, plug pattern ZB | – | – |
| | | | 2x socket, plug pattern ZC | – | – |
| | | | 2x open cable end | – | – |
| | | [5] NEDY-L2R1-V1-M8G3-N-M12G4 (T-adapter) | Plug M12, 4-pin to 2x socket, M8, 3-pin | [6] SEA-GS-M8 | Solder lugs |
| | | | | [6] SEA-3GS-M8-S | Screw terminals |
| | | [5] NEDY-L2R1-V1-M12G5-N-M12G4 (T-adapter) | Plug M12, 4-pin to 2x socket M12, 5-pin | [7] NEBU-...-M8G3 (modular system for choice of connecting cables) | Socket, M8, 3-pin |
| | | | | | Socket, M8, 4-pin |
| | | | | | Socket, M12, 5-pin |
| | | | | | Open cable end |
| | | | | [6] SEA-GS-7 | Screw terminals |
| | | | | [6] SEA-4GS-7-2.5 | Screw terminals |
| | | | | [6] SEA-GS-9 | Screw terminals |
| | | | | [6] SEA-M12-5GS-PG7 | Screw terminals |
| [6] SEA-GS-11-DUO | Screw terminals, for two cables | | | | |
| [6] SEA-5GS-11-DUO | Screw terminals, for two cables | | | | |
| [7] NEBU-...-M12G5 (modular system for choice of connecting cables) | Socket, M8, 4-pin | | | | |
| | Socket, M12, 5-pin | | | | |
| | Open cable end | | | | |

Key features – Electrical components

Electrical connection – Connection block with M12, 4-pin connection

CPX-P-AB-4XM12-4POL

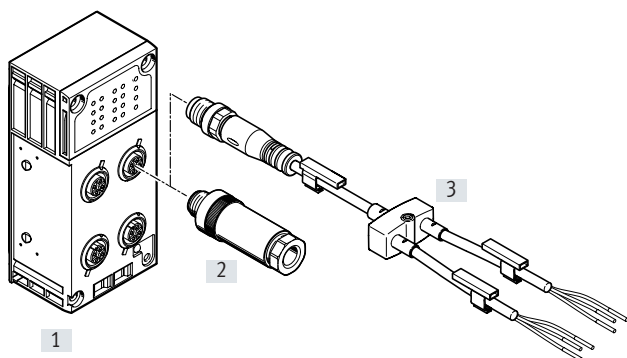

- Suitable for self-assembly and sturdy
- 4 sockets
- 4-pin design per connection

Combination of connection block and electrical connection technology

| Connection block | Connection technology | Plug/connecting cable | Connection technology |
|-------------------------|-----------------------|---|-----------------------------------|
| [1] CPX-P-AB-4XM12-4POL | Socket, M12, 4-pin | [2] SEA-GS-HAR-4POL | Insulation displacement connector |
| | | [2] SEA-4GS-7-2.5 | Screw terminal |
| | | [2] SEA-GS-7 | Screw terminal |
| | | [2] SEA-GS-9 | Screw terminal |
| | | [3] NEDY-... (modular system for all types of sensor/actuator distributor) | 2x open cable end |

Electrical connection – Connection block with clamping connector

CPX-P-AB-2XKL-8POL

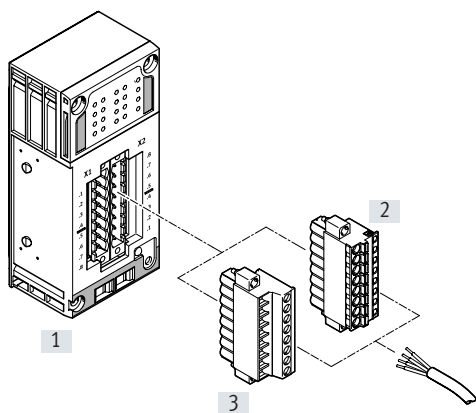

- Quick connection technology for use in control cabinets
- Spring-loaded terminals or screw terminals
- Wire cross sections 0.2 ... 2.5 mm²

Combination of connection block and electrical connection technology

| Connection block | Connection technology | Plug/connecting cable | Connection technology |
|------------------------|-----------------------|-----------------------|-------------------------|
| [1] CPX-P-AB-2XKL-8POL | Plug, 8-pin | [2] NECU-L3G8-C1 | Spring-loaded terminals |
| | | [3] NECU-L3G8-C2 | Screw terminals |

Key features – Electrical components

Electrical connection – Connection block

CPX-AB-4-M12-8POL with connection socket M12, 8-pin

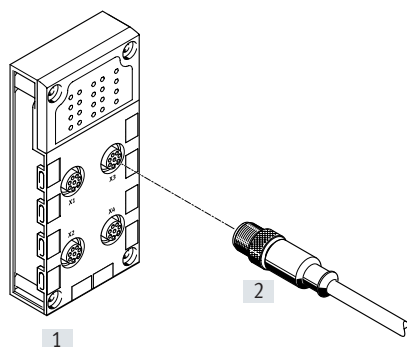

- Connection to cylinder/valve combinations with max. 3 inputs and 2 outputs
- 4 sockets
- 8-pin design per socket

Combination of connection block and electrical connection technology

| Connection block | Connection technology | Plug/connecting cable | Connection technology |
|-----------------------|-----------------------|---|-----------------------|
| [1] CPX-AB-4-M12-8POL | Socket, M12, 8-pin | [2] KM12-8GD8GS-2-PU (pre-assembled connecting cable) | Socket, M12, 8-pin |

CPX-AB-8-KL-4POL, CPX-2ZE2DA with spring-loaded terminal connection

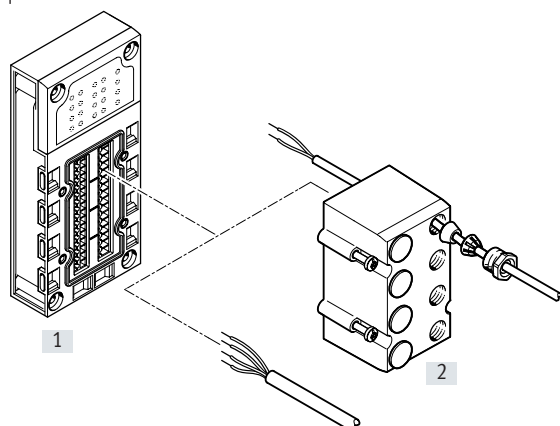

- Quick connection technology for use in control cabinets
- 32 spring-loaded terminals
- 4 spring-loaded terminals per channel
- Wire cross-sections 0.05 ... 1.5 mm²
- Optional cover with fittings for IP65, IP67 connection
 - 8 through-holes M9
 - 1 through-hole M16
 - Blanking plug
 - For I/O distributors, control desks or individual sensors/actuators

Combination of connection block and electrical connection technology

| Connection block | Connection technology | Plug/connecting cable | Connection technology |
|------------------------------------|---------------------------------|-----------------------|-----------------------|
| [1] CPX-AB-8-KL-4POL CPX-2ZE2DA | Spring-loaded terminals, 32-pin | [2] AK-8KL (cover) | – |

Key features – Electrical components

Electrical connection – Connection block

CPX-AB-1-SUB-BU-25POL with Sub-D connection, 25-pin

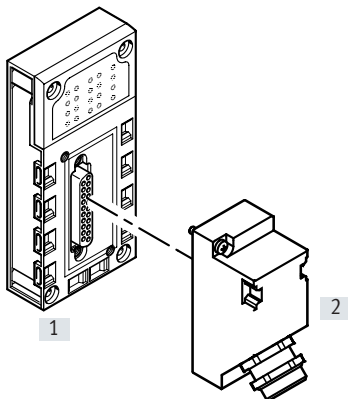

- Multi-pin connection for I/O distributor or control desk
- One socket
- 25-pin design

Combination of connection block and electrical connection technology

| Connection block | Connection technology | Plug/connecting cable | Connection technology |
|---------------------------|-----------------------|-----------------------|-----------------------|
| [1] CPX-AB-1-SUB-BU-25POL | Sub-D socket, 25-pin | [2] SD-SUB-D-ST25 | Crimp contacts |

Key features – Mounting

Hood

Description

→ Page 248

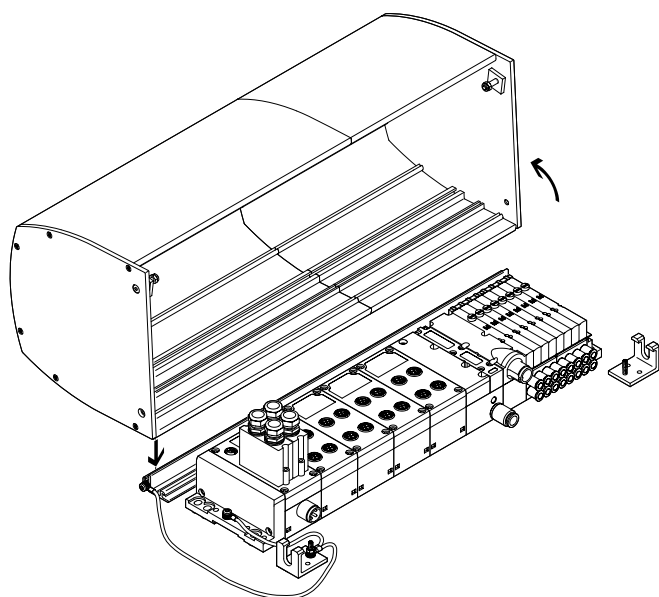

The CPX hood CAFC is a space- and cost-saving alternative to a control cabinet.

It is designed as an extruded aluminum profile and is installed on a mounting plate.

The valve terminal (CPX with MPA-S or MPA-L) is well protected and is quick to install without the need for complex cabinet through feed for connecting cables and tubing.

The rail and the two mounting brackets are mounted on a base plate. The hood is attached to the retaining rail and secured with two screws. There is also a stand-by position (latching of the hood in the open position).

The hood is locked using two side screws (which meet the requirements for a special lock in compliance with ATEX).

The CPX hood can be ordered online using the valve terminal configurator.

Advantages of the CPX hood

- Impact protection (min. 7 J) for the modules underneath in combination with a suitable mounting plate provided by the user
- Protection against electrostatic discharge by using electrically conductive materials and the option of connecting an earth wire
- Protection against disconnection of live plugs (by securing the hood with at least one special fastener to EN 60079-0, 9.2 and 20)
- UV protection for the CPX and MPA modules underneath

Points to note when using the CPX hood

- Only in combination with valve terminal MPA-S and MPA-L
- No bus nodes with push-pull connection (CPX-M-FB45)
- CPX power supply via angled plugs, no T plugs, no push-pull
- Electrical supply plate/additional supply only possible with angled plug
- No MPA vertical stacking
- Use of larger fittings (for tubing O.D. 12 mm and larger) only possible with the angled design
- Ducted exhaust air only with elbow connector
- The permissible ambient temperature range of the valve terminal is reduced by 5°C.

 **Note**

The CPX hood has no influence on the ATEX classification of the valve terminal or of the CPX terminal.

The CPX hood has no influence on the IP degree of protection of the valve terminal or of the CPX terminal.

The CPX hood does not protect against the effects of the weather in installations that are not in enclosed spaces.

Key features – Mounting

Hood Mounting

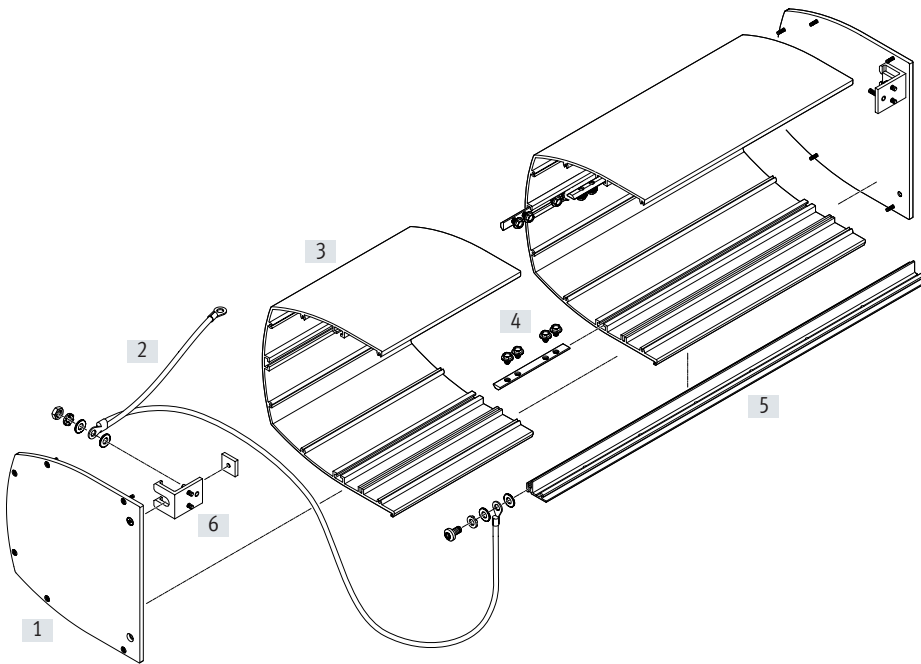

Procedure:

- Assemble the rail and mounting bracket included in the mounting kit
- Attach the earthing cable
- Assemble the hood (if applicable, screw together several hood sections and attach the side covers)
- Attach and secure the hood

- [1] Side cover
- [2] Earthing cable
- [3] Hood section
- [4] Slot nut with screws, for joining the hood sections
- [5] Rail
- [6] Mounting bracket

Technical data

Weight:

- Hood: approx. 500 g per 100 mm of length
- Mounting rail: approx. 550 g per 1000 mm of length
- Side pieces: approx. 500 g per side

- Ambient temperature –5 ... +50°C

- RoHS-compliant

Plug coding

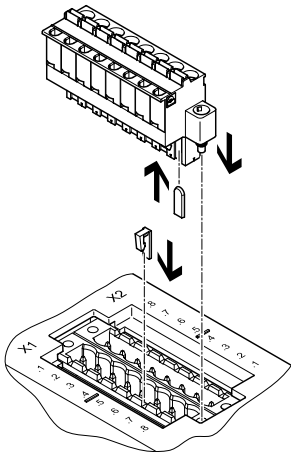

The connection block CPX-P-AB-2XKL-8POL and the sockets NECU-L3G8 can be matched to one another using the coding elements CPX-P-KDS-AB-2XKL.

This reduces the possibility of the socket being plugged back into an incorrect slot after being disconnected from the CPX terminal (connection safeguard).

Key features – Mounting

Extension

Functional principle

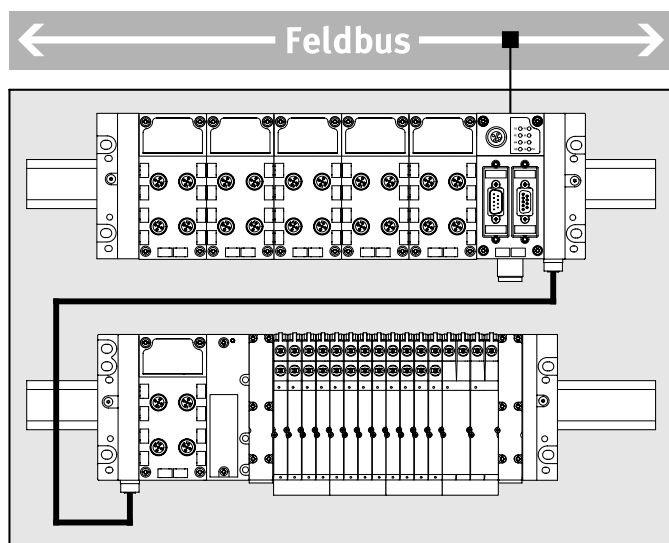

The extension enables the CPX terminal to be separated into or configured as two interconnected units (series). The two parts are controlled by a common bus node or control block. A comprehensive CPX terminal can fit into limited installation spaces more easily as two more compact units.

Applications:

- Installation in a control cabinet on two levels, one beneath the other
- Installation in two separate control cabinets
- Installation of part of the CPX terminal inside and part outside the control cabinet
- Spatial separation of electrics and pneumatics

Performance limits

- A maximum of 10 CPX modules can be installed in the first row
 - A maximum of 8 CPX modules and a pneumatic interface can be installed in the second row
- The number of CPX modules and solenoid coils is also limited by:
- the address space made available by the control block/bus node
 - their address requirement
 - their current consumption

Optimisation

- The maximum possible performance or maximum number of modules can only be achieved if the following conditions are observed:
- The control block/bus node is installed in the first row, on the far right, on an interlinking block with system supply
 - The connecting cable between the first and second row is max. 2 m long
 - An interlinking block with additional supply for valves is situated in the second row

Configuration rules

- The extension limits the power supply for the sensors and electronics for the CPX terminal as a whole as follows:
- First row max. 6 A
 - Second row max. 2 A
 - First and second row together, max. 6 A
- If the 3 m connecting cable is used, the following restrictions apply:
- There can only be one CPX module in the second row
 - An additional supply for valves is required in order to connect a valve terminal
- When positioning output modules in the second row, a corresponding power supply in the second row is required:
- Install an interlinking block with additional supply for outputs in the second row to the left of the first output module

Key features – Mounting

| Extension – Permissible CPX modules | Type | First row | Second row |
|---|--|--|-----------------|
| Control blocks | CPX-CEC | Permissible, at least one control block or bus node required | Not permissible |
| Bus node | CPX-FB CPX-M-FB | Permissible, at least one control block or bus node required | Not permissible |
| Gateway | CPX-IOT | Not permissible | Not permissible |
| Technology modules | CPX-CP CPX-CTEL CPX-CTEL-2 CPX-CM-HPP CPX-CMAX CPX-CMPX CPX-CMIX | Permissible | Not permissible |
| Input/output modules | CPX | Permissible | Permissible |
| PROFIsafe shut-off module | CPX-FVDA-P2 | Not permissible | Not permissible |
| Interlinking block/end plate with system supply | CPX-EPL-EV-S CPX-GE-EV-S CPX-M-GE-EV-S | Permissible, at least one interlinking block/end plate with system supply required | Not permissible |
| Interlinking block with additional supply | CPX-GE-EV-Z CPX-M-GE-EV-Z CPX-GE-EV-V | Permissible | Permissible |
| Interlinking block without power supply | CPX-GE-EV CPX-M-GE-EV | Permissible | Permissible |
| Interlinking block with system forwarding | CPX-M-GE-EV-W | Not permissible | Not permissible |
| Pneumatic interface | VMPA-FB | Not permissible | Permissible |
| | VMPAL-EPL-CPX | Not permissible | Permissible |
| | VABA-S6-1 | Not permissible | Permissible |
| | VABA-S6-1...CB | Not permissible | Not permissible |

Key features – Mounting

| Extension – Maximum number of CPX modules/solenoid coils | | |
|--|----------------|---|
| Special features of the design | First row | Second row |
| CPX terminal with valve terminal | | |
| Connecting cable 3 m | 10 CPX modules | Valve terminal MPA-S with: <ul style="list-style-type: none"> • Pneumatic interface for CPX metal interlinking module • Electrical supply plate VMPA-FB-SP directly after the pneumatic interface • Electronics modules with galvanic isolation • 128 solenoid coils (64 valve positions) |
| | | Valve terminal VTSA/VTSA-F with: <ul style="list-style-type: none"> • 1 CPX module with interlinking block with additional supply for valves • 32 solenoid coils (32 valve positions) |
| CPX terminal without valve terminal | | |
| • Control block/bus node not in position on the far right of the first row | 10 CPX modules | • 2 ... 5 CPX modules, depending on the control block/bus node used |
| • Control block/bus node in position on the far right of the first row | 10 CPX modules | • 4 ... 8 CPX modules, depending on the control block/bus node used |
| CPX terminal with valve terminal MPA-S | | |
| – | 10 CPX modules | • 2 ... 5 CPX modules and connection blocks MPA-S, depending on the control block/bus node used |
| • Electrical supply plates VMPA-FB-SP • Electronics modules with galvanic isolation | 10 CPX modules | • 2 ... 5 CPX modules, depending on the control block/bus node used • Up to 128 solenoid coils (64 valve positions) |
| • Control block/bus node in position on the far right of the first row • CPX-FB11 or CPX-CEC not possible | 10 CPX modules | • 4 ... 5 CPX modules and connection blocks MPA-S, depending on the control block/bus node used |
| • CPX-FB13 or CPX-FB36 • Control block/bus node in position on the far right of the first row • Interlinking block with system supply in position on the far right of the first row | 10 CPX modules | • 8 CPX modules and connection blocks MPA-S |
| • CPX-FB13 or CPX-FB36 • Control block/bus node in position on the far right of the first row • Interlinking block with additional supply for valves in position on the far right of the first row | 10 CPX modules | • 8 CPX modules and connection blocks MPA-S |
| • CPX-FB13 or CPX-FB36 • Control block/bus node in position on the far right of the first row • Interlinking block with additional supply for valves in second row | 10 CPX modules | • 8 CPX modules and connection blocks MPA-S |

Key features – Mounting

| Extension – Maximum number of CPX modules/solenoid coils Special features of the design | First row | Second row |
|--|----------------|--|
| CPX terminal with valve terminal MPA-L | | |
| – | 10 CPX modules | <ul style="list-style-type: none"> • 2 CPX modules (at least one CPX module required) • 16 solenoid coils (valve widths 10 mm and 14 mm) or 8 solenoid coils (valve width 20 mm) |
| • Interlinking block with additional supply for valves in second row | 10 CPX modules | <ul style="list-style-type: none"> • 2 CPX modules (at least one CPX module required) • 32 solenoid coils (32 valve positions) |
| CPX terminal with valve terminal VTSA/VTSA-F | | |
| – | 10 CPX modules | <ul style="list-style-type: none"> • 2 CPX modules • 12 solenoid coils (valve widths 18 mm, 26 mm and 42 mm) or 6 solenoid coils (valve widths 52 mm and 65 mm) |
| • Interlinking block with additional supply for valves in second row | 10 CPX modules | <ul style="list-style-type: none"> • 2 CPX modules • 32 solenoid coils (32 valve positions) |

Key features – Mounting

Mounting options

Valve terminals with CPX terminal support different mounting options for direct machine mounting with a high degree of protection and control cabinet installation.

H-rail mounting

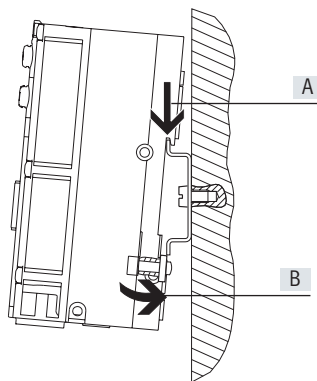

The H-rail mounting is part of the rear profile of the CPX interlinking blocks. The CPX terminal can be attached to the H-rail using the H-rail mounting kit. The CPX terminal is first hooked onto the H-rail (see arrow [A]),

then swivelled onto the H-rail and secured in place with the clamping element (see arrow [B]).

The optional earthing plate enables a connection to be established to the machine potential/earth in one easy step.

The following mounting kit is needed for H-rail mounting:

- CPX-CPA-BG-NRH

This facilitates mounting of the CPX terminal on H-rails to EN 60715.

An additional mounting kit may be required for combination with valve terminals.

Wall mounting

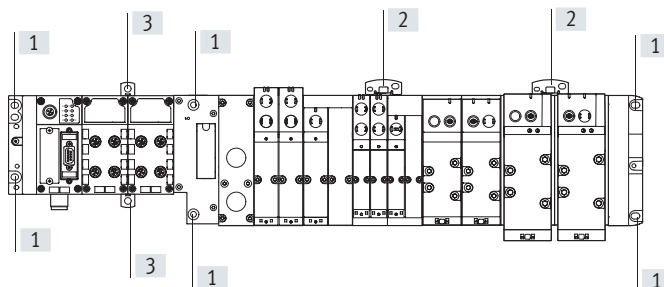

The end plates of the CPX terminal, the valve terminal and the pneumatic interface include mounting holes [1] for wall mounting. Additional mountings [2] for the CPX terminal are available for longer valve terminals.

These mountings differ depending on the design of the CPX terminal (plastic or metal).

In the case of 4 and more interlinking blocks, additional wall mountings must be used every 100 ...150 mm:

- Type CPX-M-BG-RW (metal design). These wall mountings are screwed in at the top on the CPX module.
- Type CPX-BG-RW (plastic design). These wall mountings are hooked in at the top and bottom between the CPX modules.

Key features – Mounting

CPX terminal in plastic design

Additional mountings

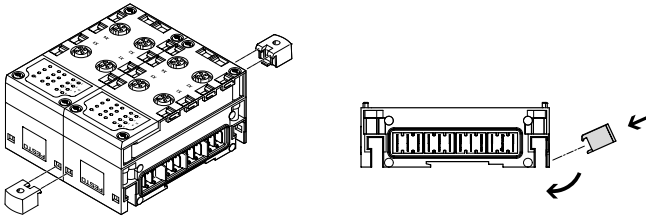

For longer valve terminals, there are additional mounting components for the CPX terminal that can be fitted between two modules.

Note

For CPX terminals with 4 or more interlinking blocks, you need additional mounting components of type CPX-BG-RW every 100 or 150 mm. These are supplied pre-assembled.

Interlinking with tie rods

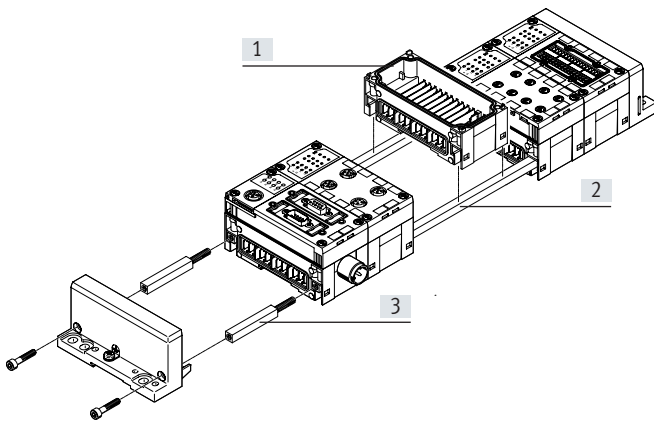

The mechanical connection between the CPX modules is created using special tie rods [2]. The entire unit can be assembled using two screws in the end plates.

The tie rod ensures that the unit has a high mechanical load-bearing capacity and is therefore the mechanical “backbone” of the CPX terminal.

The open design allows interlinking blocks [1] to be replaced when already mounted.

With the tie rod extension kit [3] an extra module can be added to the CPX terminal.

CPX terminal in metal design

Additional mountings

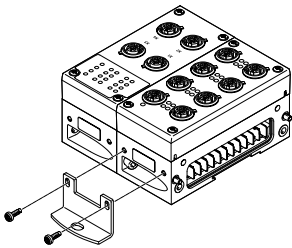

For longer valve terminals, there are additional mounting brackets for the CPX terminal that can be screwed onto the interlinking blocks.

The mounting bracket CPX-M-BG-VT-2X enables a CPX terminal with valve terminal VTSA/VTSA-F/VTSA-F-CB to be mounted on a support system.

Note

In the case of CPX terminals with 4 or more interlinking blocks, additional mounting brackets of the type CPX-M-BG-RW must be used every 100 or 150 mm. These are supplied pre-assembled.

Linking with screws

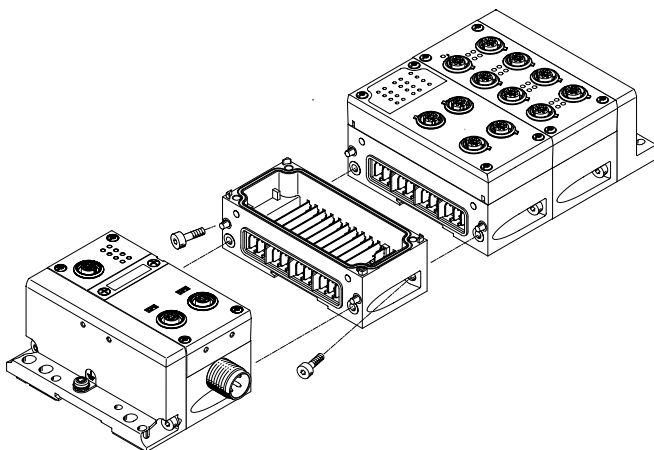

The CPX modules are mechanically connected using an angled fitting. The CPX terminal can thus be expanded at any time.

Key features – Power supply

Power supply concept

General

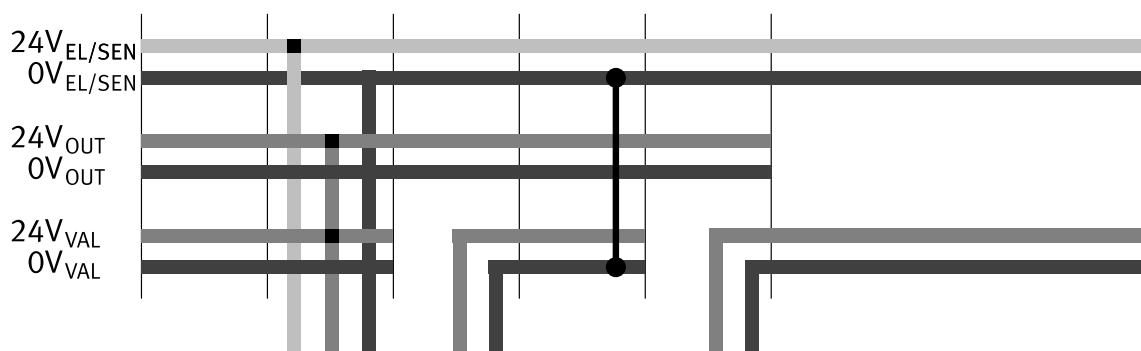
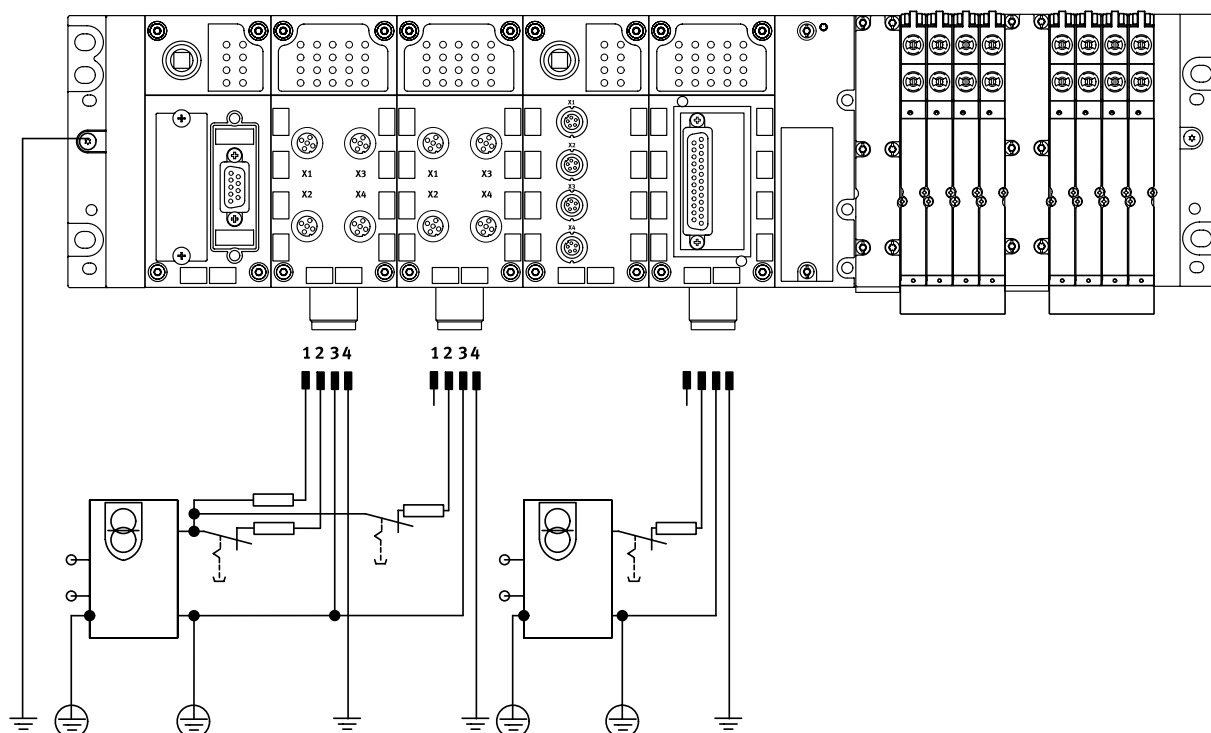

The use of decentralised devices on the fieldbus – particularly with a high degree of protection for direct machine mounting – demands a flexible power supply concept.

A valve terminal with CPX is, in principle, supplied with all voltages via a single connection.

A distinction is made between the supply for

- Electronics plus sensors
- Valves plus actuators

in this case.

Selectable connection technology:

- M18
- 7/8"
- M12x1
- AIDA push-pull

Interlinking blocks

Interlinking blocks represent the backbone of the CPX terminal with all supply lines. They provide the power supply for the modules used on them as well as their bus connections.

Many applications require the CPX terminal to be separated into voltage zones. This applies in particular to the separate disconnection of solenoid coils and outputs.

The interlinking blocks provide either an easy-to-install central power supply for the entire CPX terminal or galvanically isolated, all-pin disconnectable potential groups/voltage segments.

Key features – Power supply

Interlinking blocks

With system supply

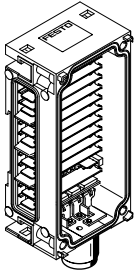

Plastic design

- CPX-GE-EV-S
- CPX-GE-EV-S-7/8-4POL
- CPX-GE-EV-S-7/8-5POL

Metal design

- CPX-M-GE-EV-S-7/8-CIP-4P
- CPX-M-GE-EV-S-7/8-5POL
- CPX-M-GE-EV-S-M12-5POL
- CPX-M-GE-EV-S-PP-5POL

Connection technology

- M18, 4-pin
- 7/8" 4-pin
- 7/8" 5-pin

Connection technology

- 7/8" 4-pin
- 7/8" 5-pin
- M12x1, L-coded, 5-pin
- AIDA push-pull, 5-pin

Power supply

- For CPX terminal modules and connected sensors
- For valves that are connected to the CPX terminal via a pneumatic interface
- For actuators that are connected to the output modules of the CPX terminal

Without power supply

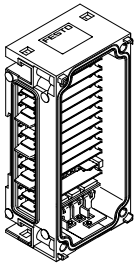

Plastic design

- CPX-GE-EV

Metal design

- CPX-M-GE-EV
- CPX-M-GE-EV-FVO

–

–

–

With additional supply for outputs

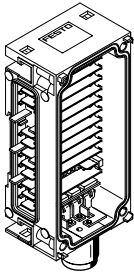

Plastic design

- CPX-GE-EV-Z
- CPX-GE-EV-Z-7/8-4POL
- CPX-GE-EV-Z-7/8-5POL

Metal design

- CPX-M-GE-EV-Z-7/8-5POL
- CPX-M-GE-EV-Z-PP-5POL

Connection technology

- M18, 4-pin
- 7/8" 4-pin
- 7/8" 5-pin

Connection technology

- 7/8" 5-pin
- AIDA push-pull, 5-pin

Power supply

- For actuators that are connected to output modules of the CPX terminal

With additional supply for valves

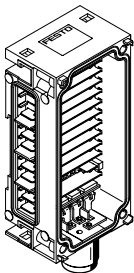

Plastic design

- CPX-GE-EV-V
- CPX-GE-EV-V-7/8-4POL

Connection technology

- M18, 4-pin
- 7/8" 4-pin

Power supply

- For valves that are connected to the CPX terminal via a pneumatic interface

 **Note**

For 7/8":

- Commercially available accessories are often limited to max. 8 A

 **Note**

The valve terminal MPA-S has either a 7/8" 5-pin, 7/8" 4-pin, 3-pin M18 or 5-pin AIDA push-pull power supply for one or more valve voltage zones. Galvanically isolated, all-pin disconnectable with voltage monitoring in the following MPA module.

 **Note**

Suitable versions of the interlinking blocks with M18 and 7/8", 5-pin connection are available (CPX-GE-EV-...-VL and CPX-M-GE-EV-...-VL) for use in ATEX environments as per certification (→ page 49). The maximum current supply for these interlinking blocks is 8 A.

Key features – Power supply

Interlinking blocks

With system forwarding

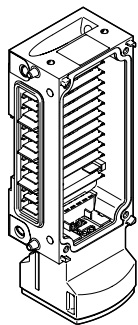

Metal design

- CPX-M-GE-EV-W-M12-5POL

Connection technology

- M12x1, L-coded, 5-pin

Voltage transmission

- For a further CPX terminal

Key features – Diagnostics

Diagnostics

System performance

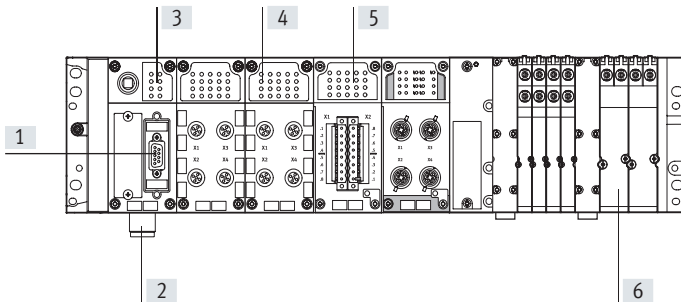

- [1] Diagnostics via bus interface
- [2] Undervoltage monitoring
- [3] Diagnostic overview LED
 - Fieldbus status
 - CPX status
- [4] Status and diagnostic LED for module and I/O channels
- [5] Module and channel-specific diagnostics
- [6] Valve-specific diagnostic module and solenoid coils
- [7] MPA pressure sensor – integrated solution on the fieldbus
 - Pre-assembled for channels 1, 3, 5 and external pressures

Detailed diagnostic functions are needed in order to quickly locate the causes of errors in the electrical installation and therefore reduce downtimes in production plants.

A basic distinction is made between on-the-spot diagnostics using LEDs or a diagnostic interface and diagnostics using a bus interface.

The CPX terminal supports on-the-spot diagnostics via a row of LEDs. This is separate from the connection area and therefore provides good visual access to status and diagnostic information.

Module and channel-specific diagnostics are supported, for example:

- Undervoltage detection for outputs and valves
- Short circuit detection for sensors, outputs and valves
- Open-load detection for a missing solenoid coil
- Storage of the last 40 causes of errors with error start and error end

The diagnostic messages can be read out via the bus interface in the higher-order controller and visualised for the central recording and evaluation of error causes. This is done using the individual fieldbus-specific channels. CPX-CECs also offer the option of access via the integrated Ethernet interface (remote maintenance via PC/web applications).

Overview of LEDs on the bus node

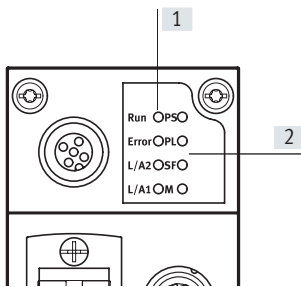

[1] Fieldbus-specific LEDs
On each bus node, a maximum of 4 fieldbus-specific LEDs display the fieldbus communication status of the CPX terminal with the higher-order controller.

[2] CPX-specific LEDs
A further 4 CPX-specific LEDs provide non-fieldbus-specific information about the status of the CPX terminal, for example:

- Power system
- Power load
- System fault
- Modify parameters

Input/output module status and diagnostic LEDs

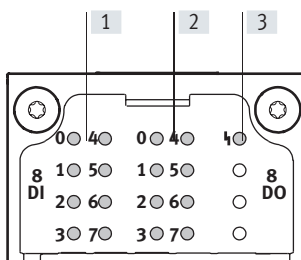

[1] Status LEDs for the inputs and outputs
Each input and output channel is assigned a status LED.

[2] Channel-oriented diagnostic LEDs
Depending on the module design, another diagnostic LED is available for each I/O channel

[3] Group diagnostic LEDs
An LED displays the group diagnostics for each module

Key features – Diagnostics

Diagnostics

Display on a PC

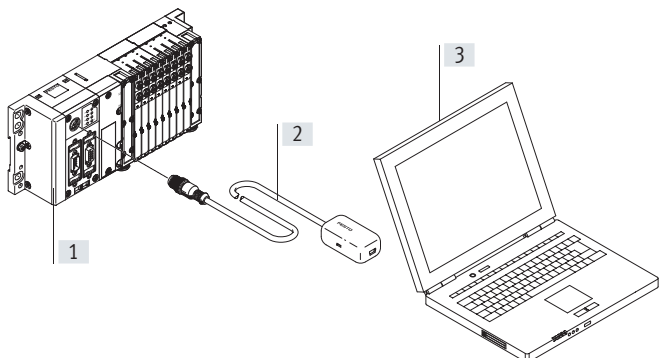

- [1] CPX terminal with valve terminal
- [2] Adapter diagnostic interface to USB
- [3] Laptop/portable device with USB interface and installed FMT software
 - Fault location and type
 - Without programming
 - Storing the configuration
 - Preparing screenshots

Data gathering via gateway

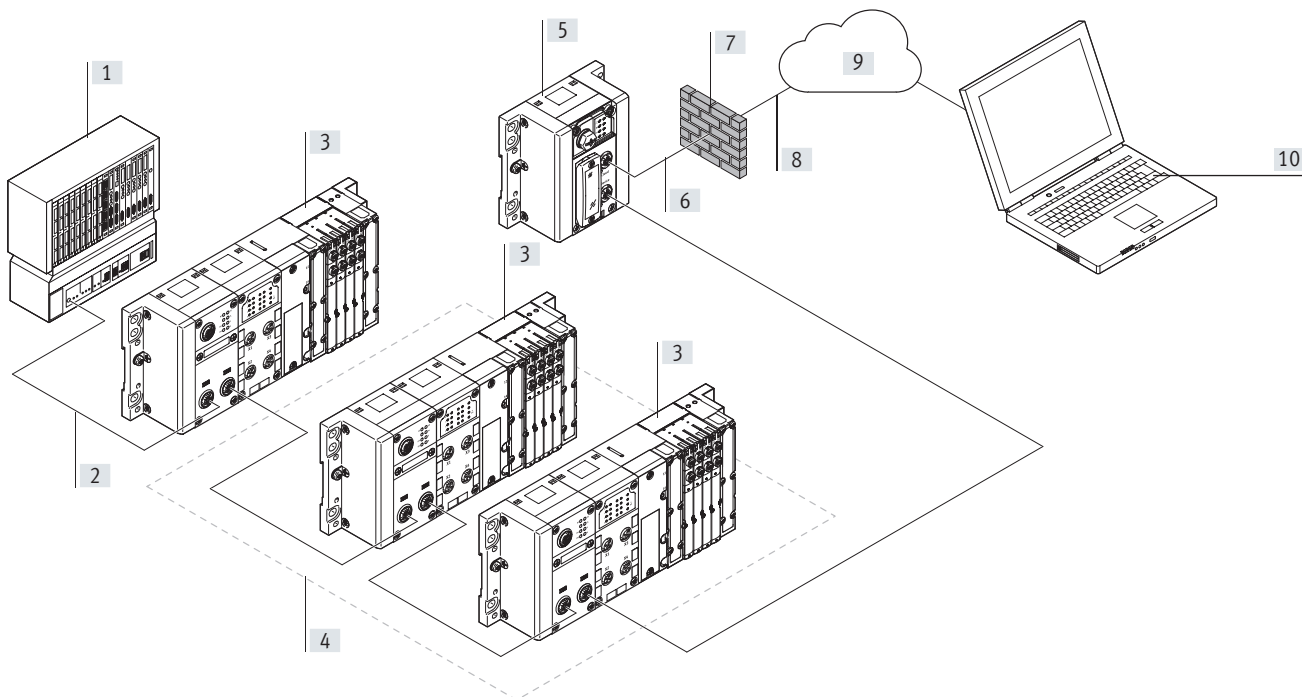

- [1] PLC to machine/system controller (no direct internet connection)
- [2] Bus system from the controller to the system parts (e.g. PROFINET)
- [3] Festo components with bus connection with serial linking
- [4] Components from which the CPX-IOT is collecting and transferring data
- [5] Gateway CPX-IOT
- [6] Internet connection
- [7] Customer firewall or other security precautions
- [8] Transferring data to a central storage location (MQTT broker) using secure protocols
- [9] Central storage location (user-specific MQTT broker) provided by Festo
- [10] Simple decentralised evaluation of data using adapted programs (apps) for the components that are being monitored

Key features – Parameterisation

Parameterisation

Changes to the application are often required during commissioning. The parameterisable characteristics of the CPX modules mean that functions can be very easily changed using configuration software. This reduces the number of modules needed and, consequently, the amount of storage space required.

It is therefore possible, for example, to reduce the input debounce time for an input module – normally 3 ms – to 0.1 ms on a "fast" input module for faster processes, or to set the response of a valve following a fieldbus interruption.

Depending on the modules used, parameterisation can be carried out via the following interfaces:

- Ethernet
- Fieldbus
- Control block direct interface (programming interface)

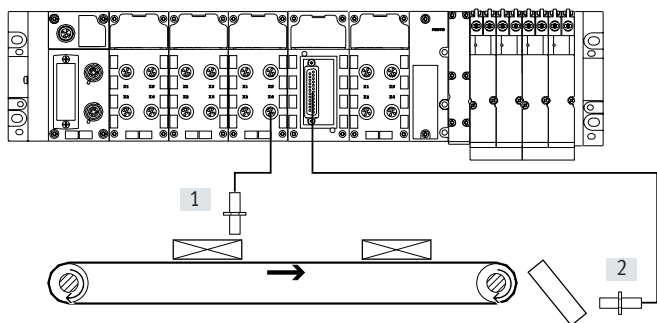

- [1] Input debounce time 3 ms
[2] Input debounce time 0.1 ms

Key features – Addressing

Addressing

The various CPX modules occupy a different number of I/O addresses within the CPX system. The maximum address space for bus nodes depends on the performance of the fieldbus systems.

Maximum system configuration:

- 1 bus node or control block
- 9 I/O modules
- 1 pneumatic interface (e.g. pneumatic interface MPA-S with up to 16 MPA connection blocks)

The maximum system configuration can be limited in individual cases by exceeding the address space.



Note

Please refer to the detailed description of the configuration/addressing rules in the technical data for CPX bus nodes.

Overview – Address space for CPX bus node and control block

| | Protocol | Max. total | | Max. digital | | Max. analogue | |
|-------------|--|------------|----------|-----------------|-----------------|---------------|---------------|
| | | Inputs | Outputs | Inputs | Outputs | Inputs | Outputs |
| CPX-CEC | <ul style="list-style-type: none"> • CODESYS Level 2 • TCP/IP • Easy IP • Modbus TCP | 512 bits | 512 bits | 512 DI | 512 DO | 32 AI | 18 AO |
| CPX-FB11 | DeviceNet | 512 bits | 512 bits | 512 DI | 512 DO | 32 AI | 18 AO |
| CPX-FB13 | PROFIBUS | 512 bits | 512 bits | 512 DI | 512 DO | 32 AI | 18 AO |
| CPX-FB14 | CANopen | 256 bits | 256 bits | 64 DI (+ 64 DI) | 64 DO (+ 64 DO) | 8 AI (+ 8 AI) | 8 AO (+ 8 AO) |
| CPX-FB23-24 | CC-Link | 512 bits | 512 bits | 512 DI | 512 DO | 32 AI | 18 AO |
| CPX-FB36 | EtherNet/IP | 512 bits | 512 bits | 512 DI | 512 DO | 32 AI | 18 AO |
| CPX-FB37 | EtherCAT | 512 bits | 512 bits | 512 DI | 512 DO | 32 AI | 18 AO |
| CPX-FB39 | Sercos III | 512 bits | 512 bits | 512 DI | 512 DO | 32 AI | 18 AO |
| CPX-FB40 | POWERLINK | 512 bits | 512 bits | 512 DI | 512 DO | 32 AI | 18 AO |
| CPX-FB43 | PROFINET RT | 512 bits | 512 bits | 512 DI | 512 DO | 32 AI | 18 AO |
| CPX-M-FB44 | PROFINET RT | 512 bits | 512 bits | 512 DI | 512 DO | 32 AI | 18 AO |
| CPX-M-FB45 | PROFINET RT | 512 bits | 512 bits | 512 DI | 512 DO | 32 AI | 18 AO |



Note

The bandwidth of the bus nodes can be restricted by the choice of module and the maximum number of modules.

Example – CPX-FB43 (PROFINET RT)

| | Digital inputs | Digital outputs | Remarks |
|-------------------------|----------------|-----------------|--|
| 1x CPX-CM-HPP | 256 | 256 | <ul style="list-style-type: none"> • The address space is occupied by 7 CPX I/O modules plus pneumatic interface • No additional modules can be configured |
| 2x CPX-2ZE2DA | 192 | 192 | |
| 4x CPX-16DE | 64 | – | |
| 8x VMPA1 | – | 64 | |
| Allocated address space | 512 | 512 | |

DI = Digital inputs (1 bit)

DO = Digital outputs (1 bit)

AO = Analogue outputs (16 bits)

AI = Analogue inputs (16 bits)

Key features – Addressing

| Overview – Allocated addresses for CPX modules | | |
|--|--|---|
| | Inputs [bit] | Outputs [bit] |
| CPX-CP-4-FB | 16, 32, 48, 64, 80, 96, 128 ¹⁾ | 16, 32, 48, 64, 80, 96, 128 ¹⁾ |
| CPX-CTEL-4-M12-5POL | 0, 64, 128, 192, 256 ¹⁾ | 0, 64, 128, 192, 256 ¹⁾ |
| CPX-CTEL-2-M12-5POL-LK | 64, 128, 192, 256 ¹⁾ | 64, 128, 192, 256 ¹⁾ |
| CPX-CM-HPP | 256 | 256 |
| CPX-CMAX-C1-1 | 64 | 64 |
| CPX-CMPX-C1-H1 | 48 | 48 |
| CPX-CMIX-M1-1 | 48 | 48 |
| CPX-4DE | 4 | – |
| CPX-8DE | 8 | – |
| CPX-8DE-D | 8 | – |
| CPX-8NDE | 8 | – |
| CPX-P-8DE-N | 16 | 8 |
| CPX-P-8DE-N (inputs configured as counter) | 80 | 16 |
| CPX-F8DE-P | 48 | 56 |
| CPX-16DE | 16 | – |
| CPX-M-16DE-D | 16 | – |
| CPX-L-16DE-16-KL-3POL | 16 | – |
| CPX-4DA | – | 4 |
| CPX-8DA | – | 8 |
| CPX-8DA-H | – | 8 |
| CPX-8DE-8DA | 8 | 8 |
| CPX-L-8DE-8DA-16-KL-3POL | 8 | 8 |
| CPX-2ZE2DA | 96 | 96 |
| CPX-4AE-4AA-H | 0, 16, 32, 48, 64, 128, 144, 160, 176, 192 ¹⁾ | 0, 16, 32, 48, 64 ¹⁾ |
| CPX-2AE-U-I | 2 x 16 | – |
| CPX-4AE-U-I | 4 x 16 | – |
| CPX-4AE-I | 4 x 16 | – |
| CPX-4AE-P-B2 | 4 x 16 | – |
| CPX-4AE-P-D10 | 4 x 16 | – |
| CPX-4AE-T | 4 x 16 | – |
| CPX-4AE-TC | 4 x 16 | – |
| CPX-2AA-U-I | – | 2 x 16 |
| CPX-FVDA-P2 | 48 | 48 |
| VMPA1-FB-EMS-8 | – | 8 |
| VMPA1-FB-EMG-8 | – | 8 |
| VMPA2-FB-EMS-4 | – | 4 |
| VMPA2-FB-EMG-4 | – | 4 |
| VMPA1-FB-EMS-D2-8 | – | 8 |
| VMPA1-FB-EMG-D2-8 | – | 8 |
| VMPA2-FB-EMS-D2-4 | – | 4 |
| VMPA2-FB-EMG-D2-4 | – | 4 |
| VMPA-FB-PS-1 | 16 | – |
| VMPA-FB-PS-3/5 | 16 | – |
| VMPA-FB-PS-P1 | 16 | – |
| VMPA-FB-EMG-P1 | 16 | 16 |
| VMPAL-EPL-CPX | – | 4, 8, 16, 24, 32 ¹⁾ |
| VABA-S6-1-X1 | – | 8, 16, 24, 32 ¹⁾ |
| VABA-S6-1-X2 | – | 8, 16, 24, 32 ¹⁾ |
| VABA-S6-1-X2-D | 8, 16, 24, 32 ¹⁾ | 8, 16, 24, 32 ¹⁾ |
| VABA-S6-1-X1-CB | – | 8, 16, 24 ¹⁾ |
| VABA-S6-1-X2-CB | – | 8, 16, 24 ¹⁾ |
| VABA-S6-1-X2-F1-CB | – | 8, 16, 24 ¹⁾ |
| VABA-S6-1-X2-F2-CB | – | 8, 16, 24 ¹⁾ |
| VABA-S6-1-X1-3V-CB | – | 8, 16, 24 ¹⁾ |
| VABA-S6-1-X2-3V-CB | – | 8, 16, 24 ¹⁾ |

1) Dependent on the DIL switch setting on the module

Data sheet

 Module width
50 mm



 **Note**

The data given here apply to the CPX system. If components that conform to lower values are used in the system, the specification for the entire system is reduced to the values for those components.

Example

Degree of protection IP65/IP67 applies only to the fully assembled system with fitted plugs or covers (which must also conform to IP65/IP67).

If components with a lower degree of protection are used, the protection level of the entire system is reduced to the degree of protection of the component with the lowest degree of protection, for example CageClamp connection block with degree of protection IP20 or MPA pneumatics with degree of protection IP65.

| General technical data | | |
|--------------------------------------|--|---|
| Module no. | | 197330 |
| Max. number of modules ¹⁾ | Control block | 1 |
| | Bus node | 1 |
| | I/O modules/CP interface/CTEL interface/electrical interface CPX-CTEL-2/multi-axis interface | 9 |
| | Pneumatic interface | 1 |
| Max. address capacity | Inputs [byte] | 64 |
| | Outputs [byte] | 64 |
| Internal cycle time | [ms] | < 1 |
| Configuration support | | Fieldbus-specific |
| LED displays | Bus node/control block/gateway | Up to 4 LEDs, bus-specific 4 LEDs, CPX-specific • PS = Power system • PL = Power load • SF = System fault • M = Modify parameter/forcing active |
| | | I/O modules Min. one centralised diagnostic LED Channel-oriented status and diagnostic LED, depending on module |
| | Pneumatic interface | One centralised diagnostic LED Valve status LED on valve |
| Diagnostics | | <ul style="list-style-type: none"> • Channel and module-oriented diagnostics for inputs/outputs and valves • Detection of module undervoltage for the different potential values • Storage of the last 40 errors with timestamp (acyclic access) |

1) A maximum of 11 modules in total can be combined (e.g. 1 control block + 9 I/O modules + 1 pneumatic interface, or 1 control block + 1 bus node + 8 I/O modules + 1 pneumatic interface)

Data sheet

| General technical data | | | |
|--|---------------------------------------|--|---|
| Module no. | | 197330 | |
| Parameterisation | | Diagnostic behaviour | |
| | | Fail-safe response | |
| | | Forcing of channels | |
| | | Signal setup | |
| Commissioning support | | Forcing of inputs and outputs | |
| Degree of protection to EN 60529 | | IP65, IP67 | |
| Nominal operating voltage | [V DC] | 24 | |
| Operating voltage range | [V DC] | 18 ... 30 | |
| Power supply | Interlinking block with system supply | | |
| | Electronics plus sensors | | |
| | Actuators plus valves | [A] | 16 (8/10 with 7/8" supply, 5-pin/4-pin) |
| | | [A] | 16 (8/10 with 7/8" supply, 5-pin/4-pin) |
| | Additional supply | | |
| Actuators | [A] | 16 (8/10 with 7/8" supply, 5-pin/4-pin) | |
| | Additional supply for valves | [A] | 16 (10 with 7/8" supply, 4-pin) |
| Current consumption | | Depending on system configuration | |
| Mains buffering (bus electronics only) | [ms] | 10 | |
| Power supply connection | | M18, 4-pin | |
| | | 7/8" 5-pin | |
| | | 7/8" 4-pin | |
| | | AIDA push-pull, 5-pin | |
| Fuse concept | | Per module with electronic fuses | |
| Tests | Vibration test to DIN IEC 68 | <ul style="list-style-type: none"> • With wall mounting: Severity level 2 • With H-rail mounting: Severity level 1 | |
| | Shock test to DIN IEC 68 | <ul style="list-style-type: none"> • With wall mounting: Severity level 2 • With H-rail mounting: Severity level 1 | |
| PWIS conformity | | VDMA24364-B2-L | |
| Immunity to interference | | EN 61000-6-2 (industry) | |
| Emitted interference | | EN 61000-6-4 (industry) | |
| Isolation test for galvanically isolated circuits to IEC 1131 Part 2 | [V DC] | 500 | |
| Galvanic isolation of electrical voltages | [V DC] | 80 | |
| Protection against direct and indirect contact | | PELV | |
| Materials | | End plates: Die-cast aluminium | |
| Grid dimension | [mm] | 50 | |
| Operating and environmental conditions | | | |
| Module no. | | 197330 | |
| Ambient temperature | [°C] | -5 ... +50 | |
| Storage temperature | [°C] | -20 ... +70 | |

Data sheet

| Certifications and approvals – Maximum values | |
|--|---|
| Module no. | 197330 |
| ATEX category gas | II 3G |
| Type of ignition protection for gas | Ex ec IIC T4 Gc X |
| Explosion-proof ambient temperature [°C] | -5 ≤ Ta ≤ +50 |
| CE marking (see declaration of conformity) ²⁾ | To EU Explosion Protection Directive (ATEX) |
| | To EU EMC Directive ¹⁾ |
| | To EU RoHS Directive |
| UKCA marking (see declaration of conformity) ²⁾ | To UK EX instructions |
| | To UK instructions for EMC |
| | To UK RoHS instructions |
| KC mark | KC EMC |
| Degree of protection to EN 60529 | IP65, IP67 |
| Certification | c UL us - Recognized (OL) |
| | RCM |
| Explosion protection certification outside the EU | EPL Gc (Ru) |
| | EPL Gc (GB) |

1) For information about the area of use, see the EC declaration of conformity at: www.festo.com/catalogue/... → Support/Downloads.

If the devices are subject to usage restrictions in residential, commercial or light-industrial environments, further measures for the reduction of the emitted interference may be necessary.

2) Additional information at: www.festo.com/catalogue/... → Support/Downloads.

 **Note**

The values indicated represent the maximum performance limits that can be achieved with the fully assembled product. Depending on the individual components used, the val-

ue actually achieved for the overall product may be lower. You can select e.g. the individual components required to achieve the ATEX category by choosing the corre-

sponding features in the online product configurator:
→ Internet:cpx





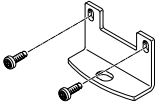
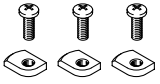
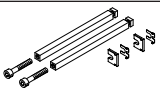
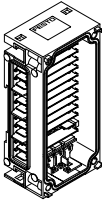
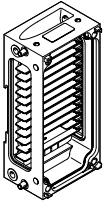

Data sheet

| Weights [g] | | | | | | |
|----------------|---|-----------------|--|---|--------------------------------------|-----|
| Control block | CEC | 155 | CP interface | CP | 139 | |
| | CEC...V3 | 135 | CTEL interface | CTEL | 110 | |
| Bus node | – | – | Electrical interface | CTEL-2 | 110 | |
| | FB11 | 120 | Axis interface | CM-HPP | 140 | |
| | FB13 | 115 | Axis controller | CMAX | 140 | |
| | FB14 | 115 | End-position controller | CMPX | 140 | |
| | – | – | Measuring module | CMIX | 140 | |
| | FB23-24 | 115 | Plastic connection block | 8-way, M8 3-pin | 62 | |
| | – | – | | 8-way, M8 4-pin | 65 | |
| | – | – | | 4-way, M12 5-pin | 60 | |
| | – | – | | 4-way, M12 5-pin, quick lock, shielded with metal thread | 87 | |
| | FB36 | 125 | | 8-way, M12 5-pin | 76 | |
| | FB37 | 125 | | 4-way, M12 8-pin | 65 | |
| | FB39 | 125 | | Spring-loaded terminal, 32-pin | 75 | |
| | FB40 | 125 | | Sub-D 25-pin | 72 | |
| | FB43 | 185 | | 8-way, DIL switch | 57 | |
| | FB44 | 280 | | | | |
| | FB45 | 280 | | | | |
| Gateway | IOT | 130 | Connection block for NAMUR and HART module | 4-way, M12 4-pin Clamping connector 8-pin | 120 100 | |
| I/O module | 4 digital outputs | 42 | Metal connection block | 4-way, M12 5-pin | 112 | |
| | 4 digital inputs | 39 | | 4-way, M12 5-pin, pulsed sensor supply | 110 | |
| | 8 digital inputs | 39 | | 8-way, M12 5-pin | 152 | |
| | 8 digital inputs, positive logic (PNP), enhanced diagnostic function | 45 | Plastic interlinking block | Without power supply | 108 | |
| | 8 digital inputs, negative logic (NPN) | 40 | | System supply | 125 | |
| | 8 digital inputs to NAMUR | 100 | Interlinking block, metal | Without power supply | 169 | |
| | 16 digital inputs, internal electronic fuse per module | 41 | | System supply, 7/8" 4-pin | 228 | |
| | 16 digital inputs, internal electronic fuse per channel pair, for CPX in metal | 46 | | System supply, 7/8" 5-pin | 187 | |
| | | | | System supply, M12x1 | 279 | |
| | | | | System supply, push-pull | 279 | |
| | 16 digital inputs, for CPX in plastic, including interlinking block and connection block with spring-loaded terminals | 167 | | System forwarding, M12x1 | 279 | |
| | 8 digital inputs, 8 digital outputs | 48 | Tie rods | 1-way | 41 | |
| | 8 digital inputs, 8 digital outputs, for CPX in plastic, including interlinking block and connection block with spring-loaded terminals | 171 | | 2-way | 71 | |
| | | | | 3-way | 97 | |
| | 8 digital outputs, power supply 0.5 A per channel | 49 | | 4-way | 127 | |
| | 8 digital outputs, power supply 2.1 A per channel pair | 48 | | 5-way | 156 | |
| | 2 analogue current or voltage inputs | 48 | | 6-way | 173 | |
| | | | | 7-way | 199 | |
| | 4 analogue current inputs | 47 | | 8-way | 247 | |
| | 2 analogue current or voltage outputs | 49 | | 9-way | 274 | |
| | | | | 10-way | 301 | |
| | 4 analogue inputs/outputs, HART | 77.4 | End plate for plastic design | Left-hand | 110 | |
| | 2 or 4 analogue temperature inputs | 47 | | Left-hand, with system supply | 145 | |
| | 4 analogue temperature inputs, with 2-wire connection for a PT1000 sensor for cold junction compensation | 46 | | Right-hand | 110 | |
| | 4 analogue pressure inputs | 115 | End plate for metal design | Left-hand | 113 | |
| | | | | Right-hand | 113 | |
| | PROFIsafe | Shut-off module | 50 | End plate with extension | Left-hand | 190 |
| | Input module | 46 | Right-hand | | 175 | |
| Counter module | 2ZE2DA | 130 | Pneumatic interface | MPA-S | 238.4 | |
| | | | | VTSA/VTSA-F | 590 | |
| | | | | VTSA-F-CB without voltage zones | 560 | |
| | | | | VTSA-F-CB with safe voltage zones | 734 | |
| | | | | VTSA-F-CB with safe voltage zones and power supply for external consuming devices | 754 | |
| | | | | | | |
| | | | | | VTSA-F-CB with external power supply | 580 |

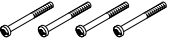
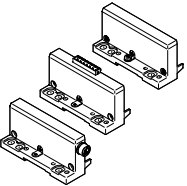
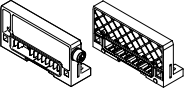
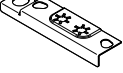
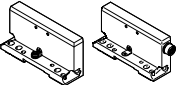
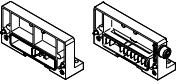

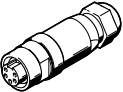
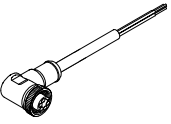

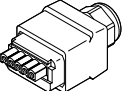
Data sheet

| Ordering data – Accessories | | Part no. | Type |
|---|---|------------------------------------|-----------------------------------|
| Designation | | | |
| Mounting | | | |
|  | Attachment for wall mounting (for long valve terminals, 10 pieces), design for plastic manifold sub-bases | 529040 | CPX-BG-RW-10x |
|  | Attachment for wall mounting, version for metal manifold sub-bases | 2 mounting brackets, 4 screws | 550217 CPX-M-BG-RW-2X |
| | | 1 mounting bracket, 2 screws | 2721419 CPX-M-BG-VT-2X |
|  | Mounting for H-rail | CPX without pneumatic components | 526032 CPX-CPA-BG-NRH |
| | | CPX-VTSA | |
| | | CPX-VTSA-F | |
| | | CPX-MPA | |
| Tie rod | | | |
|  | Tie rod CPX | Extension, 1 module | 525418 CPX-ZA-1-E |
| | | 1-module | 195718 CPX-ZA-1 |
| | | 2-module | 195720 CPX-ZA-2 |
| | | 3-module | 195722 CPX-ZA-3 |
| | | 4-module | 195724 CPX-ZA-4 |
| | | 5-module | 195726 CPX-ZA-5 |
| | | 6-module | 195728 CPX-ZA-6 |
| | | 7-module | 195730 CPX-ZA-7 |
| | | 8-module | 195732 CPX-ZA-8 |
| | | 9-module | 195734 CPX-ZA-9 |
| 10-module | 195736 CPX-ZA-10 | | |
| Plastic interlinking block | | | |
|  | Without power supply | – | 195742 CPX-GE-EV |
| | With system supply | M18 | 195746 CPX-GE-EV-S |
| | | M18, for ATEX environment | 8022170 CPX-GE-EV-S-VL |
| | | 7/8" – 4-pin | 541248 CPX-GE-EV-S-7/8-4POL |
| | | 7/8" – 5-pin | 541244 CPX-GE-EV-S-7/8-5POL |
| | | 7/8" – 5-pin, for ATEX environment | 8022172 CPX-GE-EV-S-7/8-5POL-VL |
| | With additional supply for outputs | M18 | 195744 CPX-GE-EV-Z |
| | | M18, for ATEX environment | 8022166 CPX-GE-EV-Z-VL |
| | | 7/8" – 4-pin | 541250 CPX-GE-EV-Z-7/8-4POL |
| | | 7/8" – 5-pin | 541246 CPX-GE-EV-Z-7/8-5POL |
| | With additional supply for valves | 7/8" – 5-pin, for ATEX environment | 8022173 CPX-GE-EV-Z-7/8-5POL-VL |
| | | M18 | 533577 CPX-GE-EV-V |
| M18, for ATEX environment | | 8022171 CPX-GE-EV-V-VL | |
| 7/8" – 4-pin | 541252 CPX-GE-EV-V-7/8-4POL | | |
| Interlinking block, metal | | | |
|  | Without power supply | – | 550206 CPX-M-GE-EV |
| | | For CPX-FVDA-P2 only | 567806 CPX-M-GE-EV-FVO |
| | With system supply | 7/8" – 4-pin | 568956 CPX-M-GE-EV-S-7/8-CIP-4P |
| | | 7/8" – 5-pin | 550208 CPX-M-GE-EV-S-7/8-5POL |
| | | 7/8" – 5-pin, for ATEX environment | 8022165 CPX-M-GE-EV-S-7/8-5POL-VL |
| | | M12x1, L-coded, 5-pin | 8098392 CPX-M-GE-EV-S-M12-5POL |
| | | Push-pull – 5-pin | 563057 CPX-M-GE-EV-S-PP-5POL |
| | With additional supply for outputs | 7/8" – 5-pin | 550210 CPX-M-GE-EV-Z-7/8-5POL |
| | | 7/8" – 5-pin, for ATEX environment | 8022158 CPX-M-GE-EV-Z-7/8-5POL-VL |
| | | Push-pull – 5-pin | 563058 CPX-M-GE-EV-Z-PP-5POL |
| | With system forwarding | M12x1, L-coded, 5-pin | 8098391 CPX-M-GE-EV-W-M12-5POL |

Data sheet

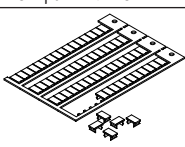
| Ordering data – Accessories | | Part no. | Type |
|---|---|-----------------------------------|-----------------------------|
| Designation | | | |
| Mounting accessories | | | |
|  | Screws for mounting the bus node/connection block on the plastic interlinking block | Bus node/metal connection block | 550218 CPX-DPT-30X32-S-4X |
| | Screws for mounting the bus node/connection block on the metal interlinking block | Bus node/plastic connection block | 550219 CPX-M-M3x22-4x |
| | | Bus node/metal connection block | 550216 CPX-M-M3x22-S-4x |
| End plates for plastic design | | | |
|  | Left-hand end plate | – | 195716 CPX-EPL-EV |
| | | With system supply | 576315 CPX-EPL-EV-S |
| | | With extension | 576314 CPX-EPL-EV-X |
|  | Right-hand end plate | – | 195714 CPX-EPR-EV |
| | | With extension | 576313 CPX-EPR-EV-X |
|  | Earthing component for right-hand/left-hand end plate | 5 pieces | 538892 CPX-EPFE-EV |
| End plates for metal design | | | |
|  | Left-hand end plate | – | 550212 CPX-M-EPL-EV |
| | | With extension | 576317 CPX-M-EPL-EV-X |
|  | Right-hand end plate | – | 550214 CPX-M-EPR-EV |
| | | With extension | 576316 CPX-M-EPR-EV-X |
| Power supply | | | |
|  | Plug socket for mains connection M18x1, straight, 4-pin | For 1.5 mm ² | 18493 NTSD-GD-9 |
| | | For 2.5 mm ² | 18526 NTSD-GD-13.5 |
| | Plug socket for mains connection M18x1, angled, 4-pin | For 1.5 mm ² | 18527 NTSD-WD-9 |
| | | For 2.5 mm ² | 533119 NTSD-WD-11 |
|  | Plug socket for mains connection 7/8", straight, 5-pin | 0.25 ... 2.0 mm ² | 543107 NECU-G78G5-C2 |
| | Plug socket for mains connection 7/8", straight, 4-pin | 0.25 ... 2.0 mm ² | 543108 NECU-G78G4-C2 |
|  | Plug socket for mains connection 7/8", angled, 5-pin – open cable end, 5-wire | 2 m | 573855 NEBU-G78W5-K-2-N-LE5 |
|  | Power supply socket M12x1, L-coded, straight | 5-pin | 8166793 NECL-L12G5-C2-Q10 |
| | Power supply plug M12x1, L-coded, straight | 5-pin | 8166791 NECL-S-L12G5-C2-Q10 |
|  | Power supply socket M12x1, L-coded, angled | 5-pin | 8166794 NECL-L12W5-C2-Q10 |
| | Power supply plug M12x1, L-coded, angled | 5-pin | 8166792 NECL-S-L12W5-C2-Q10 |
|  | Push-pull power supply socket, plug pattern PP, fulfils requirements to AIDA | 5-pin | 5195383 NECU-M-PPG5PP-C1-PN |
|  | Straight plug, spring-loaded terminal, for left-hand end plate with system supply | 7-pin | 576319 NECU-L3G7-C1 |

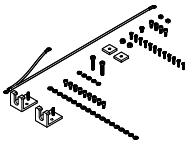
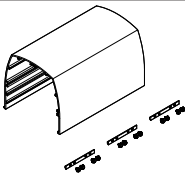
Data sheet

| Ordering data – Accessories | | Part no. | Type |
|---|--|----------|------------------------|
| Designation | | | |
| Inscription labels | | | |
|  | Inscription labels 6x10 mm, 64 pieces, in frame | 18576 | IBS-6x10 |
| Hood | | | |
|  | Mounting rail for attaching the hood | 1000 mm | 572256 CAFC-X1-S |
|  | Mounting kit for CPX hood | | 572257 CAFC-X1-BE |
|  | Hood section for CPX terminal including mounting attachments for connecting several hood sections in series. | 200 mm | 572258 CAFC-X1-GAL-200 |
| | | 300 mm | 572259 CAFC-X1-GAL-300 |
| User documentation | | | |
|  | CPX system manual | German | 526445 P.BE-CPX-SYS-DE |
| | | English | 526446 P.BE-CPX-SYS-EN |
| | | Spanish | 526447 P.BE-CPX-SYS-ES |
| | | French | 526448 P.BE-CPX-SYS-FR |
| | | Italian | 526449 P.BE-CPX-SYS-IT |

Data sheet

User documentation – General information

Comprehensive user documentation is vital for the fast and reliable use of fieldbus components.

The manuals provided by Festo contain step-by-step instructions for using the CPX terminal:

1. Installation
2. Commissioning and parameterisation
3. Diagnostics

Application-oriented explanations are provided for integrating the CPX terminal in the programming and configuration software of the various controller manufacturers.

Use the order code to select the language you want.

The manuals for the configuration you have ordered are supplied automatically.

The documents can be downloaded quickly and easily from the Festo website → www.festo.com.



Overview – User documentation

| Type | Title | Description |
|-------------------|---|--|
| Pneumatics | | |
| P.BE-VTSA-44-... | Valve terminals with VTSA and VTSA-F pneumatics | Instructions on assembly, installation, commissioning and diagnostics of the VTSA and VTSA-F pneumatic components. |
| P.BE-MPA-... | Valve terminals with MPA-S pneumatics | Instructions on assembly, installation, commissioning and diagnostics of the MPA-S pneumatic components. |
| MPAL-VI-... | Valve terminal | Instructions on assembly, installation, commissioning and diagnostics of the MPA-L pneumatic components. |

Data sheet

| Overview – User documentation | | |
|-------------------------------|--|---|
| Type | Title | Description |
| Electronics | | |
| P.BE-CPX-SYS-... | System description, installation and commissioning | Overview of the design, components and mode of operation of the CPX terminal; installation and commissioning instructions as well as basic principles of parameterisation. |
| CPX-FVDA-P2-... | PROFIsafe shut-off module | Connection technology and assembly, installation and commissioning instructions for the PROFIsafe shut-off module of the type CPX-FVDA-P2. |
| P.BE-CPX-EA-... | CPX-EA modules, digital | Connection technology and assembly, installation and commissioning instructions for digital input and output modules of type CPX-... as well as the VTSA/VTSA-F and MPA-S/L pneumatic interface. |
| P.BE-CPX-P-EA-... | Input module CPX-P-8DE-N | Connection technology and assembly, installation and commissioning instructions for the digital input module for NAMUR sensors of type CPX-P-8DE-N. |
| CPX-F8DE-P-... | Input module CPX-F8DE-N | Connection technology and assembly, installation and commissioning instructions for the PROFIsafe input module of type CPX-F8DE-P. |
| P.BE-CPX-2ZE2DA-... | I/O-module CPX-2ZE2DA | Connection technology and assembly, installation and commissioning instructions for counter modules of type CPX-2ZE2DA. |
| P.BE-CPX-AX-... | CPX-EA modules, analogue | Connection technology and assembly, installation and commissioning instructions for analogue input and output modules of type CPX-... as well as pressure sensors and proportional pressure regulators. |
| P.BE-CPX-CP-... | CPX CP interface | Instructions on assembly, installation, commissioning and diagnostics of the CP interface. |
| P.BE-CPX-CTEL-... | CPX CTEL interface | Instructions on assembly, installation, commissioning and diagnostics of the CPX CTEL master. |
| P.BE-CPX-CTEL-LK-... | Electrical interface CPX-CTEL-2 | Instructions on assembly, installation, commissioning and diagnostics for the CPX electrical interface for IO-Link. |
| CPX-CM-HPP-... | CPX axis interface | Instructions on assembly, installation, commissioning and diagnostics of the CPX axis interface (CM-HPP). |
| P.BE-CPX-CMAX-SYS-... | CPX axis controller | Instructions on assembly, installation, commissioning and diagnostics of the CPX axis controller (CMAX). |
| P.BE-CPX-CMAX-CONTROL-... | CPX axis controller | Information on control, diagnostics and parameterisation of the axis controller via the fieldbus. |
| P.BE-CPX-CMPX-SYS-... | CPX end-position controller | Instructions on assembly, installation, commissioning and diagnostics of the CPX end-position controller (CMPX). |
| P.BE-CPX-CMIX-... | CPX measuring module | Instructions on assembly, installation, commissioning and diagnostics of the CPX measuring module (CMIX). |
| P.BE-CPX-FB-... CPX-... | CPX bus node | Instructions on assembly, installation, commissioning and diagnostics of the relevant bus node. |
| CPX-(M)-FB33_35/43_45-... | CPX bus node for PROFINET | Instructions on assembly, installation, commissioning and diagnostics of the relevant bus node. |
| P.BE-CPX-CEC-... | CPX CODESYS controller (control block) | Instructions on assembly, installation, commissioning and diagnostics of the relevant control block. |

User documentation – GSD, EDS, ...

Device description files and icons are used to explain the integration of the CPX terminal in the configuration software of the various controller manufacturers.

These can be downloaded quickly and easily from www.festo.com.

Data sheet – CPX Maintenance Tool

Function

The CPX Maintenance Tool (CPX-FMT) combines service software with a connecting adapter. The service software is a tool for the design, parameterisation and online diagnostics of the CPX terminal.

The USB-to-M12 adapter features built-in galvanic isolation (between CPX and PC) and enables a PC to be connected to the diagnostic interface of the CPX terminal.

- Adapters
- Software on CD-ROM

**Application**

Only from Festo

The CPX-FMT software enables access to CPX valve terminals via Ethernet with the bus nodes EtherNet/IP (FB 36), Sercos III (FB 39) and PROFINET (FB 33, FB 34, FB 35, FB 41, FB 45). The bus nodes or control blocks can be connected directly to a PC via a USB adapter from Festo. Diagnostic data such as the error trace or module diagnostics can be read out and parameters can be modified in plain text.

The data can be used directly on a PC. There is an option, for example, to send screenshots of a configuration or the current error trace directly via e-mail. In addition, CPX configurations can also be saved and archived directly as a CPX-FMT project. Undocumented changes can subsequently be identified using the online/offline comparison function.

On-site tests such as the actuation of valves or the emulation of sensor feedback (in both cases called "forcing"), for example, can be carried out without an existing controller infrastructure.

It must be noted that with the CPX-FMT, only local parameters on the CPX valve terminal can be changed and saved. The configuration of the networks or controller software cannot be influenced.

| General technical data | | |
|--|------------------|--|
| Type | | NEFC-M12G5-0.3-U1G5 |
| System requirements | PC | IBM-compatible |
| | Drive | CD-ROM |
| | Interfaces | USB port (specification USB 1.1 or higher) |
| | Operating system | Microsoft Windows 2000 or XP |
| Function range | | <ul style="list-style-type: none"> • Configuration and parameterisation • Reading out of system, module, channel diagnostics and error trace • Saving of the configuration as a project • Integration of plug-ins/links to self-executing programs |
| Scope of delivery | | <ul style="list-style-type: none"> • Adapter, M12, 5-pin to mini USB socket • CD-ROM with installation program |
| Type of mounting | | Screw-in |
| Electrical connection | | Plug M12x1, 5-pin |
| Adapter cable composition | | 4 x 0.34 mm ² |
| Cable length | [m] | 0.3 |
| Degree of protection to EN 60529 | | IP20 |
| CE marking (see declaration of conformity) ¹⁾ | | To EU RoHS Directive |
| UKCA marking (see declaration of conformity) ¹⁾ | | To UK RoHS instructions |
| Ambient temperature | [°C] | -5 ... +50 |
| Material | Housing | ABS |
| | Cable sheath | PUR |
| | Pin contact | Gold-plated brass |
| Note on materials | | RoHS-compliant |
| PWIS conformity | | VDMA24364-B2-L |

1) Additional information: www.festo.com/catalogue/... → Support/Downloads.

Data sheet – CPX Maintenance Tool

Dimensions

Download CAD data → www.festo.com

- [1] Mini B 5P USB port
- [2] Plug M12x1, 5-pin

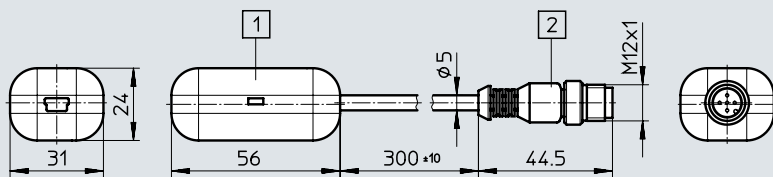

Ordering data

| Designation | Part no. | Type |
|---|----------|---------------------|
|  CPX Maintenance Tool (CPX-FMT), software and USB-to-M12 adapter | 547432 | NEFC-M12G5-0.3-U1G5 |

Data sheet – CPX-IOT gateway

- Industrial Ethernet
- TCP/IP
- OPC UA
- Web interface

Gateway for continuous transfer of operating data from connected Festo components to a central storage location (MQTT broker).

Comprehensive status information for the gateway is displayed using 7 specific LEDs.

The gateway can only be used as a combination with end plates and an interlinking block; no additional CPX modules are possible.



Application

Data collection

The CPX-IOT gateway gathers information and transfers it to a central storage location (user-specific MQTT broker).
The transfer takes place using secure protocols. The customer can only connect to the internet via a firewall.
The extent of the data gathered and transferred is determined by the evaluation software (app).

Advantages:

- The central controller of the machine or system does not require an internet connection
- Operating data are available outside the system

Prerequisites

- Connected components must have corresponding evaluation software (app)
- Internet connection
- Components to be monitored have an Industrial Ethernet interface
- MQTT broker

Information that can be evaluated (depending on the software):

- (Energy) consumption monitoring
- Preventive maintenance
- Visualisation of overall equipment effectiveness
- Identification data
- Diagnostic data
- Parameter data
- Operating status data

Interfaces

Onward communication between the gateway and the central storage location (MQTT broker) is via an Industrial Ethernet interface with M12x1 plug, D-coded to IEC 947-5-2.

The operating mode of the gateway is set using a rotary switch. This enables simple interruption of this network connection on site.

Communication with the components being monitored is also via an Industrial Ethernet interface with M12x1 plug, D-coded to IEC 947-5-2.

Both connections have auto-negotiation and crossover detection as factory settings.

Data sheet – CPX-IOT gateway

Design

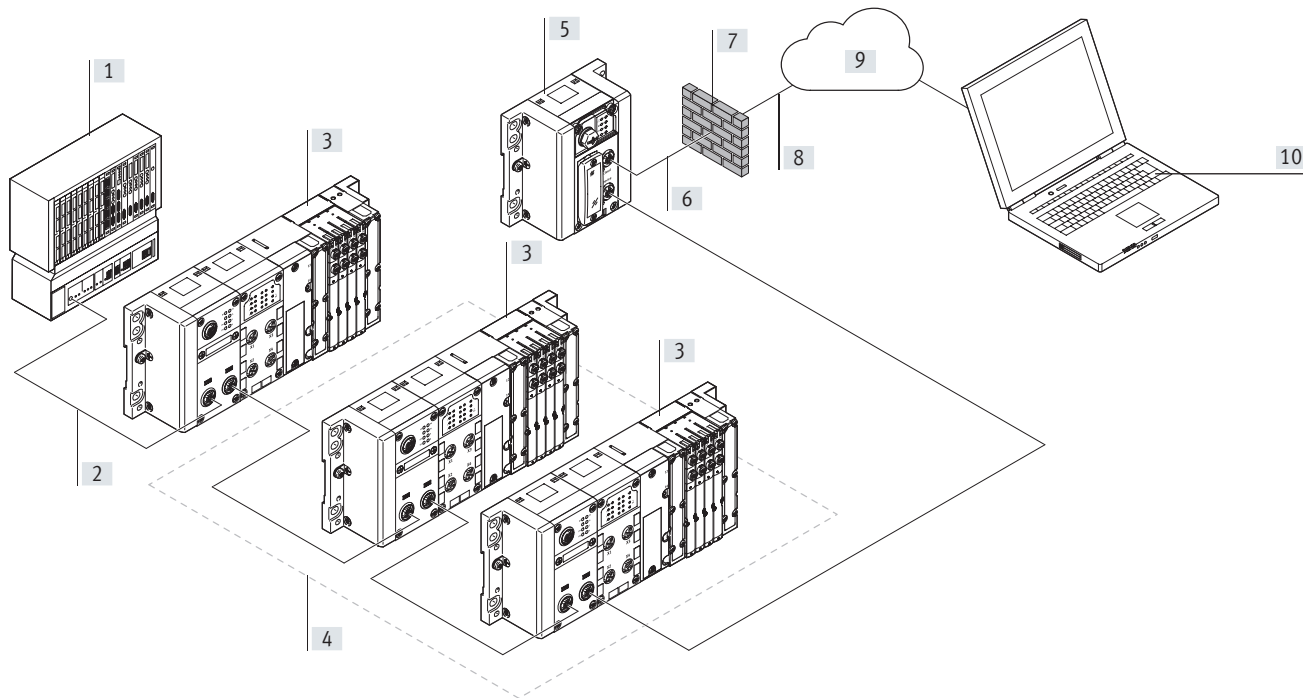

- | | | | |
|--|---|--|--|
| [1] PLC to machine/system controller (no direct internet connection) | [3] Festo components with bus connection with serial linking | [6] Internet connection | [9] Central storage location (user-specific MQTT broker) provided by Festo |
| [2] Bus system from the controller to the system parts (e.g. PROFINET) | [4] Components from which the CPX-IOT is collecting and transferring data | [7] Customer firewall or other security precautions | [10] Simple decentralised evaluation of data using adapted programs (apps) for the components that are being monitored |
| | [5] Gateway CPX-IOT | [8] Transferring data to a central storage location (MQTT broker) using secure protocols | |

Data sheet – CPX-IOT gateway

| General technical data | | |
|--|-----------------------|--|
| Type | | CPX-IOT |
| Fieldbus interface | Protocol | Ethernet OPC UA |
| | Function | Bus connection to Ethernet-based Festo devices |
| | Connection type | Socket |
| | Connection technology | M12x1, D-coded to EN 61076-2-101 |
| | Number of pins/wires | 4 |
| | Galvanic isolation | Yes |
| | Transmission rate | [Mbps] 100 |
| Ethernet interface | Protocol | TCP/IP |
| | Function | Connection to MQTT broker |
| | Connection type | Socket |
| | Connection technology | M12x1, D-coded to EN 61076-2-101 |
| | Number of pins/wires | 4 |
| | Transmission rate | [Mbps] 10 [Mbps] 100 |
| CPU data | | Dual core 533 MHz 256 MB RAM |
| Configuration support | | Integrated web server |
| Diagnostics via LED | | Modify |
| | | Module location |
| | | Network status |
| | | Network status port 1 |
| | | Network status port 2 |
| | | Power supply, electronics/sensors |
| | | Power supply load |
| | | System error |
| Control elements | | Rotary switch for setting operating mode |
| | | DIL switch for resetting to delivery status |
| IP address setting | | DHCP |
| | | Static via web server |
| Technical data – Electrics | | |
| Nominal operating voltage DC for electronics/sensors | [V DC] | 24 |
| Permissible voltage fluctuations for electronic system/sensors | [%] | ±25 |
| Power failure buffering | [ms] | 10 |
| Intrinsic current consumption at nominal operating voltage for electronic system/sensors | [mA] | Typically 80 |
| Protection against direct and indirect contact | | PELV |
| Technical data – Mechanical components | | |
| Type of mounting | | With H-rail |
| Product weight | [g] | 130 |
| Grid dimension | [mm] | 50 |
| Dimensions W x L x H | [mm] | 50 x 107 x 50 |
| Materials | | |
| Housing | | PA |
| Note on materials | | RoHS-compliant |
| PWIS conformity | | VDMA24364-B2-L |

Data sheet – CPX-IOT gateway

| Operating and environmental conditions | | |
|--|------|-----------------------------------|
| Ambient temperature | [°C] | - 5... +50 |
| Storage temperature | [°C] | - 20... +70 |
| Relative humidity | [%] | 95 |
| | | Non-condensing |
| Corrosion resistance class CRC ¹⁾ | | 0 |
| CE marking (see declaration of conformity) ³⁾ | | To EU EMC Directive ²⁾ |
| Degree of protection | | IP65 |
| | | IP67 |

1) Additional information: www.festo.com/x/topic/kbk

2) For information about the area of use, see the EC declaration of conformity at: www.festo.com/catalogue/... → Support/Downloads.

If the devices are subject to usage restrictions in residential, commercial or light-industrial environments, further measures for the reduction of the emitted interference may be necessary.

3) Additional information: www.festo.com/catalogue/... → Support/Downloads.

| Safety characteristics | |
|------------------------|--|
| Shock resistance | Shock test with severity level 1 to FN 942017-5 and EN 60068-2-27 |
| Vibration resistance | Transport application test with severity level 1 to FN 942017-4 and EN 60068-2-6 |

Connection and display components

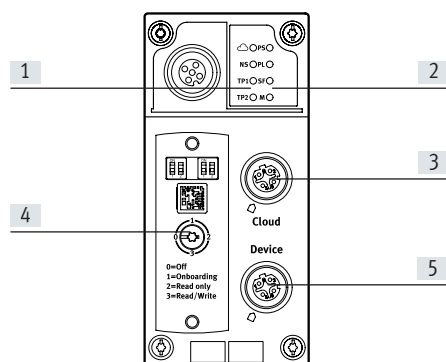

- [1] Network-specific LED displays
- [2] Gateway-specific LED displays
- [3] Connection to MQTT broker
(M12x1 socket, 4-pin, D-coded)
- [4] Transparent switch cover
- [5] Bus connection to Ethernet-based
Festo devices (M12x1 socket,
4-pin, D-coded)





| Pin allocation for MQTT broker connection and bus connection to Ethernet-based Festo devices | | | |
|--|---------|-----------|--|
| Terminal allocation | Pin | Signal | Designation |
| M12x1 socket, D-coded | | | |
| | 1 | TD+ | Transmitted data+ |
| | 2 | RD+ | Received data+ |
| | 3 | TD- | Transmitted data- |
| | 4 | RD- | Received data- |
| | Housing | Shielding | Connected to functional earth (FE) via RC link |

Data sheet – CPX-IOT gateway

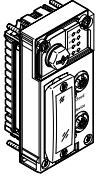
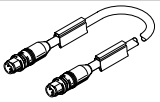

| Combinations of interlinking blocks and gateway | | |
|---|----------|---------|
| Interlinking blocks | Part no. | Gateway |
| | | CPX-IOT |
| CPX-GE-EV-S | 195746 | ■ |
| CPX-GE-EV-S-VL | 8022170 | - |
| CPX-GE-EV-S-7/8-4POL | 541248 | - |
| CPX-GE-EV-S-7/8-5POL | 541244 | ■ |
| CPX-GE-EV-S-7/8-5POL-VL | 8022172 | - |
| CPX-M-GE-EV-S-7/8-CIP-4P | 568956 | - |
| CPX-M-GE-EV-S-7/8-5POL | 550208 | - |
| CPX-M-GE-EV-S-7/8-5POL-VL | 8022165 | - |
| CPX-M-GE-EV-S-PP-5POL | 563057 | - |
| CPX-GE-EV | 195742 | ■ |
| CPX-M-GE-EV | 550206 | - |
| CPX-M-GE-EV-FVO | 567806 | - |
| CPX-GE-EV-Z | 195744 | - |
| CPX-GE-EV-Z-VL | 8022166 | - |
| CPX-GE-EV-Z-7/8-4POL | 541250 | - |
| CPX-GE-EV-Z-7/8-5POL | 541246 | - |
| CPX-GE-EV-Z-7/8-5POL-VL | 8022173 | - |
| CPX-M-GE-EV-Z-7/8-5POL | 550210 | - |
| CPX-M-GE-EV-Z-7/8-5POL-VL | 8022158 | - |
| CPX-M-GE-EV-S-M12-5POL | 8098392 | - |
| CPX-M-GE-EV-Z-PP-5POL | 563058 | - |
| CPX-GE-EV-V | 533577 | - |
| CPX-GE-EV-V-VL | 8022171 | - |
| CPX-GE-EV-V-7/8-4POL | 541252 | - |
| CPX-M-GE-EV-W-M12-5POL | 8098391 | - |

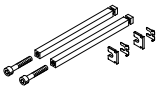
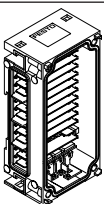
| Combinations of end plates and gateway | | |
|--|----------|---------|
| End plates | Part no. | Gateway |
| | | CPX-IOT |
| CPX-EPL-EV | 195716 | ■ |
| CPX-EPL-EV-S | 576315 | ■ |
| CPX-EPL-EV-X | 576314 | - |
| CPX-EPR-EV | 195714 | ■ |
| CPX-EPR-EV-X | 576313 | - |

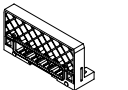
Data sheet – CPX-IOT gateway

| Ordering data | | | | Part no. | Type |
|---|--|---|------------------------|----------|------------------------------|
| Designation | | | | | |
| Gateway | | | | | |
|  | | | | 8069773 | CPX-IOT |
| Bus connection | | | | | |
|  | Connecting cable, straight plug, M12x1, 4-pin, D-coded | Straight plug, M12x1, 4-pin, D-coded | 0.5 m | 8040446 | NEBC-D12G4-ES-0.5-S-D12G4-ET |
| | | | 1 m | 8040447 | NEBC-D12G4-ES-1-S-D12G4-ET |
| | | | 3 m | 8040448 | NEBC-D12G4-ES-3-S-D12G4-ET |
| | | | 5 m | 8040449 | NEBC-D12G4-ES-5-S-D12G4-ET |
| | | | 10 m | 8040450 | NEBC-D12G4-ES-10-S-D12G4-ET |
| | | Straight plug, RJ45, 8-pin | 1 m | 8040451 | NEBC-D12G4-ES-1-S-R3G4-ET |
| | | | 3 m | 8040452 | NEBC-D12G4-ES-3-S-R3G4-ET |
| | | | 5 m | 8040453 | NEBC-D12G4-ES-5-S-R3G4-ET |
| | | Open end, 4-wire | 10 m | 8040454 | NEBC-D12G4-ES-10-S-R3G4-ET |
| 5 m | 8040456 | | NEBC-LE4-ES-5-D12G4-ET | | |
|  | Cover cap for sealing unused bus connections (10 pieces) | | | 165592 | ISK-M12 |
| Tie rod | | | | | |
|  | Tie rod CPX | Tie rod CPX | 1-module | 195718 | CPX-ZA-1 |
| Interlinking block | | | | | |
|  | Without power supply | | – | 195742 | CPX-GE-EV |
| | With system supply | | M18 | 195746 | CPX-GE-EV-S |
| | | | 7/8" – 5-pin | 541244 | CPX-GE-EV-S-7/8-5POL |
| End plates | | | | | |
|  | Left-hand end plate | Without supply | | 195716 | CPX-EPL-EV |
| | | With system supply | | 576315 | CPX-EPL-EV-S |
|  | Right-hand end plate | – | | 195714 | CPX-EPR-EV |
|  | | Earthing component for right-hand/left-hand end plate | | 5 pieces | 538892 |

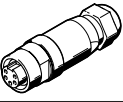
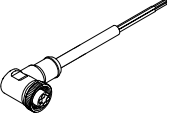
Data sheet – CPX-IOT gateway

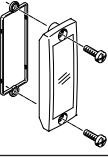
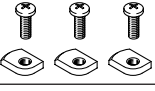
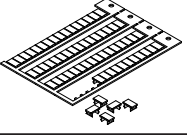
| Ordering data | | | | Part no. | Type |
|--|---|----------|------------------------------|----------|----------------------|
| Designation | | | | | |
| Power supply | | | | | |
|  | Plug socket for mains connection M18x1, 4-pin | Straight | For 1.5 mm ² | 18493 | NTSD-GD-9 |
| | | | For 2.5 mm ² | 18526 | NTSD-GD-13.5 |
| | | Angled | For 1.5 mm ² | 18527 | NTSD-WD-9 |
| | | | For 2.5 mm ² | 533119 | NTSD-WD-11 |
|  | Plug socket for mains connection 7/8", straight, 5-pin | | 0.25 ... 2.0 mm ² | 543107 | NECU-G78G5-C2 |
|  | Plug socket for mains connection 7/8", angled, 5-pin – open cable end, 5-wire | | 2 m | 573855 | NEBU-G78W5-K-2-N-LE5 |
|  | Straight plug, spring-loaded terminal, for left-hand end plate with system supply | | 7-pin | 576319 | NECU-L3G7-C1 |
| Cover | | | | | |
|  | Inspection cover, transparent | | | 533334 | AK-SUB-9/15-B |
| Mounting | | | | | |
|  | Mounting for H-rail | | | 526032 | CPX-CPA-BG-NRH |
| Inscription labels | | | | | |
|  | Inscription labels 6x10 mm, 64 pieces, in frame | | | 18576 | IBS-6x10 |

Data sheet – CODESYS controller

- Industrial Ethernet
- TCP/IP
- EasyIP
- Web interface
- Email
- Data transfer

The CODESYS controller is a modern control system for CPX terminals that enables programming with CODESYS to IEC 61131-3.

The power supply to and communication with other modules takes place via the interlinking block.

In addition to network connections, LEDs are also provided for the bus status, operating status of the PLC and CPX peripherals information, as are switching elements and a diagnostic interface for CPX-FMT.

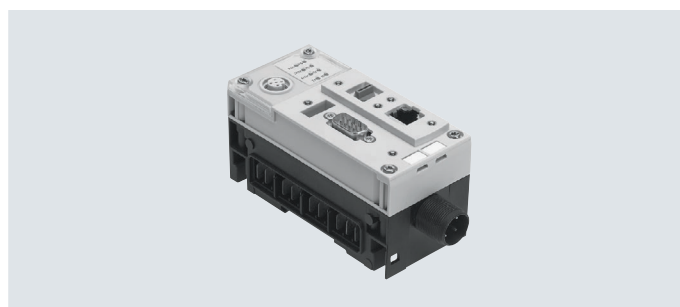

| Application | | | |
|--|---|--|---|
| Bus connection | | Communication protocols | Operating modes |
| The CPX-CEC is a remote controller that can be connected to a higher-order PLC via the bus nodes of the CPX terminal or via Ethernet. | At the same time, it is possible to operate the CPX-CEC as a compact stand-alone controller directly on the machine. | <ul style="list-style-type: none"> • Fieldbus via CPX bus nodes • Modbus/TCP • EasyIP | <ul style="list-style-type: none"> • Stand-alone • Remote controller, fieldbus • Remote controller, Ethernet |
| Setting options | | | |
| The CPX-CEC has the following interfaces for monitoring, programming and commissioning: | <ul style="list-style-type: none"> • For the CPX-FMT • Ethernet interface for IT applications • Remote diagnostics | The operating mode and fieldbus protocol are set using the DIL switch on the CPX-CEC. | The integrated web server offers a convenient means of querying data saved in the CPX-CEC. |
| Features | | | |
| <ul style="list-style-type: none"> • Easy control of valve terminal configurations with MPA, VTSA • Diagnostics with flexible monitoring options for pressure, flow rate, cylinder operating time, air consumption | <ul style="list-style-type: none"> • Activation of decentralised installation systems on the basis of CPI control of applications in proportional pneumatics • AS-Interface control via gateway | <ul style="list-style-type: none"> • Connection to all fieldbuses as a remote controller and for preprocessing • Control of electric actuators as individual axes via CANopen (CPX-CEC-C1/-M1) | <ul style="list-style-type: none"> • Early warnings and visualisation options • Servo-pneumatic applications |

Data sheet – CODESYS controller

| General technical data | | |
|---|---------------------------|---|
| Protocol | | CODESYS Level 2 |
| | | EasyIP |
| | | Modbus TCP |
| | | TCP/IP |
| Processing time | | Approx. 200 µs/1 k instructions |
| Programming software | | CODESYS provided by Festo |
| Programming language | | To IEC 61131-3 |
| | | Sequential function chart (SFC) |
| | | Instruction list (IL) |
| | | Function chart (FCH), additional continuous function chart (CFC) |
| | | Ladder diagram (LD) |
| Programming | Operating language | German, English |
| | Support for file handling | Yes |
| Device-specific diagnostics | | Diagnostic memory |
| | | Channel and module-oriented diagnostics |
| | | Undervoltage/short-circuit modules |
| LED displays | Bus-specific | TP: Link/traffic |
| | Product-specific | RUN: PLC status |
| | | STOP: PLC status |
| | | ERR: PLC runtime error |
| | | PS: Electronics supply, sensor supply |
| | | PL: Load supply |
| | | SF: System fault |
| | | M: Modify/forcing active |
| IP address setting | | DHCP |
| | | Via CODESYS |
| | | Via MMI |
| Function blocks | | CPX diagnostic status, copy CPX diagnostic trace, read CPX module diagnostics, and more |
| Dimensions (including interlinking block) W x L x H | [mm] | 50 x 107 x 55 |

| Materials | | |
|-------------------|--|----------------|
| Housing | | PA-reinforced |
| | | PC |
| Note on materials | | RoHS-compliant |
| PWIS conformity | | VDMA24364-B2-L |

| Operating and environmental conditions | | |
|--|------|--------------------|
| Ambient temperature | [°C] | -5 ... +50 |
| Storage temperature | [°C] | -20 ... +70 |
| Relative humidity | [%] | 95, non-condensing |
| Corrosion resistance class CRC ¹⁾ | | 2 |

1) Additional information: www.festo.com/x/topic/kbk

| Electrical data | | |
|--|---------------------------|----------------------|
| Nominal operating voltage | [V DC] | 24 |
| Load voltage | Nominal operating voltage | [V DC] 24 |
| | With pneumatics type VTSA | [V DC] 21.6 ... 26.4 |
| | With pneumatics type MPA | [V DC] 18 ... 30 |
| | Without pneumatics | [V DC] 18 ... 30 |
| Power failure buffering | [ms] | 10 |
| Intrinsic current consumption at nominal operating voltage | [mA] | Typically 85 |
| Degree of protection to EN 60529 | | IP65, IP67 |

Data sheet – CODESYS controller

| Technical data | | | | CPX-CEC-C1 | CPX-CEC-C1-V3 | CPX-CEC-M1-V3 |
|------------------------------|--|--------|--------------------------------------|--------------------------|--|---------------|
| Type | | | | | | |
| Additional functions | | | Motion functions for electric drives | | SoftMotion functions for electric drives | |
| CPU data | Flash | [MB] | 32 | 32 | 32 | |
| | RAM | [MB] | 32 | 256 | 256 | |
| | Processor | [MHz] | 400 | 800 | 800 | |
| Control interface | | | CAN bus | | CAN bus | |
| Parameterisation | | | CODESYS V2.3 | | CODESYS V3 | |
| Configuration support | | | CODESYS V2.3 | | CODESYS V3 | |
| Program memory, user program | | | [MB] | 4 | 16 | 16 |
| Flags | | | CODESYS variable concept | | | |
| | Remanent data | [kB] | 30 | 28 | 28 | |
| | Global data memory | [MB] | 8 | – | – | |
| Control elements | | | DIL switch for CAN termination | | | |
| | | | Rotary switch for RUN/STOP | | | |
| Total number of axes | | | 31 | 127 | 31 | |
| Ethernet | Number | | 1 | | | |
| | Connection technology | | RJ45 socket, 8-pin | | | |
| | Data transmission speed | [Mbps] | 10/100 | | | |
| | Supported protocols | | TCP/IP, EasyIP, Modbus TCP | | | |
| Fieldbus interface | Number | | 1 | | | |
| | Connection technology | | Sub-D plug, 9-pin | | | |
| | Data transmission speed, can be set via software | [kbps] | 125, 250, 500, 800, 1000 | 125, 250, 500, 800, 1000 | 125, 250, 500, 800, 1000 | |
| | Supported protocols | | CAN bus | | | |
| | Galvanic isolation | | Yes | | | |
| | | | | | | |

| Technical data | | | | CPX-CEC | CPX-CEC-S1-V3 |
|------------------------------|-------------------------|--------|------------------------------|---------|---------------|
| Type | | | | | |
| CPU data | Flash | [MB] | 32 | 32 | |
| | RAM | [MB] | 32 | 256 | |
| | Processor | [MHz] | 400 | 800 | |
| Parameterisation | | | CODESYS V2.3 | | CODESYS V3 |
| Configuration support | | | CODESYS V2.3 | | CODESYS V3 |
| Additional functions | | | Diagnostic functions | | |
| | | | RS232 communication function | | |
| Program memory, user program | | | [MB] | 4 | 16 |
| Flags | | | CODESYS variable concept | | |
| | Remanent data | [kB] | 30 | 28 | |
| | Global data memory | [MB] | 8 | – | |
| Control elements | | | Rotary switch for RUN/STOP | | |
| Ethernet | Number | | 1 | | |
| | Connection technology | | RJ45 socket, 8-pin | | |
| | Data transmission speed | [Mbps] | 10/100 | | |
| | Supported protocols | | TCP/IP, EasyIP, Modbus TCP | | |
| Data interface | Number | | 1 | | |
| | Connection technology | | Sub-D socket, 9-pin | | |
| | Data transmission speed | [kbps] | 9.6 ... 230.4 | | |
| | Supported protocols | | RS232 interface | | |
| | Max. cable length | [m] | – | 30 | |
| | Galvanic isolation | | Yes | | |

Data sheet – CODESYS controller

Connection and display elements CPX-CEC-C1/-M1

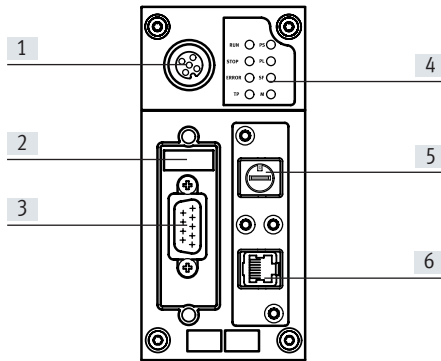

- [1] CPX-FMT connection
- [2] DIL switch
- [3] Fieldbus interface
(Sub-D plug, 9-pin)
- [4] Status LEDs, bus-specific and
product-specific
- [5] RUN/STOP rotary switch
- [6] Ethernet interface (RJ45 socket,
8-pin)

Pin allocation – CPX-CEC-C1/-M1

| | Pin | Signal | Meaning |
|---------------------------------------|-----------|--------------------------------------|-------------------------------------|
| Fieldbus interface, Sub-D plug | | | |
| | 1 | n.c. | Not connected |
| | 2 | CAN_L | CAN low |
| | 3 | CAN_GND | CAN ground |
| | 4 | n.c. | Not connected |
| | 5 | CAN_SHLD | Connection to functional earth FE |
| | 6 | CAN_GND | CAN ground (optional) ¹⁾ |
| | 7 | CAN_H | CAN high |
| | 8 | n.c. | Not connected |
| | 9 | n.c. | Not connected |
| Housing | Shielding | Plug housing must be connected to FE | |
| Ethernet interface, RJ45 plug | | | |
| | 1 | TD+ | Transmitted data+ |
| | 2 | TD- | Transmitted data- |
| | 3 | RD+ | Received data+ |
| | 4 | n.c. | Not connected |
| | 5 | n.c. | Not connected |
| | 6 | RD- | Received data- |
| | 7 | n.c. | Not connected |
| | 8 | n.c. | Not connected |
| Housing | Shielding | Shielding | |

1) If a servo drive is connected to an external power supply, CAN ground (optional), pin 6, cannot be used on the CPX-CEC-C1/-M1.

Data sheet – CODESYS controller

Connection and display elements CPX-CEC/CPX-CEC-S1-V3

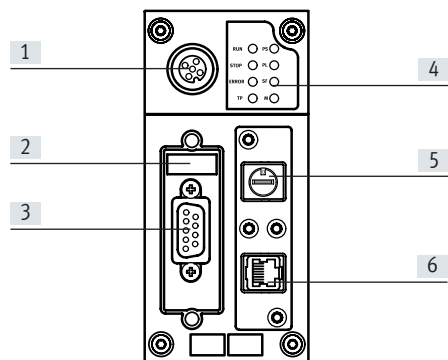







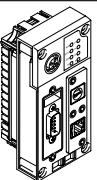
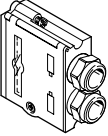

- [1] CPX-FMT connection
- [2] DIL switch
- [3] RS232 interface
(Sub-D socket, 9-pin)
- [4] Status LEDs, bus-specific and
product-specific
- [5] RUN/STOP rotary switch
- [6] Ethernet interface (RJ45 socket,
8-pin)

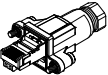

Pin allocation – CPX-CEC/CPX-CEC-S1-V3

| | Pin | Signal | Meaning |
|---------------------------------------|-----------|-----------|--------------------------------|
| RS 232 interface, Sub-D socket | | | |
| | 1 | n.c. | Not connected |
| | 2 | RxD | Received data |
| | 3 | TxD | Transmitted data |
| | 4 | n.c. | Not connected |
| | 5 | GND | Data reference potential |
| | 6 | n.c. | Not connected |
| | 7 | n.c. | Not connected |
| | 8 | n.c. | Not connected |
| | 9 | n.c. | Not connected |
| | Shielding | Shielding | Connection to functional earth |
| Ethernet interface, RJ45 plug | | | |
| | 1 | TD+ | Transmitted data+ |
| | 2 | TD- | Transmitted data- |
| | 3 | RD+ | Received data+ |
| | 4 | n.c. | Not connected |
| | 5 | n.c. | Not connected |
| | 6 | RD- | Received data- |
| | 7 | n.c. | Not connected |
| | 8 | n.c. | Not connected |
| | Housing | Shielding | Shielding |

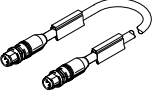
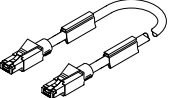
Data sheet – CODESYS controller

| Ordering data | | | | | Part no. | Type |
|--|--|--------------------------------------|----------------------------------|-------|----------|----------------------------|
| Designation | | | | | | |
| Control block | | | | | | |
|  | Motion functions for electric drives | | CODESYS V2.3 | 155 g | 567347 | CPX-CEC-C1 |
| | | | CODESYS V3 | 135 g | 3473128 | CPX-CEC-C1-V3 |
| | SoftMotion functions for electric drives | | CODESYS V3 | 135 g | 3472765 | CPX-CEC-M1-V3 |
| | RS232 communication function | | CODESYS V2.3 | 155 g | 567346 | CPX-CEC |
| | | | CODESYS V3 | 135 g | 3472425 | CPX-CEC-S1-V3 |
| Fieldbus interface | | | | | | |
|  | Sub-D plug, 9-pin, for CANopen | | | | 532219 | FBS-SUB-9-BU-2x5POL-B |
|  | Micro style bus connection, 2xM12 for DeviceNet/CANopen | | | | 525632 | FBA-2-M12-5POL |
|  | Socket for micro style connection, M12 | | | | 18324 | FBSD-GD-9-5POL |
|  | Plug for micro style connection, M12 | | | | 175380 | FBS-M12-5GS-PG9 |
|  | Open style bus connection for 5-pin terminal strip for DeviceNet/CANopen | | | | 525634 | FBA-1-SL-5POL |
|  | Terminal strip for open style connection, 5-pin | | | | 525635 | FBSD-KL-2x5POL |
| Ethernet interface | | | | | | |
|  | RJ45 plug | | Degree of protection IP 65, IP67 | | 534494 | FBS-RJ45-8-GS |
|  | Cover for RJ45 connection | | Degree of protection IP 65, IP67 | | 534496 | AK-RJ45 |
|  | Straight plug, RJ45, 8-pin | Straight plug, M12x1, 4-pin, D-coded | Degree of protection IP20 | 1 m | 8040451 | NEBC-D12G4-ES-1-S-R3G4-ET |
| | | | | 3 m | 8040452 | NEBC-D12G4-ES-3-S-R3G4-ET |
| | | | | 5 m | 8040453 | NEBC-D12G4-ES-5-S-R3G4-ET |
| | | | | 10 m | 8040454 | NEBC-D12G4-ES-10-S-R3G4-ET |
|  | Straight plug, RJ45, 8-pin | Straight plug, RJ45, 8-pin | Degree of protection IP20 | 1 m | 8040455 | NEBC-R3G4-ES-1-S-R3G4-ET |

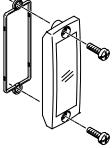
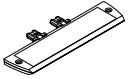
Data sheet – CODESYS controller

| Ordering data | | Part no. | Type |
|---|---|----------|------------------------|
| Designation | | | |
| Covers and attachments | | | |
|  | Inspection cover, transparent, for Sub-D connection | 533334 | AK-SUB-9/15-B |
|  | Inscription label holder for connection block | 536593 | CPX-ST-1 |
| User documentation | | | |
|  | Manual for control block CPX-CEC | German | 569121 P.BE-CPX-CEC-DE |
| | | English | 569122 P.BE-CPX-CEC-EN |

Data sheet – DeviceNet bus node



Bus node for handling communication between the electrical terminal CPX and a DeviceNet network.

The bus node is provided with system supply via the interlinking block and processes communication with the I/O modules.

The status of the CPX terminal is displayed as a common message via 4 CPX-specific LEDs.

The fieldbus communication status is displayed via the three DeviceNet-specific LEDs.

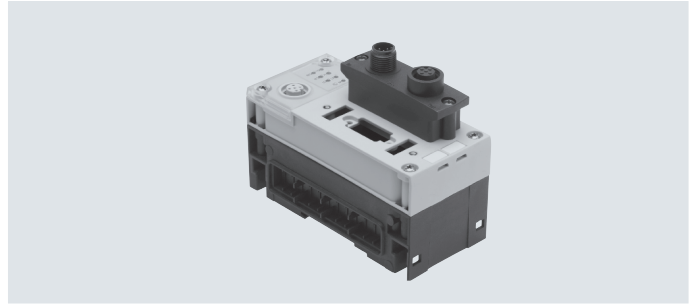

Application

Bus connection

The bus connection can be selected when ordering, either micro style as 2xM12 round plugs or open style as a terminal strip with IP20 protection.

Both connection types have the function of an integrated T-distributor with incoming and outgoing bus line.

DeviceNet implementation

The CPX-FB11 operates with the Predefined Master/Slave Connection Set as a Group 2 Only Server.

The polled I/O, change of state or cyclic method is used for the transmission of cyclic I/O data. The type of transmission can be selected in the network configuration.

The device diagnostics for all bus nodes CPX-FB11 is effectively gathered via strobed I/O and displayed in the input table of the controller.

In addition to cyclic data transmission, acyclic communication is supported through explicit messaging, which enables detailed device diagnostics and parameterisation.

A comprehensive EDS file supports the display of acyclic data. It is also possible to display system information and assign parameters while the controller is running via the user program or the configuration software.

An example of this is access to the integrated diagnostic memory function, i.e. storage of the last 40 errors with timestamp, module, channel and error type.

With its address capacity of 64 byte inputs and 64 byte outputs, the CPX-FB11 supports any configuration of I/O modules, including pneumatic interface.

Points to note in connection with CPX-CEC

When a bus node is combined with a control block (CPX-CEC, in the fieldbus remote controller operating mode), the connected I/Os and/or valves, sensors and actuators are controlled via the CPX control block.

In this case, the bus node only provides the communication interface to the PLC.

Communication between the control block and CPX bus node takes place by interlinking the CPX modules and takes

up the following address capacity in the CPX system:

- 8 byte outputs
- 8 byte inputs

The following address capacity remains in the control block or CPX system for activating the peripherals:

- 56 byte inputs
- 56 byte outputs

Data sheet – DeviceNet bus node

| General technical data | | | |
|---|---|---------------------------------|-------------|
| Type | CPX-FB11 | | |
| Fieldbus interface | Either <ul style="list-style-type: none"> • Micro style bus connection: 2xM12 with degree of protection IP65, IP67 • Open style bus connection: 5-pin terminal strip, IP20 | | |
| Baud rate | [kbps] | 125, 250, 500 | |
| Addressing range | 0 ... 63 Set using DIL switch | | |
| Product | Type | Communication adapter (12 dec.) | |
| | Code | 4554 dec. | |
| Types of communication | Polled I/O, change of state/cyclic, strobed I/O and explicit messaging | | |
| Configuration support | EDS file and bitmaps | | |
| Max. address capacity | Inputs | [byte] | 64 |
| | Outputs | [byte] | 64 |
| LED displays (bus-specific) | MS = Module status NS = Network status IO = I/O status | | |
| Device-specific diagnostics | Module and channel-oriented diagnostics via manufacturer-specific diagnostic object | | |
| Parameterisation | <ul style="list-style-type: none"> • Module and system parameterisation via configuration interface in plain text (EDS) • Online in run or program mode | | |
| Additional functions | <ul style="list-style-type: none"> • Storage of the last 40 errors with timestamp (access via EDS) • 8-bit system status in image table for inputs • 2-byte inputs and 2-byte outputs, system diagnostics in process image | | |
| Control elements | DIL switch | | |
| Operating voltage | Nominal value | [V DC] | 24 |
| | Permissible range | [V DC] | 18 ... 30 |
| | Power failure buffering | [ms] | 10 |
| Current consumption | [mA] | Typically 200 | |
| Degree of protection to EN 60529 | IP65, IP67 | | |
| Temperature range | Operation | [°C] | -5 ... +50 |
| | Storage/transport | [°C] | -20 ... +70 |
| Materials | Reinforced PA, PC | | |
| PWIS conformity | VDMA24364-B2-L | | |
| Grid dimension | [mm] | 50 | |
| Dimensions (including interlinking block) W x L x H | [mm] | 50 x 107 x 50 | |
| Product weight | [g] | 120 | |

 **Note**

Please observe the general limits and guidelines for the system when configuring the electrical modules.

Data sheet – DeviceNet bus node

Connection and display components

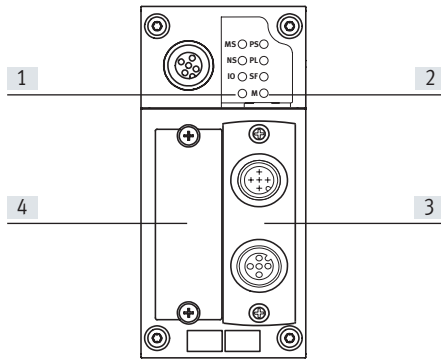





- [1] Bus-specific LEDs
- [2] CPX-specific status LEDs
- [3] Selectable fieldbus interface
 - Micro style
 - Open style
- [4] DIL switch cover

Pin allocation for the DeviceNet interface

| Terminal allocation | Pin | Signal-specific wire colour ¹⁾ | Signal | Designation |
|--|-----|---|-------------|--------------------------------|
| Sub-D plug | | | | |
| | 1 | – | n.c. | Not connected |
| | 2 | Blue | CAN_L | Received/transmitted data low |
| | 3 | Black | 0 V bus | 0 V CAN interface |
| | 4 | – | n.c. | Not connected |
| | 5 | Bare | Shielding | Connection to housing |
| | 6 | – | n.c. | Not connected |
| | 7 | White | CAN_H | Received/transmitted data high |
| | 8 | – | n.c. | Not connected |
| | 9 | Red | 24 V DC bus | 24 V DC supply CAN interface |
| Micro style bus connection (M12), incoming/outgoing | | | | |
| Incoming | | | | |
| | 1 | Bare | Shielding | Connection to housing |
| | 2 | Red | 24 V DC bus | 24 V DC supply CAN interface |
| | 3 | Black | 0 V bus | 0 V CAN interface |
| | 4 | White | CAN_H | Received/transmitted data high |
| | 5 | Blue | CAN_L | Received/transmitted data low |
| Outgoing | | | | |
| | 1 | Bare | Shielding | Connection to housing |
| | 2 | Red | 24 V DC bus | 24 V DC supply CAN interface |
| | 3 | Black | 0 V bus | 0 V CAN interface |
| | 4 | White | CAN_H | Received/transmitted data high |
| | 5 | Blue | CAN_L | Received/transmitted data low |
| Open style bus connection | | | | |
| | 1 | Black | 0 V bus | 0 V CAN interface |
| | 2 | Blue | CAN_L | Received/transmitted data low |
| | 3 | Bare | Shielding | Connection to housing |
| | 4 | White | CAN_H | Received/transmitted data high |
| | 5 | Red | 24 V DC bus | 24 V DC supply CAN interface |
| 7/8" bus connection | | | | |
| | 1 | Black | Shielding | Connection to housing |
| | 2 | Blue | 24 V DC | 24 V DC supply CAN interface |
| | 3 | Bare | 0 V | 0 V CAN interface |
| | 4 | White | CAN_H | Received/transmitted data high |
| | 5 | Red | CAN_L | Received/transmitted data low |

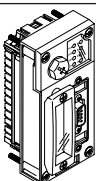
1) Typical of DeviceNet connecting cables

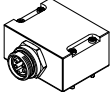
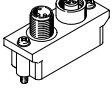
Data sheet – DeviceNet bus node

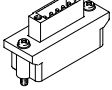
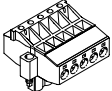
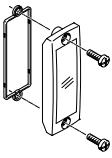
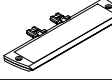
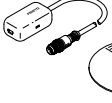
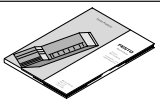
| Ordering data | | Part no. | Type | |
|---|--|----------|-----------------------|------------------|
| Designation | | | | |
| Bus node | | | | |
|  | DeviceNet bus node | 526172 | CPX-FB11 | |
| Bus connection | | | | |
|  | Sub-D plug | 532219 | FBS-SUB-9-BU-2x5POL-B | |
|  | Connection block, 9-pin Sub-D socket, 5-pin 7/8" plug | 571052 | CPX-AB-1-7/8-DN | |
|  | Micro style bus connection, 2xM12 | 525632 | FBA-2-M12-5POL | |
|  | Socket for micro style connection, M12 | 18324 | FBSD-GD-9-5POL | |
| | Plug for micro style connection, M12 | 175380 | FBS-M12-5GS-PG9 | |
|  | Open style bus connection for 5-pin terminal strip | 525634 | FBA-1-SL-5POL | |
|  | Terminal strip for open style connection, 5-pin | 525635 | FBSD-KL-2x5POL | |
|  | Inspection cover, transparent | 533334 | AK-SUB-9/15-B | |
|  | Inscription label holder for connection block | 536593 | CPX-ST-1 | |
|  | 5-pin M12 to mini USB socket adapter and controller software | 547432 | NEFC-M12G5-0.3-U1G5 | |
| User documentation | | | | |
|  | User documentation for bus node CPX-FB11 | German | 526421 | P.BE-CPX-FB11-DE |
| | | English | 526422 | P.BE-CPX-FB11-EN |
| | | Spanish | 526423 | P.BE-CPX-FB11-ES |
| | | French | 526424 | P.BE-CPX-FB11-FR |
| | | Italian | 526425 | P.BE-CPX-FB11-IT |

Data sheet – PROFIBUS bus node



Bus node for handling communication between the electrical terminal CPX and a higher-order master via PROFIBUS DP.

The bus node is provided with system supply via the interlinking block and processes communication with the I/O modules.

The status of the CPX terminal is displayed as a common message via 4 CPX-specific LEDs.

The fieldbus communication status is displayed via the PROFIBUS-specific error LED.

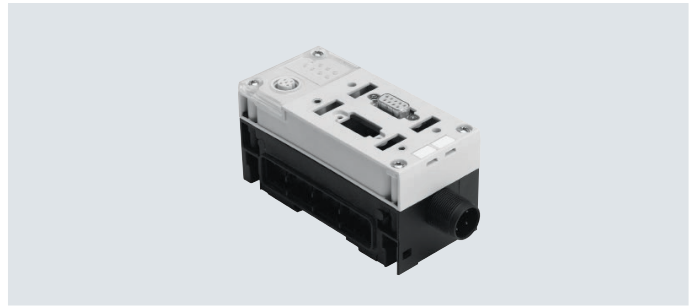

Application

Bus connection

The bus connection is established via a 9-pin Sub-D socket with a typical PROFIBUS allocation (to EN 50170).

The bus connector plug (with degree of protection IP65/IP67 from Festo or degree of protection IP20 from other manufacturers) facilitates the connection of an incoming and an outgoing bus cable.

An active bus terminal can be connected using the DIL switch integrated in the plug.

The Sub-D interface is designed for controlling network components with a fibre-optic cable connection.

PROFIBUS DP implementation

The CPX-FB13 supports the PROFIBUS DP protocol to EN 50170 Volume 2 for cyclic I/O exchange, parameterisation and diagnostic functions (DPV0).

In addition to DPV0, acyclic communication to the advanced specification DPV1 is supported. DPV1 provides acyclic access to advanced system information and allows parameterisation while the controller is running via the user program.

An example of this is access to the integrated diagnostic memory function, i.e. storage of the last 40 errors with timestamp, module, channel and error type.

With its address capacity of 64 byte inputs and 64 byte outputs, the CPX-FB13 supports any configuration of I/O modules, including pneumatic interface.

Points to note in connection with CPX-CEC

When a bus node is combined with a control block (CPX-CEC, in the fieldbus remote controller operating mode), the connected I/Os and/or valves, sensors and actuators are controlled via the CPX control block.

In this case, the bus node only provides the communication interface to the PLC.

Communication between the control block and CPX bus node takes place by interlinking the CPX modules and takes up the following address capacity in the CPX system:

- 8 byte outputs
 - 8 byte inputs
- The following address capacity remains in the control block or CPX system for activating the peripherals:
- 56 byte inputs
 - 56 byte outputs

Data sheet – PROFIBUS bus node

| General technical data | | | |
|---|--|---------------|---------------|
| Type | CPX-FB13 | | |
| Fieldbus interface | Sub-D socket, 9-pin (EN 50170) Galvanically isolated 5 V | | |
| Baud rate | [Mbps] | 0.0096 ... 12 | |
| Addressing range | 1 ... 125 Set using DIL switch | | |
| Product family | 4: Valves | | |
| ID number | 0x059E | | |
| Types of communication | DPV0: Cyclic communication DPV1: Acyclic communication | | |
| Configuration support | GSD file and bitmaps | | |
| Max. address capacity | Inputs | [byte] | 64 |
| | Outputs | [byte] | 64 |
| LED displays (bus-specific) | BF: Bus fault | | |
| Device-specific diagnostics | Identifier and channel-oriented diagnostics to EN 50170 (PROFIBUS standard) | | |
| Parameterisation | <ul style="list-style-type: none"> Start-up parameterisation via configuration interface in plain text (GSD) Acyclic parameterisation via DPV1 | | |
| Additional functions | <ul style="list-style-type: none"> Storage of the last 40 errors with timestamp (access via DPV1) 8-bit system status in image table for inputs 2-byte inputs and 2-byte outputs, system diagnostics in process image | | |
| Control elements | DIL switch | | |
| Operating voltage | Nominal value | [V DC] | 24 |
| | Permissible range | [V DC] | 18 ... 30 |
| | Power failure buffering | [ms] | 10 |
| Current consumption | | | [mA] |
| | | | Typically 200 |
| Degree of protection to EN 60529 | IP65, IP67 | | |
| Temperature range | Operation | [°C] | -5 ... +50 |
| | Storage/transport | [°C] | -20 ... +70 |
| Materials | Reinforced PA, PC | | |
| PWIS conformity | VDMA24364-B2-L | | |
| Grid dimension | | | [mm] |
| | | | 50 |
| Dimensions (including interlinking block) W x L x H | | | [mm] |
| | | | 50 x 107 x 50 |
| Product weight | | | [g] |
| | | | 115 |

 **Note**

Please observe the general limits and guidelines for the system when configuring the electrical modules.

Data sheet – PROFIBUS bus node

Connection and display components

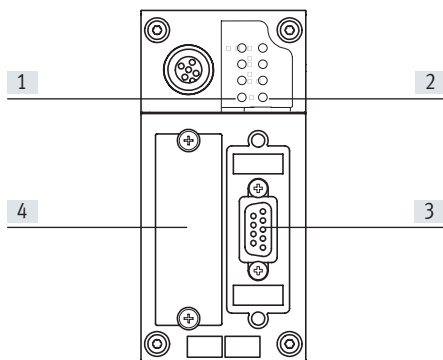

- [1] Bus status LEDs/bus fault
- [2] CPX-specific status LEDs
- [3] Fieldbus interface (Sub-D socket, 9-pin)
- [4] DIL switch cover

Pin allocation for PROFIBUS DP interface



| Terminal allocation | Pin | Signal | Designation |
|---|-----------|-----------------------|-------------------------------------|
| Sub-D socket | | | |
| | 1 | n.c. | Not connected |
| | 2 | n.c. | Not connected |
| | 3 | RxD/TxD-P | Received/transmitted data P |
| | 4 | CNTR-P ¹⁾ | Repeater control signal |
| | 5 | DGND | Data reference potential (M5V) |
| | 6 | VP | Supply voltage (P5V) |
| | 7 | n.c. | Not connected |
| | 8 | RxD/TxD-N | Received/transmitted data N |
| | 9 | n.c. | Not connected |
| Housing | Shielding | Connection to housing | |
| Bus connection M12 adapter (B-coded) | | | |
| Incoming | | | |
| | 1 | n.c. | Not connected |
| | 2 | RxD/TxD-N | Received/transmitted data N |
| | 3 | n.c. | Not connected |
| | 4 | RxD/TxD-P | Received/transmitted data P |
| | 5 and M12 | Shielding | Connection to FE (functional earth) |
| Outgoing | | | |
| | 1 | VP | Supply voltage (P5V) |
| | 2 | RxD/TxD-N | Received/transmitted data N |
| | 3 | DGND | Data reference potential (M5V) |
| | 4 | RxD/TxD-P | Received/transmitted data P |
| | 5 and M12 | Shielding | Connection to FE (functional earth) |

1) The repeater control signal CNTR-P is realised as a TTL signal.

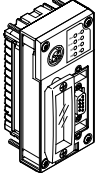
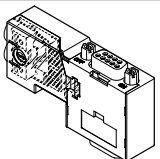
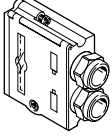
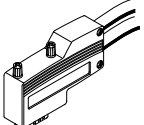
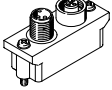
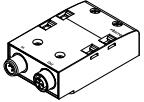
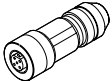
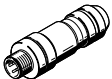
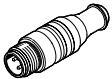
Data sheet – PROFIBUS bus node

| Ordering data | | Part no. | Type |
|---|--|----------|----------------------|
| Designation | | | |
| Bus node | | | |
|  | PROFIBUS bus node | 195740 | CPX-FB13 |
| Bus connection | | | |
|  | Sub-D plug, straight, with terminating resistor and programming interface | 574589 | NECU-S1W9-C2-APB |
|  | Sub-D plug, straight | 532216 | FBS-SUB-9-GS-DP-B |
|  | Sub-D plug, angled | 533780 | FBS-SUB-9-WS-PB-K |
|  | Bus connection M12 adapter (B-coded) | 533118 | FBA-2-M12-5POL-RK |
|  | Connection block M12 adapter (B-coded) | 541519 | CPX-AB-2-M12-RK-DP |
|  | 5-pin M12x1 straight socket, for self-assembly of a connecting cable compatible with FBA-2-M12-5POL-RK and CPX-AB-2-M12-RK-DP | 1067905 | NECU-M-B12G5-C2-PB |
|  | Plug M12x1, 5-pin, straight, for self-assembly of a connecting cable compatible with FBA-2-M12-5POL-RK and CPX-AB-2-M12-RK-DP | 1066354 | NECU-M-S-B12G5-C2-PB |
|  | Terminating resistor, M12, B-coded for PROFIBUS | 1072128 | CACR-S-B12G5-220-PB |

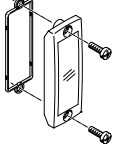
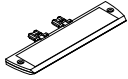
Data sheet – PROFIBUS bus node

| Ordering data | | Part no. | Type | |
|--|--|----------|---------------------|------------------|
| Designation | | | | |
| Bus connection | | | | |
|  | Inspection cover, transparent | 533334 | AK-SUB-9/15-B | |
|  | Inscription label holder for connection block M12 | 536593 | CPX-ST-1 | |
|  | 5-pin M12 to mini USB socket adapter and controller software | 547432 | NEFC-M12G5-0.3-U1G5 | |
| User documentation | | | | |
|  | User documentation for bus node CPX-FB13 | German | 526427 | P.BE-CPX-FB13-DE |
| | | English | 526428 | P.BE-CPX-FB13-EN |
| | | Spanish | 526429 | P.BE-CPX-FB13-ES |
| | | French | 526430 | P.BE-CPX-FB13-FR |
| | | Italian | 526431 | P.BE-CPX-FB13-IT |

Data sheet – CANopen bus node



Bus node for handling communication between the electrical terminal CPX and a CANopen network master or CANopen network.

The bus node is provided with system supply via the interlinking block and processes communication with the I/O modules.

The status of the CPX terminal is displayed as a common message via 4 CPX-specific LEDs.

The different CANopen statuses and the fieldbus communication status are visualised via 3 additional LEDs.

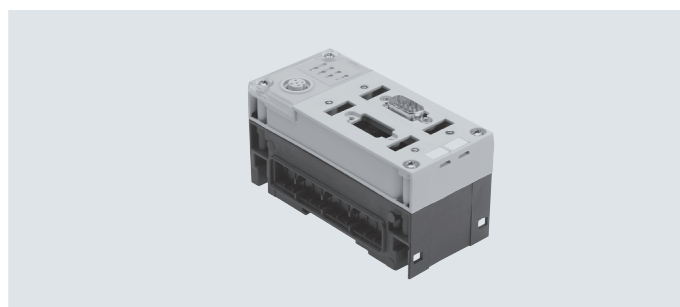

Application

Bus connection

The bus connection is established via a 9-pin Sub-D plug (pin) as per the CAN in Automation (CiA) specification DS 102 with additional 24 V CAN transceiver supply (option as per DS 102).

The bus connector plug (with degree of protection IP65/IP67 from Festo or degree of protection IP20 from other manufacturers) facilitates the connection of an incoming and an outgoing bus cable.

There are 4 contacts available for the 4 wires (CAN_L, CAN_H, 24 V, 0 V) of the incoming and outgoing bus cables respectively.

CANopen implementation

The CPX-FB14 supports the CANopen protocol in accordance with the specifications DS 301 V4.01 and DS 401 V2.0.

Implementation is based on the CiA Predefined Connection Set.

There are 4 PDOs available for fast I/O data exchange.

Enhanced system information can also be accessed via SDO communication. SDO communication also facilitates parameterisation before network start-up or while the controller is running via the user program.

An example of this is access to the integrated diagnostic memory function, i.e. storage of the last 40 errors with timestamp, module, channel and error type.

With its address capacity, the CPX-FB14 supports a large number of I/O module configurations, including pneumatic interface.

By default, 8 byte digital inputs and 8 byte digital outputs can be addressed via PDO 1.

8 analogue input channels and 8 analogue output channels can be addressed via PDO 2 and 3. Status and diagnostic information can be evaluated via PDO 4.

Additional 8 byte digital inputs and outputs as well as 8 analogue input and output channels can be addressed via mapping.

Points to note in connection with CPX-CEC

When a bus node is combined with a control block (CPX-CEC, in the fieldbus remote controller operating mode), the connected I/Os and/or valves, sensors and actuators are controlled via the CPX control block.

In this case, the bus node only provides the communication interface to the PLC.

Communication between the control block and CPX bus node takes place by interlinking the CPX modules and takes

up the following address capacity in the CPX system:

- 8 byte outputs
- 8 byte inputs

The following address capacity remains in the control block or CPX system for activating the peripherals:

- 56 byte inputs
- 56 byte outputs

Data sheet – CANopen bus node

| General technical data | | | |
|---|--|--|----------------------------------|
| Type | CPX-FB14 | | |
| Fieldbus interface | Sub-D plug, 9-pin (to DS 102) Bus interface galvanically isolated via optocoupler 24 V supply for CAN interface via bus | | |
| Baud rate | [kbps] | 125, 250, 500 and 1000 can be set via DIL switch | |
| Addressing range | Node ID 1 ... 127 Set using DIL switch | | |
| Product family | Digital inputs and outputs | | |
| Communication profile | DS 301, V4.01 | | |
| Device profile | DS 401, V2.0 | | |
| Number | PDO | 4 Tx/4 Rx | |
| | SDO | 1 server SDO | |
| Configuration support | EDS file and bitmaps | | |
| Max. address capacity | Inputs | [byte] | 16 digital, 16 analogue channels |
| | Outputs | [byte] | 16 digital, 16 analogue channels |
| LED displays (bus-specific) | MS = Module status NS = Network status IO = I/O status | | |
| Device-specific diagnostics | Via emergency message Object 1001, 1002 and 1003 | | |
| Parameterisation | Via SDO | | |
| Additional functions | <ul style="list-style-type: none"> • Storage of the last 40 errors with timestamp (access via SDO) • 8-bit system status via transmit PDO 4 (default) • 2-byte inputs and 2-byte outputs, system diagnostics via PDO 4 • Minimum boot-up • Variable PDO mapping • Emergency message • Node guarding • Heart beat | | |
| Control elements | DIL switch | | |
| Operating voltage | Nominal value | [V DC] | 24 |
| | Permissible range | [V DC] | 18 ... 30 |
| | Power failure buffering | [ms] | 10 |
| Current consumption | | | [mA] Typically 200 |
| Degree of protection to EN 60529 | IP65, IP67 | | |
| Temperature range | Operation | [°C] | -5 ... +50 |
| | Storage/transport | [°C] | -20 ... +70 |
| Materials | Reinforced PA, PC | | |
| PWIS conformity | VDMA24364-B2-L | | |
| Grid dimension | | | [mm] 50 |
| Dimensions (including interlinking block) W x L x H | | | [mm] 50 x 107 x 50 |
| Product weight | | | [g] 115 |

 **Note**

Please observe the general limits and guidelines for the system when configuring the electrical modules.

Data sheet – CANopen bus node

Connection and display components

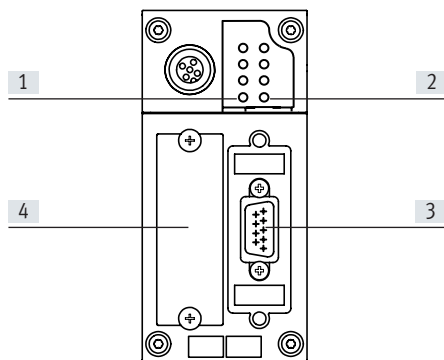





- [1] Bus-specific LEDs
- [2] CPX-specific status LEDs
- [3] Fieldbus interface (Sub-D plug, 9-pin)
- [4] DIL switch cover

Pin allocation of the CANopen interface

| Terminal allocation | Pin | Signal | Designation |
|---|-----------|-------------------------------------|-------------------------------------|
| Sub-D plug | | | |
| | 1 | n.c. | Not connected |
| | 2 | CAN_L | Received/transmitted data low |
| | 3 | CAN_GND | 0 V CAN interface |
| | 4 | n.c. | Not connected |
| | 5 | CAN_SHLD | Optional shielded connection |
| | 6 | GND | Ground ¹⁾ |
| | 7 | CAN_H | Received/transmitted data high |
| | 8 | n.c. | Not connected |
| | 9 | CAN_V+ | 24 V DC supply CAN interface |
| Housing | Shielding | Connection to FE (functional earth) | |
| Micro style bus connection (M12) | | | |
| Incoming | | | |
| | 1 | Shielding | Connection to FE (functional earth) |
| | 2 | CAN_V+ | 24 V DC supply CAN interface |
| | 3 | CAN_GND | 0 V CAN interface |
| | 4 | CAN_H | Received/transmitted data high |
| | 5 | CAN_L | Received/transmitted data low |
| Outgoing | | | |
| | 1 | Shielding | Connection to FE (functional earth) |
| | 2 | CAN_V+ | 24 V DC supply CAN interface |
| | 3 | CAN_GND | 0 V CAN interface |
| | 4 | CAN_H | Received/transmitted data high |
| | 5 | CAN_L | Received/transmitted data low |
| Open style bus connection | | | |
| | 1 | CAN_GND | 0 V CAN interface |
| | 2 | CAN_L | Received/transmitted data low |
| | 3 | Shielding | Connection to FE (functional earth) |
| | 4 | CAN_H | Received/transmitted data high |
| | 5 | CAN_V+ | 24 V DC supply CAN interface |

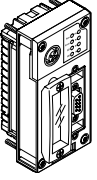
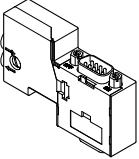
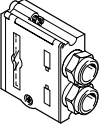
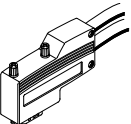
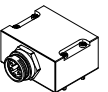
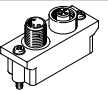
1) Connected internally via Pin 3

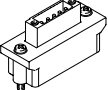
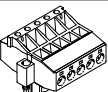
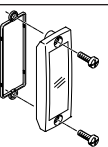
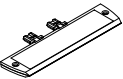
Data sheet – CANopen bus node

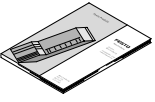
| Ordering data | | Part no. | Type |
|--|--|----------|-------------------------|
| Designation | | | |
| Bus node | | | |
|  | CANopen bus node | 526174 | CPX-FB14 |
| Bus connection | | | |
|  | Sub-D socket for CANopen with terminating resistor and programming interface | 574588 | NECU-S1W9-C2-ACO |
|  | Sub-D socket | 532219 | FBS-SUB-9-BU-2x5POL-B |
|  | Sub-D socket, angled | 533783 | FBS-SUB-9-WS-CO-K |
|  | Connection block, 9-pin Sub-D socket, 5-pin 7/8" plug | 571052 | CPX-AB-1-7/8-DN |
|  | Micro style bus connection, 2xM12, 5-pin | 525632 | FBA-2-M12-5POL |
|  | Fieldbus socket for micro style connection, M12, 5-pin | 18324 | FBSD-GD-9-5POL |
| | Plug for micro style connection, M12, 5-pin | 175380 | FBS-M12-5GS-PG9 |
|  | Open style bus connection | 525634 | FBA-1-SL-5POL |
|  | Terminal strip for open style connection, 5-pin | 525635 | FBSD-KL-2x5POL |
|  | Inspection cover, transparent | 533334 | AK-SUB-9/15-B |
|  | Inscription label holder for connection block | 536593 | CPX-ST-1 |
|  | 5-pin M12 to mini USB socket adapter and controller software | 547432 | NEFC-M12G5-0.3-U1G5 |
| User documentation | | | |
|  | User documentation for bus node CPX-FB14 | German | 526409 P.BE-CPX-FB14-DE |
| | | English | 526410 P.BE-CPX-FB14-EN |
| | | Spanish | 526411 P.BE-CPX-FB14-ES |
| | | French | 526412 P.BE-CPX-FB14-FR |
| | | Italian | 526413 P.BE-CPX-FB14-IT |

Data sheet – CC-Link bus node

CC-Link

Bus node for handling communication between the electrical terminal CPX and a higher-order master for Control & Communication-Link (CC-Link) from Mitsubishi.

The bus node is provided with system supply via the interlinking block and processes communication with the I/O modules.

The status of the CPX terminal is displayed as a common message via 4 CPX-specific LEDs.

The fieldbus communication status is displayed via 4 CC-Link-specific LEDs.



Application

Bus connection

The bus connection can be selected when ordering and is established via a screw terminal with degree of protection IP20, a Sub-D plug with degree of

protection IP65/IP67 from Festo or degree of protection IP20 from other manufacturers.

Both connection types have the function of an integrated T-distributor and thus support the connection of an incoming and outgoing bus cable.

CC-Link implementation

The CPX bus node CPX-FB23-24 optionally supports the CC-Link versions 2.0 (as function module F24) and 1.1 (as function module F23).

These designations are also found in the system diagram for the CPX Maintenance Tool (CPX-FMT) from Festo.

Function module F24 corresponds to CC-Link version 2.0 and supports a maximum of four stations per slave, up to an address capacity of 64 bytes of digital I/O and 64 bytes of analogue I/O in each case.

It is possible to optimise the configuration of the addressing in terms of either cycle time or station.

Function module F23 corresponds to CC-Link version 1.1 and supports a maximum of four stations per slave, up to an address capacity of 32 bytes of digital I/O and 14 bytes of analogue I/O in each case.

The function module and option are set using the DIL switch on the CPX bus node.

Points to note in connection with CPX-CEC

When a bus node is combined with a control block (CPX-CEC, in the fieldbus remote controller operating mode), the connected I/Os and/or valves, sensors and actuators are controlled via the CPX control block.

In this case, the bus node only provides the communication interface to the PLC.

Communication between the control block and CPX bus node takes place by interlinking the CPX modules and takes

up the following address capacity in the CPX system:

- 8 byte outputs
- 8 byte inputs

The following address capacity remains in the control block or CPX system for activating the peripherals:

- 56 byte inputs
- 56 byte outputs

Data sheet – CC-Link bus node

| General technical data | | | | |
|---|--|---------------|---------------|----|
| Type | CPX-FB23-24 | | | |
| Fieldbus interface | Either <ul style="list-style-type: none"> • Sub-D socket, 9-pin • Sub-D plug, for self-assembly • Screw terminal strip, IP20 | | | |
| Baud rate | [kbps] | 156 ... 10000 | | |
| Protocol | CC-Link | | | |
| Max. address capacity, inputs | FB23 | RWr | [byte] | 32 |
| | | Rx | [byte] | 14 |
| | FB24 | RWr | [byte] | 64 |
| | | Rx | [byte] | 64 |
| Max. address volume for outputs | FB23 | RWw | [byte] | 32 |
| | | Ry | [byte] | 14 |
| | FB24 | RWw | [byte] | 64 |
| | | Ry | [byte] | 64 |
| LED displays (bus-specific) | RUN = Communication status ERROR = Communication error SD = Send data RD = Receive data | | | |
| Device-specific diagnostics | <ul style="list-style-type: none"> • Diagnostic memory • Channel and module-oriented diagnostics • Undervoltage of modules | | | |
| Parameterisation | <ul style="list-style-type: none"> • Diagnostic behaviour • Fail-safe response • Forcing of channels • Signal setup • System parameters | | | |
| Additional functions | <ul style="list-style-type: none"> • System status can be displayed using process data • Additional diagnostic interface for operator units | | | |
| Control elements | DIL switch | | | |
| Operating voltage | Nominal value | [V DC] | 24 | |
| | Permissible range | [V DC] | 18 ... 30 | |
| Current consumption | | [mA] | Typically 200 | |
| Degree of protection to EN 60529 | IP65, IP67 | | | |
| Temperature range | Operation | [°C] | -5 ... +50 | |
| | Storage/transport | [°C] | -20 ... +70 | |
| Materials | Reinforced PA, PC | | | |
| PWIS conformity | VDMA24364-B2-L | | | |
| Grid dimension | | [mm] | 50 | |
| Dimensions (including interlinking block) W x L x H | | [mm] | 50 x 107 x 50 | |
| Product weight | | [g] | 115 | |

Note

Please observe the general limits and guidelines for the system when configuring the electrical modules.

Data sheet – CC-Link bus node

Connection and display components

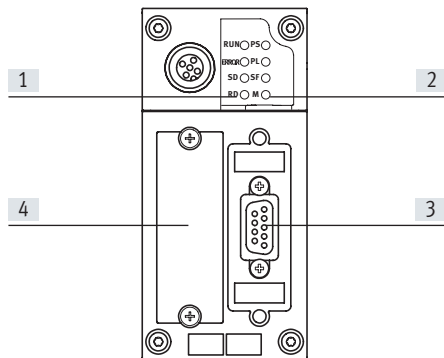



- [1] Bus-specific status LEDs
- [2] CPX-specific status LEDs
- [3] Fieldbus interface (Sub-D socket, 9-pin)
- [4] DIL switch cover

Pin allocation for the CC-Link interface

| Terminal allocation | Pin | Signal | Designation |
|--------------------------------------|-----|------------------|--------------------------|
| Sub-D socket | | | |
| | 1 | n.c. | Not connected |
| | 2 | DA | Data A |
| | 3 | DG | Data reference potential |
| | 4 | n.c. | Not connected |
| | 5 | FE ¹⁾ | Functional earth |
| | 6 | n.c. | Not connected |
| | 7 | DB | Data B |
| | 8 | n.c. | Not connected |
| | 9 | n.c. | Not connected |
| Screw terminal bus connection | | | |
| | 1 | FG | Functional earth/housing |
| | 2 | SLD | Shielding |
| | 3 | DG | Data reference potential |
| | 4 | DB | Data B |
| | 5 | DA | Data A |

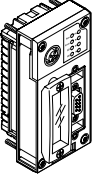
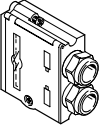
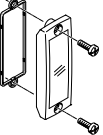
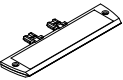
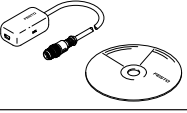
Data sheet – CC-Link bus node

| Ordering data | | Part no. | Type |
|--|--|----------|-----------------------------|
| Bus node | | | |
|  | CC-Link bus node | 526176 | CPX-FB23-24 |
| Bus connection | | | |
|  | Sub-D plug | 532220 | FBS-SUB-9-GS-2x4POL-B |
|  | Inspection cover, transparent | 533334 | AK-SUB-9/15-B |
|  | Inscription label holder for connection block | 536593 | CPX-ST-1 |
|  | 5-pin M12 to mini USB socket adapter and controller software | 547432 | NEFC-M12G5-0.3-U1G5 |
| User documentation | | | |
|  | User documentation for bus node CPX-FB23-24 | German | 526403 P.BE-CPX-FB23-24-DE |
| | | English | 526404 P.BE-CPX-FB23-24-EN |
| | | Chinese | 8026069 P.BE-CPX-FB23-24-ZH |

Data sheet – PROFINET bus node, M12, D-coded



Bus node for operating the CPX valve terminal on PROFINET.

The bus node is provided with system supply via the interlinking block and processes communication with the I/O modules.

The status of the CPX terminal is displayed as a common message via 4 CPX-specific LEDs.

The fieldbus communication status is displayed via three bus-specific LEDs.

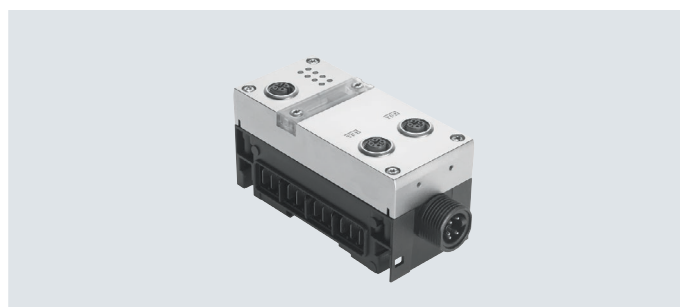

Application

Bus connection

The bus connection is established via two M12 sockets, D-coded to IEC 61076-2-101 with degree of protection IP65, IP67.

Both connections are equivalent 100BaseTX Ethernet ports with integrated auto MDI functionality (crossover and patch cables can be used) that are brought together via an internal switch.

- Maximum segment length 100 m
- Transmission rate 100 Mbps

PROFINET implementation

The bus nodes support the PROFINET protocol on the basis of the Ethernet standard and TCP/IP technology to IEEE802.3.

This guarantees a data exchange with a high data transmission rate, for example I/O data from sensors, actuators or robot controllers, PLCs or process equipment. In addition, non-real-time critical information such as diagnostic

information, configuration information, etc. can be transferred. The Ethernet bandwidth is sufficient to transfer both data types (real-time and non-real-time) in parallel.

The bus node features LEDs for bus status and CPX peripheral information as well as switch elements and a diagnostic interface. PROFINET provides the user with access to all peripherals, diagnostic data and parameter data of the CPX valve terminal. The bus node can be used as a remote I/O or remote controller. All information relevant to the CPX can be read out and, depend-

ent on the function, changed via CPX-FMT.

Points to note in connection with CPX-CEC

When a bus node is combined with a control block (CPX-CEC, in the fieldbus remote controller operating mode), the connected I/Os and/or valves, sensors and actuators are controlled via the CPX control block.

In this case, the bus node only provides the communication interface to the PLC.

Communication between the control block and CPX bus node takes place by interlinking the CPX modules and takes

up the following address capacity in the CPX system:

- 8 byte outputs
- 8 byte inputs

The following address capacity remains in the control block or CPX system for activating the peripherals:

- 56 byte inputs
- 56 byte outputs

Data sheet – PROFINET bus node, M12, D-coded

| General technical data | | | |
|---|---|--------------------|--|
| Type | CPX-FB43 | | |
| Fieldbus interface | 2x socket, M12, 4-pin, D-coded | | |
| Baud rate | [Mbps] | 100 | |
| Protocol | PROFINET RT PROFINET IRT | | |
| Max. address capacity | Inputs | [byte] | 64 |
| | Outputs | [byte] | 64 |
| LED displays | (bus-specific) | | M/P = Maintenance/PROFenergy NF = Network fault TP1 = Network active port 1 TP2 = Network active port 2 |
| | (product-specific) | | M = Modify, parameterisation PL = Load supply PS = Electronic supply, sensor supply SF = System fault |
| Device-specific diagnostics | <ul style="list-style-type: none"> Channel and module-oriented diagnostics Undervoltage of modules Diagnostic memory | | |
| Configuration support | GSDML file | | |
| Parameterisation | <ul style="list-style-type: none"> System parameters Diagnostic behaviour Signal setup Fail-safe response Forcing of channels | | |
| Additional functions | <ul style="list-style-type: none"> Start-up parameterisation in plain text via fieldbus Fast start-up (FSU) Channel-oriented diagnostics via fieldbus Acyclic data access via fieldbus and via Ethernet System status can be displayed using process data Additional diagnostic interface for operator unit | | |
| | <ul style="list-style-type: none"> I&M LLDP MRP MRPD MQTT PROFIsafe PROFenergy S2 system redundancy | | |
| Control elements | <ul style="list-style-type: none"> DIL switch | | |
| Operating voltage | Nominal value | [V DC] | 24 |
| | Permissible range | [V DC] | 18 ... 30 |
| Current consumption | | [mA] | Typically 70 |
| Degree of protection to EN 60529 | IP65, IP67 | | |
| Temperature range | Operation | [°C] | - 5... +50 |
| | Storage/transport | [°C] | -20 ... +70 |
| Certification | RCM | | |
| Materials | Housing | Die-cast aluminium | |
| Note on materials | RoHS-compliant | | |
| PWIS conformity | VDMA24364-B2-L | | |
| Dimensions (including interlinking block) W x L x H | | [mm] | 50 x 107 x 50 |
| Product weight | | [g] | 185 |

 **Note**
Please observe the general limits and guidelines for the system when configuring the electrical modules.

 **Note**
Always use the correct screws for the interlinking block; this depends on whether the block is made of metal or plastic:

- Self-tapping screws for plastic interlinking blocks
- Screws with metric thread for metal interlinking blocks

Data sheet – PROFINET bus node, M12, D-coded

Connection and display components

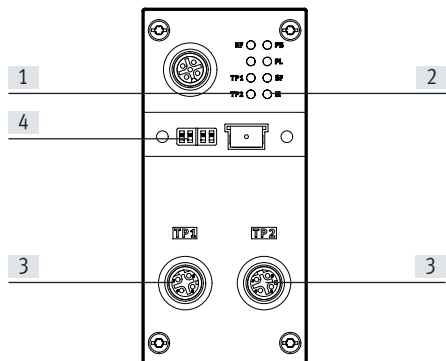



- [1] Bus-specific status LEDs
- [2] CPX-specific status LEDs
- [3] Fieldbus interface (M12 socket, 4-pin, D-coded)
- [4] Transparent cover for DIL switch

Pin allocation for the fieldbus interface

| Terminal allocation | Pin | Signal | Designation |
|-----------------------------|---------|--------|-------------------|
| Socket, M12, D-coded | | | |
| | 1 | TD+ | Transmitted data+ |
| | 2 | RD+ | Received data+ |
| | 3 | TD- | Transmitted data- |
| | 4 | RD- | Received data- |
| | Housing | | Shielding |

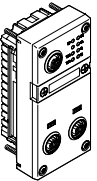
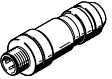
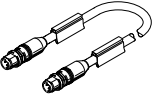
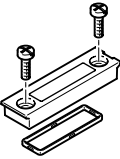
Data sheet – PROFINET bus node, M12, D-coded

| Ordering data | | | Part no. | Type | |
|--|--|---|----------------------------|--------------------------|------------------------------|
| Designation | | | | | |
| Bus node | | | | | |
|  | PROFINET bus node | <ul style="list-style-type: none"> • I&M • LLDP • MRP • MRPD • PROFIenergy • S2 system redundancy | 8110369 | CPX-FB43 | |
| Bus connection | | | | | |
|  | Plug M12x1, 4-pin, D-coded | | 543109 | NECU-M-S-D12G4-C2-ET | |
|  | Connecting cable, straight plug, M12x1, 4-pin, D-coded | Straight plug, M12x1, 4-pin, D-coded | 0.5 m | 8040446 | NEBC-D12G4-ES-0.5-S-D12G4-ET |
| | | | 1 m | 8040447 | NEBC-D12G4-ES-1-S-D12G4-ET |
| | | | 3 m | 8040448 | NEBC-D12G4-ES-3-S-D12G4-ET |
| | | | 5 m | 8040449 | NEBC-D12G4-ES-5-S-D12G4-ET |
| | | | 10 m | 8040450 | NEBC-D12G4-ES-10-S-D12G4-ET |
| | | Straight plug, RJ45, 8-pin | 1 m | 8040451 | NEBC-D12G4-ES-1-S-R3G4-ET |
| | | | 3 m | 8040452 | NEBC-D12G4-ES-3-S-R3G4-ET |
| | | | 5 m | 8040453 | NEBC-D12G4-ES-5-S-R3G4-ET |
| Open end, 4-wire | 10 m | 8040454 | NEBC-D12G4-ES-10-S-R3G4-ET | | |
| 5 m | 8040456 | NEBC-LE4-ES-5-D12G4-ET | | | |
|  | Transparent cover for DIL switch | | 548757 | CPX-AK-P | |
|  | Cover cap for sealing unused bus connections (10 pieces) | | 165592 | ISK-M12 | |
| User documentation | | | | | |
|  | Electronics manual, CPX bus node | German | 548759 | CPX-(M)-FB33_35/43_45-DE | |
| | | English | 548760 | CPX-(M)-FB33_35/43_45-EN | |
| | | Spanish | 548761 | CPX-(M)-FB33_35/43_45-ES | |
| | | French | 548762 | CPX-(M)-FB33_35/43_45-FR | |
| | | Italian | 548763 | CPX-(M)-FB33_35/43_45-IT | |

Data sheet – PROFINET bus node, push-pull RJ45



Bus node for operating the CPX valve terminal on PROFINET.

The bus node is provided with system supply via the interlinking block and processes communication with the I/O modules.

The status of the CPX terminal is displayed as a common message via 4 CPX-specific LEDs.

The fieldbus communication status is displayed via 4 bus-specific LEDs.

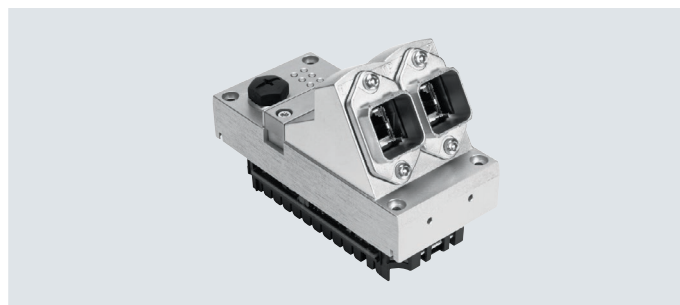

Application

Bus connection

The bus connection is established via two RJ45 push-pull sockets to IEC 61076-3-106 and IEC 60603 with degree of protection IP65, IP67.

Both connections are equivalent 100BaseTX Ethernet ports with integrated auto MDI functionality (crossover and patch cables can be used) that are brought together via an internal switch.

- Maximum segment length 100 m
- Transmission rate 100 Mbps

PROFINET implementation

The bus nodes support the PROFINET protocol on the basis of the Ethernet standard and TCP/IP technology to IEEE802.3.

This guarantees a data exchange with a high data transmission rate, for example I/O data from sensors, actuators or robot controllers, PLCs or process equipment. In addition, non-real-time critical information such as diagnostic

information, configuration information, etc. can be transferred.

The Ethernet bandwidth is sufficient to transfer both data types (real-time and non-real-time) in parallel.

The bus nodes feature LEDs for bus status and CPX peripheral information as well as switch elements and a diagnostic interface. PROFINET provides the user with access to all peripherals, diagnostic data and parameter data of the CPX valve terminal. The bus node can be used as a remote I/O or remote controller. All information relevant to the CPX can be read out and, depend-

ent on the function, changed via CPX-FMT.

Points to note in connection with CPX-CEC

When a bus node is combined with a control block (CPX-CEC, in the fieldbus remote controller operating mode), the connected I/Os and/or valves, sensors and actuators are controlled via the CPX control block.

In this case, the bus node only provides the communication interface to the PLC.

Communication between the control block and CPX bus node takes place by interlinking the CPX modules and takes

up the following address capacity in the CPX system:

- 8/16 byte outputs
- 8/16 byte inputs

The following address capacity remains in the control block or CPX system for activating the peripherals:

- 56/48 byte inputs
- 56/48 byte outputs

Data sheet – PROFINET bus node, push-pull RJ45

| General technical data | | | |
|--|---|---------------|--|
| Type | CPX-M-FB44 | | |
| Fieldbus interface | 2x RJ45 push-pull socket, AIDA | | |
| Baud rate | [Mbps] | 100 | |
| Protocol | PROFINET RT PROFINET IRT | | |
| Max. address capacity | Inputs | [byte] | 64 |
| | Outputs | [byte] | 64 |
| LED displays | (bus-specific) | | M/P = Maintenance/PROFenergy NF = Network fault TP1 = Network active port 1 TP2 = Network active port 2 |
| | (product-specific) | | M = Modify, parameterisation PL = Load supply PS = Electronic supply, sensor supply SF = System fault |
| Device-specific diagnostics | <ul style="list-style-type: none"> Channel and module-oriented diagnostics Undervoltage of modules Diagnostic memory | | |
| Configuration support | GSDML file | | |
| Parameterisation | <ul style="list-style-type: none"> System parameters Diagnostic behaviour Signal setup Fail-safe response Forcing of channels | | |
| Additional functions | <ul style="list-style-type: none"> Start-up parameterisation in plain text via fieldbus Fast start-up (FSU) Channel-oriented diagnostics via fieldbus Acyclic data access via fieldbus and via Ethernet System status can be displayed using process data Additional diagnostic interface for operator unit | | |
| | <ul style="list-style-type: none"> I&M LLDP MRP MRPD MQTT PROFIsafe PROFenergy S2 system redundancy | | |
| Control elements | <ul style="list-style-type: none"> DIL switch | | |
| Operating voltage | Nominal value | [V DC] | 24 |
| | Permissible range | [V DC] | 18 ... 30 |
| Intrinsic current consumption at nominal operating voltage | [mA] | Typically 70 | |
| Degree of protection to EN 60529 | IP65, IP67 | | |
| Temperature range | Operation | [°C] | - 5... +50 |
| | Storage/transport | [°C] | -20 ... +70 |
| Certification | RCM | | |
| Housing material | Die-cast aluminium | | |
| Note on materials | RoHS-compliant | | |
| PWIS conformity | VDMA24364-B2-L | | |
| Dimensions (including interlinking block) W x L x H | [mm] | 50 x 107 x 80 | |
| Product weight | [g] | 280 | |

**Note**

Please observe the general limits and guidelines for the system when configuring the electrical modules.

**Note**

Always use the correct screws for the interlinking block; this depends on whether the block is made of metal or plastic:

- Self-tapping screws for plastic interlinking blocks
- Screws with metric thread for metal interlinking blocks

Data sheet – PROFINET bus node, push-pull RJ45

Connection and display components

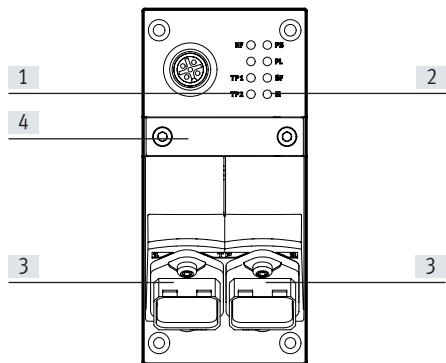

- [1] Bus-specific status LEDs
- [2] CPX-specific status LEDs
- [3] Fieldbus interface (RJ45 socket, 8-pin)
- [4] DIL switch

Pin allocation for the fieldbus interface

| Terminal allocation | Pin | Signal | Designation |
|---------------------|---------|-----------|-------------------|
| RJ45 socket | | | |
| | 1 | TD+ | Transmitted data+ |
| | 2 | TD- | Transmitted data- |
| | 3 | RD+ | Received data+ |
| | 4 | n.c. | Not connected |
| | 5 | n.c. | Not connected |
| | 6 | RD- | Received data- |
| | 7 | n.c. | Not connected |
| | 8 | n.c. | Not connected |
| | Housing | Shielding | Shielding |

Data sheet – PROFINET bus node, push-pull RJ45

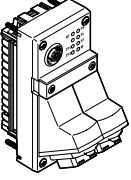
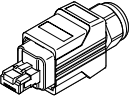
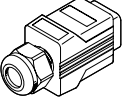
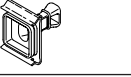
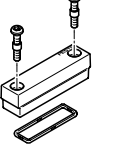
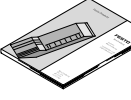
| Ordering data | | Part no. | Type | | | | | | | | | | | | | | | |
|--|----------------------------------|--|------------------------------|---------------|--------------------------|---------|---------------|--------------------------|---------|---------------|--------------------------|--------|---------------|--------------------------|---------|---------------|--------------------------|--|
| Designation | | | | | | | | | | | | | | | | | | |
| Bus node | | | | | | | | | | | | | | | | | | |
|  | PROFINET bus node | <ul style="list-style-type: none"> • I&M • LLDP • MRP • MRPD • PROFinergy • S2 system redundancy | 8110370 CPX-M-FB44 | | | | | | | | | | | | | | | |
| Bus connection | | | | | | | | | | | | | | | | | | |
|  | RJ45 plug, 8-pin, push-pull | | 552000 FBS-RJ45-PP-GS | | | | | | | | | | | | | | | |
|  | Cover cap for bus connection | | 548753 CPX-M-AK-C | | | | | | | | | | | | | | | |
|  | Cover cap for bus connection | | 2873540 CPX-M-AK-D | | | | | | | | | | | | | | | |
|  | Cover for DIL switch | | 548754 CPX-M-AK-M | | | | | | | | | | | | | | | |
| User documentation | | | | | | | | | | | | | | | | | | |
|  | Electronics manual, CPX bus node | <table border="1"> <tr> <td>German</td> <td>548759</td> <td>CPX-(M)-FB33_35/43_45-DE</td> </tr> <tr> <td>English</td> <td>548760</td> <td>CPX-(M)-FB33_35/43_45-EN</td> </tr> <tr> <td>Spanish</td> <td>548761</td> <td>CPX-(M)-FB33_35/43_45-ES</td> </tr> <tr> <td>French</td> <td>548762</td> <td>CPX-(M)-FB33_35/43_45-FR</td> </tr> <tr> <td>Italian</td> <td>548763</td> <td>CPX-(M)-FB33_35/43_45-IT</td> </tr> </table> | German | 548759 | CPX-(M)-FB33_35/43_45-DE | English | 548760 | CPX-(M)-FB33_35/43_45-EN | Spanish | 548761 | CPX-(M)-FB33_35/43_45-ES | French | 548762 | CPX-(M)-FB33_35/43_45-FR | Italian | 548763 | CPX-(M)-FB33_35/43_45-IT | |
| German | 548759 | CPX-(M)-FB33_35/43_45-DE | | | | | | | | | | | | | | | | |
| English | 548760 | CPX-(M)-FB33_35/43_45-EN | | | | | | | | | | | | | | | | |
| Spanish | 548761 | CPX-(M)-FB33_35/43_45-ES | | | | | | | | | | | | | | | | |
| French | 548762 | CPX-(M)-FB33_35/43_45-FR | | | | | | | | | | | | | | | | |
| Italian | 548763 | CPX-(M)-FB33_35/43_45-IT | | | | | | | | | | | | | | | | |

Data sheet – PROFINET bus node, push-pull SCRJ



Bus node for operating the CPX valve terminal on PROFINET.

The bus node is provided with system supply via the interlinking block and processes communication with the I/O modules.

The status of the CPX terminal is displayed as a common message via 4 CPX-specific LEDs.

The fieldbus communication status is displayed via three bus-specific LEDs.

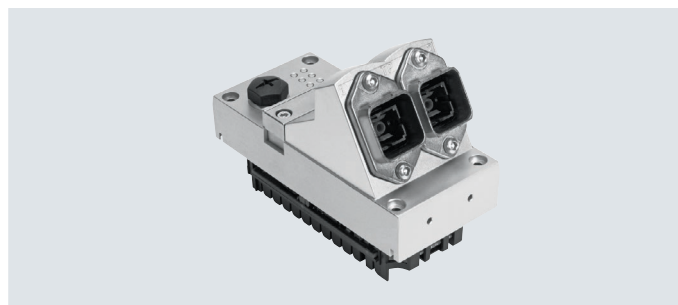

Application

Bus connection

The bus connection is established via SCRJ push-pull sockets to IEC 61754-24 (fibre-optic cable, AIDA standard) with degree of protection IP65, IP67.

The connections on the CPX bus node are equivalent 100BaseFX Ethernet ports that are brought together via an internal switch.

Fibre-optic cables made from plastic (POF, 980/1000 µm) are also suitable for transmission.

- Maximum segment length 50 m
- Transmission rate 100 Mbps
- Supports LLDP and SNMP

PROFINET implementation

The bus nodes support the PROFINET protocol on the basis of the Ethernet standard and TCP/IP technology to IEEE802.3.

This guarantees a data exchange with a high data transmission rate, for example I/O data from sensors, actuators or robot controllers, PLCs or process equipment. In addition, non-real-time critical information such as diagnostic

information, configuration information, etc. can be transferred.

The Ethernet bandwidth is sufficient to transfer both data types (real-time and non-real-time) in parallel.

The bus node features LEDs for bus status and CPX peripheral information as well as switch elements and a diagnostic interface. PROFINET provides the user with access to all peripheral, diagnostic and parameter data for the CPX valve terminal. The bus node can be used as a remote I/O or remote controller. All information relevant to the

CPX can be read out and, dependent on the function, changed via CPX-FMT.

Points to note in connection with CPX-CEC

When a bus node is combined with a control block (CPX-CEC, in the fieldbus remote controller operating mode), the connected I/Os and/or valves, sensors and actuators are controlled via the CPX control block.

In this case, the bus node only provides the communication interface to the PLC.

Communication between the control block and CPX bus node takes place by interlinking the CPX modules and takes

up the following address capacity in the CPX system:

- 8/16 byte outputs
- 8/16 byte inputs

The following address capacity remains in the control block or CPX system for activating the peripherals:

- 56/48 byte inputs
- 56/48 byte outputs

Data sheet – PROFINET bus node, push-pull SCRJ

| General technical data | | | |
|--|---|---------------|--|
| Type | CPX-M-FB45 | | |
| Fieldbus interface | 2x SCRJ push-pull socket, AIDA | | |
| Baud rate | [Mbps] | 100 | |
| Protocol | PROFINET RT PROFINET IRT | | |
| Max. address capacity | Inputs | [byte] | 64 |
| | Outputs | [byte] | 64 |
| LED displays | (bus-specific) | | M/P = Maintenance/PROFenergy NF = Network fault TP1 = Network active port 1 TP2 = Network active port 2 |
| | (product-specific) | | M = Modify, parameterisation PL = Load supply PS = Electronic supply, sensor supply SF = System fault |
| Device-specific diagnostics | <ul style="list-style-type: none"> Channel and module-oriented diagnostics Undervoltage of modules Diagnostic memory | | |
| Configuration support | GSDML file | | |
| Parameterisation | <ul style="list-style-type: none"> System parameters Diagnostic behaviour Signal setup Fail-safe response Forcing of channels | | |
| Additional functions | <ul style="list-style-type: none"> Start-up parameterisation in plain text via fieldbus Fast start-up (FSU) Channel-oriented diagnostics via fieldbus Acyclic data access via fieldbus and via Ethernet System status can be displayed using process data Additional diagnostic interface for operator unit | | |
| | <ul style="list-style-type: none"> I&M LLDP MRP MRPD MQTT PROFIsafe PROFenergy S2 system redundancy | | |
| Control elements | DIL switch | | |
| Operating voltage | Nominal value | [V DC] | 24 |
| | Permissible range | [V DC] | 18 ... 30 |
| Intrinsic current consumption at nominal operating voltage | [mA] | Typically 145 | |
| Certification | RCM | | |
| Degree of protection to EN 60529 | IP65, IP67 | | |
| Temperature range | Operation | [°C] | -5 ... +50 |
| | Storage/transport | [°C] | -20 ... +70 |
| Housing material | Die-cast aluminium | | |
| Note on materials | RoHS-compliant | | |
| PWIS conformity | VDMA24364-B2-L | | |
| Grid dimension | [mm] | 50 | |
| Dimensions (including interlinking block) W x L x H | [mm] | 50 x 107 x 80 | |
| Product weight | [g] | 280 | |

**Note**

Please observe the general limits and guidelines for the system when configuring the electrical modules.

**Note**

Always use the correct screws for the interlinking block; this depends on whether the block is made of metal or plastic:

- Self-tapping screws for plastic interlinking blocks
- Screws with metric thread for metal interlinking blocks

Data sheet – PROFINET bus node, push-pull SCRJ

Connection and display components

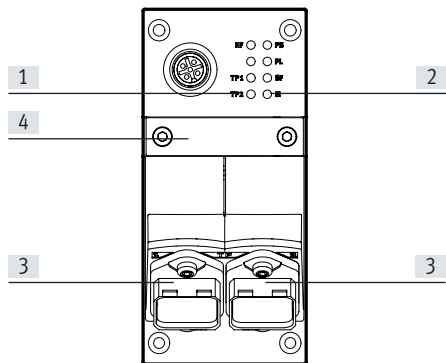



- [1] Bus-specific status LEDs
- [2] CPX-specific status LEDs
- [3] Fieldbus interface (SCRJ) socket, 2-pin)
- [4] DIL switch

Pin allocation for the fieldbus interface

| Terminal allocation | Pin | Signal | Designation |
|---------------------|-----|--------|-------------|
| SCRJ socket | | | |
| | 1 | TX | Outgoing |
| | 2 | Rx | Incoming |

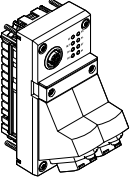
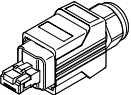
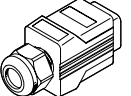
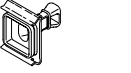
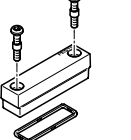
Data sheet – PROFINET bus node, push-pull SCRJ

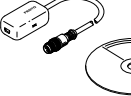
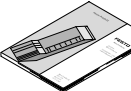
| Ordering data | | Part no. | Type |
|--|---|---|--|
| Designation | | | |
| Bus node | | | |
|  | 2x SCRJ push-pull socket, AIDA | <ul style="list-style-type: none"> • I&M • LLDP • MRP • MRPD • PROFIenergy • S2 system redundancy | 8110371 CPX-M-FB45 |
| Bus connection | | | |
|  | SCRJ plug, 2-pin, push-pull | | 571017 FBS-SCRJ-PP-GS |
|  | Cover cap for bus connection | | 548753 CPX-M-AK-C |
|  | Cover cap for bus connection | | 2873540 CPX-M-AK-D |
|  | Cover for DIL switch | | 548754 CPX-M-AK-M |
|  | Screws for attaching an inscription label to the bus node (12 pieces) | | 550222 CPX-M-M2.5X8-12X |
|  | 5-pin M12 to mini USB socket adapter and controller software | | 547432 NEFC-M12G5-0.3-U1G5 |
| User documentation | | | |
|  | Electronics manual, CPX bus node | German | 548759 CPX-(M)-FB33_35/43_45-DE |
| | | English | 548760 CPX-(M)-FB33_35/43_45-EN |
| | | Spanish | 548761 CPX-(M)-FB33_35/43_45-ES |
| | | French | 548762 CPX-(M)-FB33_35/43_45-FR |
| | | Italian | 548763 CPX-(M)-FB33_35/43_45-IT |

Data sheet – EtherNet/IP bus node

- Industrial Ethernet
- EtherNet/IP
- Web interface

Bus node for handling communication between the electrical terminal CPX and the Ethernet/IP network.

The bus node is provided with system supply via the interlinking block and processes communication with the I/O modules.

The status of the CPX terminal is displayed as a common message via 4 CPX-specific LEDs.

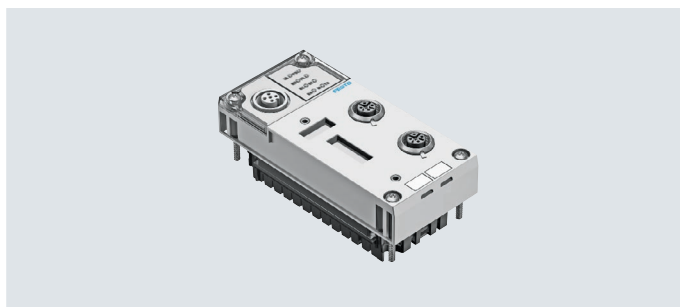

Application

Bus connection

The bus connection is established via an M12 plug, D-coded to IEC 947-5-2 with degree of protection IP65, IP67.

EtherNet/IP is an open bus system based on the Ethernet standard and TCP/IP technology (IEEE802.3).

EtherNet/IP implementation

The CPX-FB36 supports the two operating modes: remote I/O and remote controller.

In remote I/O operating mode, all functions of the CPX valve terminal are di-

rectly controlled by the Ethernet/IP master (host).

In addition to activation via a bus system, it is possible to use IT technologies. An integrated web server enables diagnostic data to be visualised via

HTML. Various programs support direct access to the device data from the automation network.

The Ethernet/IP node for CPX supports the transmission technology that con-

forms to DIN EN 50173/CAT 5 as an integrated interface.

Points to note in connection with CPX-CEC

When a bus node is combined with a control block (CPX-CEC, in the fieldbus remote controller operating mode), the connected I/Os and/or valves, sensors and actuators are controlled via the CPX control block.

In this case, the bus node only provides the communication interface to the PLC.

Communication between the control block and CPX bus node takes place by interlinking the CPX modules and takes

up the following address capacity in the CPX system:

- 8 byte outputs
- 8 byte inputs

The following address capacity remains in the control block or CPX system for activating the peripherals:

- 56 byte inputs
- 56 byte outputs

Data sheet – EtherNet/IP bus node

| General technical data | | | |
|---|--|--------|---------------|
| Type | CPX-FB36 | | |
| Fieldbus interface | 2x M12x1 socket, 4-pin, D-coded | | |
| Baud rate | [Mbps] | 10/100 | |
| Protocol | EtherNet/IP Modbus TCP | | |
| Max. address capacity, inputs | [byte] | 64 | |
| Max. address volume for outputs | [byte] | 64 | |
| LED displays (bus-specific) | MS = Module status NS = network status TP1 = Network active port 1 TP2 = Network active port 2 | | |
| Device-specific diagnostics | <ul style="list-style-type: none"> Module and channel-oriented diagnostics Undervoltage of modules Diagnostic memory | | |
| Configuration support | <ul style="list-style-type: none"> EDS file L5K export with CPX-FMT | | |
| Parameterisation | <ul style="list-style-type: none"> Diagnostic behaviour Fail-safe response Forcing of channels Idle mode characteristics Signal setup System parameters | | |
| Additional functions | <ul style="list-style-type: none"> EtherNet/IP Quickconnect Ring topology (DLR) Acyclic data access via "Explicit Message" and Ethernet Integrated switch IP addressing via DHCP, DIL switch or operator unit Channel-oriented diagnostics via fieldbus Start-up parameterisation in plain text via fieldbus System status can be displayed using process data Additional diagnostic interface for operator units | | |
| Control elements | DIL switch | | |
| Operating voltage | Nominal value | [V DC] | 24 |
| | Permissible range | [V DC] | 18 ... 30 |
| Current consumption at nominal voltage | | [mA] | Typically 100 |
| Degree of protection to EN 60529 | IP65, IP67 | | |
| Temperature range | Operation | [°C] | - 5... +50 |
| | Storage/transport | [°C] | -20 ... +70 |
| Materials | PA-reinforced | | |
| Note on materials | RoHS-compliant | | |
| PWIS conformity | VDMA24364-B2-L | | |
| Grid dimension | | [mm] | 50 |
| Dimensions (including interlinking block) W x L x H | | [mm] | 50 x 107 x 50 |
| Product weight | | [g] | 125 |

 **Note**

Please observe the general limits and guidelines for the system when configuring the electrical modules.

Data sheet – EtherNet/IP bus node

Connection and display components

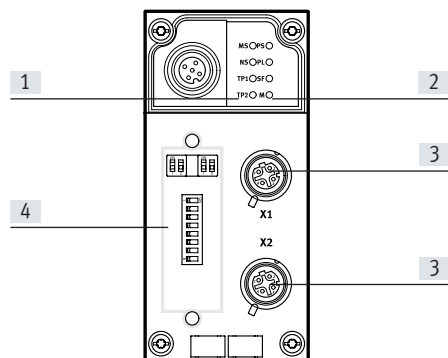



- [1] Bus-specific status LEDs
- [2] CPX-specific status LEDs
- [3] Fieldbus interface (M12 socket, 4-pin, D-coded)
- [4] Transparent DIL switch cover

Pin allocation for the fieldbus interface

| Terminal allocation | Pin | Signal | Designation |
|-----------------------------|---------|--------|-------------------|
| Socket, M12, D-coded | | | |
| | 1 | TD+ | Transmitted data+ |
| | 2 | RD+ | Received data+ |
| | 3 | TD- | Transmitted data- |
| | 4 | RD- | Received data- |
| | Housing | FE | Shielding |

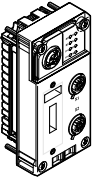
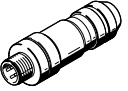
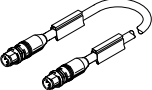
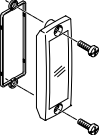
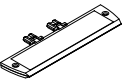
Data sheet – EtherNet/IP bus node

| Ordering data | | | | Part no. | Type |
|--|--|--------------------------------------|------------------------|----------------------------|------------------------------|
| Designation | | | | | |
| Bus node | | | | | |
|  | EtherNet/IP bus node | | | 1912451 | CPX-FB36 |
| Bus connection | | | | | |
|  | Plug M12x1, 4-pin, D-coded | | | 543109 | NECU-M-S-D12G4-C2-ET |
|  | Connecting cable, straight plug, M12x1, 4-pin, D-coded | Straight plug, M12x1, 4-pin, D-coded | 0.5 m | 8040446 | NEBC-D12G4-ES-0.5-S-D12G4-ET |
| | | | 1 m | 8040447 | NEBC-D12G4-ES-1-S-D12G4-ET |
| | | | 3 m | 8040448 | NEBC-D12G4-ES-3-S-D12G4-ET |
| | | | 5 m | 8040449 | NEBC-D12G4-ES-5-S-D12G4-ET |
| | | | 10 m | 8040450 | NEBC-D12G4-ES-10-S-D12G4-ET |
| | Straight plug, RJ45, 8-pin | 1 m | 8040451 | NEBC-D12G4-ES-1-S-R3G4-ET | |
| | | 3 m | 8040452 | NEBC-D12G4-ES-3-S-R3G4-ET | |
| | | 5 m | 8040453 | NEBC-D12G4-ES-5-S-R3G4-ET | |
| | | 10 m | 8040454 | NEBC-D12G4-ES-10-S-R3G4-ET | |
| Open end, 4-wire | 5 m | 8040456 | NEBC-LE4-ES-5-D12G4-ET | | |
|  | Inspection cover, transparent | | | 533334 | AK-SUB-9/15-B |
|  | Inscription label holder for connection block | | | 536593 | CPX-ST-1 |
|  | 5-pin M12 to mini USB socket adapter and controller software | | | 547432 | NEFC-M12G5-0.3-U1G5 |
| User documentation | | | | | |
|  | User documentation for bus node CPX-FB36 | | German | 8024074 | CPX-FB36-DE |
| | | | English | 8024075 | CPX-FB36-EN |
| | | | Spanish | 8024076 | CPX-FB36-ES |
| | | | French | 8024077 | CPX-FB36-FR |
| | | | Italian | 8024078 | CPX-FB36-IT |
| | | | Chinese | 8024079 | CPX-FB36-ZH |

Data sheet – EtherCAT bus node



Bus node for operating the CPX valve terminal on EtherCAT.

The bus node is provided with system supply via the interlinking block and processes communication with the I/O modules.

The status of the CPX terminal is displayed as a common message via 4 CPX-specific LEDs.

The fieldbus communication status is displayed via 4 bus-specific LEDs.

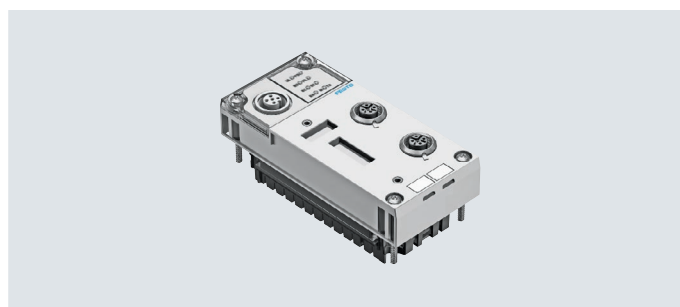

Application

Bus connection

The bus connection is established via two sockets M12x1, D-coded to IEC 61076-2-101 with degree of protection IP65, IP67.

Both connections are equivalent 100BaseTX Ethernet ports with integrated auto MDI functionality (crossover and patch cable can be used) that are brought together via an internal switch.

- Maximum segment length 100 m
- Transmission rate 100 Mbps

EtherCAT implementation

The CPX-FB37 supports the EtherCAT protocol on the basis of the Ethernet standard and TCP/IP technology to IEEE802.3.

This guarantees a data exchange with a high data transmission rate, for example I/O data from sensors, actuators or robot controllers, PLCs or process equipment. In addition, non-real-time critical information such as diagnostic information, configuration information, etc. can be transferred.

The data bandwidth is sufficient to transfer both data types (real-time and non-real-time) in parallel.

The bus node features LEDs for bus status and CPX peripheral information as well as switch elements and a diagnostic interface. The bus node can be used as a remote I/O or remote controller. All information relevant to the CPX can be read out and, dependent on the function, changed via CPX-FMT. The functions MDP (modular device profile) and CoE (CAN over EtherCAT) enable easy access to parameters and diagnostic data via EtherCAT.

Specific EtherCAT functions:

- CoE (parameters and diagnostics or fail-safe mode): all module parameters can be set
- FoE (file over EtherCAT) makes it possible to download firmware easily
- EoE (Ethernet over EtherCAT): diagnostic data can be retrieved easily using a browser
- MDP (modular device profile): easy configuration using a module selection box
- Hot Connect, easy replacement of an EtherCAT CPX terminal
- DC (distributed clocks), time-synchronised data transmission

Points to note in connection with CPX-CEC

When a bus node is combined with a control block (CPX-CEC, in the fieldbus remote controller operating mode), the connected I/Os and/or valves, sensors and actuators are controlled via the CPX control block.

In this case, the bus node only provides the communication interface to the PLC.

Communication between the control block and CPX bus node takes place by interlinking the CPX modules and takes

up the following address capacity in the CPX system:

- 8/16 byte outputs
- 8/16 byte inputs

The following address capacity remains in the control block or CPX system for activating the peripherals:

- 56/48 byte inputs
- 56/48 byte outputs

Data sheet – EtherCAT bus node

| General technical data | | | |
|---|--|--------|---|
| Type | CPX-FB37 | | |
| Fieldbus interface | 2x M12x1 socket, 4-pin, D-coded | | |
| Baud rate | [Mbps] | 100 | |
| Protocol | EtherCAT | | |
| Max. address capacity | Inputs | [byte] | 64 |
| | Outputs | [byte] | 64 |
| LED displays | Bus-specific | | Error = Communication error L/A1 = Network active port 1 L/A2 = Network active port 2 Run = Communication status |
| | Product-specific | | M = Modify, parameterisation PL = Load supply PS = Electronic supply, sensor supply SF = System fault |
| Device-specific diagnostics | <ul style="list-style-type: none"> Channel and module-oriented diagnostics Undervoltage of modules Diagnostic memory | | |
| Configuration support | ESI file | | |
| Parameterisation | <ul style="list-style-type: none"> System parameters Diagnostic behaviour Signal setup Fail-safe response Forcing of channels | | |
| Additional functions | <ul style="list-style-type: none"> System status can be displayed using process data Additional diagnostic interface for operator units Emergency message Acyclic data access via fieldbus Diagnostics object Compatibility mode with CPX-FB38 Modular device profile (MDP) Variable PDO mapping | | |
| Control elements | DIL switch | | |
| Operating voltage | Nominal value | [V DC] | 24 |
| | Permissible range | [V DC] | 18 ... 30 |
| Current consumption | | | Typically 100 |
| Degree of protection to EN 60529 | IP65, IP67 | | |
| Temperature range | Operation | [°C] | - 5... +50 |
| | Storage/transport | [°C] | -20 ... +70 |
| Materials | Housing | | PA-reinforced |
| Note on materials | RoHS-compliant | | |
| PWIS conformity | VDMA24364-B2-L | | |
| Grid dimension | [mm] | | 50 |
| Dimensions (including interlinking block) W x L x H | [mm] | | 50 x 107 x 50 |
| Product weight | [g] | | 125 |

 - **Note**

Please observe the general limits and guidelines for the system when configuring the electrical modules.

 - **Note**

Always use the correct screws for the interlinking block; this depends on whether the block is made of metal or plastic:

- Self-tapping screws for plastic interlinking blocks
- Screws with metric thread for metal interlinking blocks

Data sheet – EtherCAT bus node

Connection and display components

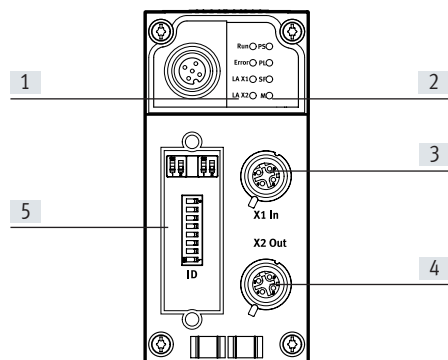





- [1] Bus-specific status LEDs
- [2] CPX-specific status LEDs
- [3] Fieldbus interface, input (socket M12x1, 4-pin, D-coded)
- [4] Fieldbus interface, output (socket M12x1, 4-pin, D-coded)
- [5] DIL switch

Pin allocation for the fieldbus interface

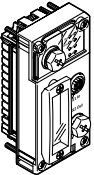
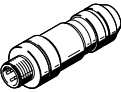
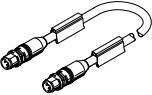
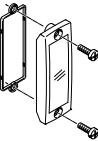
| Terminal allocation | Pin | Signal | Designation |
|------------------------------|---------|--------|-------------------|
| M12x1 socket, D-coded | | | |
| | 1 | TD+ | Transmitted data+ |
| | 2 | RD+ | Received data+ |
| | 3 | TD- | Transmitted data- |
| | 4 | RD- | Received data- |
| | Housing | FE | Shielding |

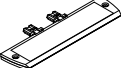
Data sheet – EtherCAT bus node

| Ordering data | | Part no. | Type | | |
|--|--|--------------------------------------|----------------------------|------------------|------------------------------|
| Designation | | | | | |
| Bus node | | | | | |
|  | EtherCAT bus node | 2735960 | CPX-FB37 | | |
| Bus connection | | | | | |
|  | Plug M12x1, 4-pin, D-coded | 543109 | NECU-M-S-D12G4-C2-ET | | |
|  | Connecting cable, straight plug, M12x1, 4-pin, D-coded | Straight plug, M12x1, 4-pin, D-coded | 0.5 m | 8040446 | NEBC-D12G4-ES-0.5-S-D12G4-ET |
| | | | 1 m | 8040447 | NEBC-D12G4-ES-1-S-D12G4-ET |
| | | | 3 m | 8040448 | NEBC-D12G4-ES-3-S-D12G4-ET |
| | | | 5 m | 8040449 | NEBC-D12G4-ES-5-S-D12G4-ET |
| | | | 10 m | 8040450 | NEBC-D12G4-ES-10-S-D12G4-ET |
| | | Straight plug, RJ45, 8-pin | 1 m | 8040451 | NEBC-D12G4-ES-1-S-R3G4-ET |
| | | | 3 m | 8040452 | NEBC-D12G4-ES-3-S-R3G4-ET |
| | | | 5 m | 8040453 | NEBC-D12G4-ES-5-S-R3G4-ET |
| Open end, 4-wire | 10 m | 8040454 | NEBC-D12G4-ES-10-S-R3G4-ET | | |
| 5 m | 8040456 | NEBC-LE4-ES-5-D12G4-ET | | | |
|  | Inspection cover, transparent | 533334 | AK-SUB-9/15-B | | |
|  | Cover cap for sealing unused bus connections (10 pieces) | 165592 | ISK-M12 | | |
|  | Inscription label holder for connection block | 536593 | CPX-ST-1 | | |
|  | 5-pin M12 to mini USB socket adapter and controller software | 547432 | NEFC-M12G5-0.3-U1G5 | | |
| User documentation | | | | | |
|  | Electronics manual, CPX bus node, type CPX-FB37 | German | 8029674 | P.BE-CPX-FB37-DE | |
| | | English | 8029675 | P.BE-CPX-FB37-EN | |
| | | Spanish | 8029676 | P.BE-CPX-FB37-ES | |
| | | French | 8029677 | P.BE-CPX-FB37-FR | |
| | | Italian | 8029678 | P.BE-CPX-FB37-IT | |
| | | Chinese | 8029679 | P.BE-CPX-FB37-ZH | |

Data sheet – Sercos III bus node

- Sercos
- Web interface

Bus node for handling communication between the electrical terminal CPX and the Sercos III network.

The bus node is provided with system supply via the interlinking block and processes communication with the I/O modules.

The status of the CPX terminal is displayed as a common message via 4 CPX-specific LEDs.

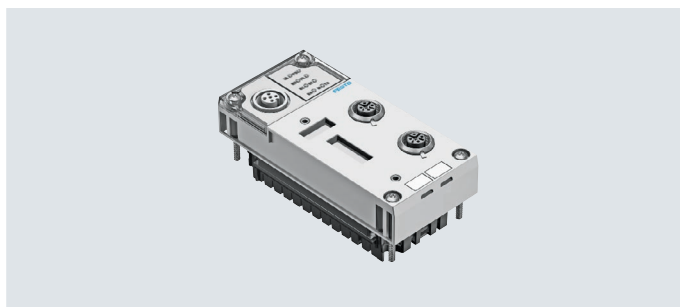

Application

Bus connection

The bus connection is established via two M12x1 plugs, D-coded to IEC 947-5-2 with degree of protection to IP65, IP67. The connections are equipped with automatic detection for the incoming and outgoing connection.

The Sercos III bus node can be used to connect the CPX valve terminal to the standardised Sercos III bus.

Sercos III uses the Ethernet standard (IEEE802.3) and TCP/IP technology for communication in an industrial environment.

Industry-compatible Sercos III devices enable data to be exchanged with a higher data transmission rate, such as data from sensors, actuators or controllers.

Non-real-time critical information, such as diagnostics or configuration information, can also be transferred.

Web servers

In addition to activation via a bus system, it is possible to use IT technologies. An integrated web server enables

diagnostic data to be visualised via HTML. Various programs support direct

access to the device data from the automation network.

Points to note in connection with CPX-CEC

The CPX-FB39 supports the operating modes remote I/O and remote controller.

In remote I/O operating mode, all functions of the CPX valve terminal are directly controlled by the Sercos controller.

When a bus node is combined with a control block (CPX-CEC, in the fieldbus

remote controller operating mode), the connected I/Os and/or valves, sensors and actuators are controlled via the CPX control block.

In this case, the bus node only provides the communication interface to the PLC.

Communication between the control block and CPX bus node takes place by

interlinking the CPX modules and takes up the following address capacity in the CPX system:

- 8/16 byte outputs
- 8/16 byte inputs

The following address capacity remains in the control block or CPX system for activating the peripherals:

- 56/48 byte inputs

- 56/48 byte outputs

Data sheet – Sercos III bus node

| General technical data | | | |
|---|---|----------------------|---|
| Type | CPX-FB39 | | |
| Fieldbus interface | 2x M12x1 socket, D-coded, 4-pin | | |
| Baud rate | [Mbps] | 100 full/half duplex | |
| Protocol | Sercos III | | |
| Max. address capacity | Inputs | [byte] | 64 |
| | Outputs | [byte] | 64 |
| LED displays | Bus-specific | | S = Sercos LED SD = Sercos sub-device LED TP1 = Network active port 1 TP2 = Network active port 2 |
| | Product-specific | | M = Modify, parameterisation PL = Load supply PS = Electronics supply, sensor supply SF = System fault |
| Device-specific diagnostics | | | |
| <ul style="list-style-type: none"> Module and channel-oriented diagnostics Undervoltage of modules Diagnostic memory | | | |
| Configuration support | SDDML file | | |
| Parameterisation | <ul style="list-style-type: none"> Diagnostic behaviour Fallback output data Forcing of channels Signal setup System parameters | | |
| Additional functions | <ul style="list-style-type: none"> Acyclic and cyclic data access via Sercos IP addressing via Sercos parameters or operator unit Channel-oriented diagnostics via fieldbus Start-up parameterisation in plain text via fieldbus System status can be displayed using process data Additional diagnostic interface for operator units | | |
| Control elements | DIL switch | | |
| Operating voltage | Nominal value | [V DC] | 24 |
| | Permissible range | [V DC] | 18 ... 30 |
| Current consumption at nominal voltage | | | [mA] Typically 100 |
| Degree of protection to EN 60529 | | | |
| IP65, IP67 | | | |
| Temperature range | Operation | [°C] | - 5... +50 |
| | Storage/transport | [°C] | -20 ... +70 |
| Materials | PA-reinforced | | |
| Note on materials | RoHS-compliant | | |
| PWIS conformity | VDMA24364-B2-L | | |
| Grid dimension | | | [mm] 50 |
| Dimensions (including interlinking block) W x L x H | | | [mm] 50 x 107 x 50 |
| Product weight | | | [g] 125 |

 **Note**

Please observe the general limits and guidelines for the system when configuring the electrical modules.

Data sheet – Sercos III bus node

Connection and display components

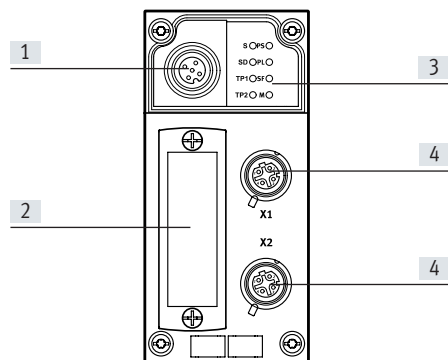

- [1] Service interface for PC with CPX maintenance tool NEFC-M12G5-0.3-U1G5
- [2] Transparent DIL switch cover
- [3] Status LED, bus-specific and CPX-specific
- [4] Fieldbus interface (M12x1 socket, 4-pin, D-coded)

Pin allocation for the fieldbus interface





| Terminal allocation | Pin | Signal | Designation |
|------------------------------|---------|--------|-------------------|
| M12x1 socket, D-coded | | | |
| | 1 | TD+ | Transmitted data+ |
| | 2 | RD+ | Received data+ |
| | 3 | TD- | Transmitted data- |
| | 4 | RD- | Received data- |
| | Housing | FE | Shielding |

**Note**

The CPX-FB39 can automatically detect transmitter and receiver cables (auto-MDI/MDI-X auto-crossover).

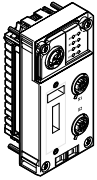
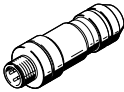
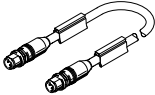
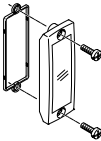
RD and TD signal pairs are automatically swapped if required.

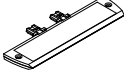
Data sheet – Sercos III bus node

| Ordering data | | Part no. | Type | | |
|--|---|--------------------------------------|----------------------------|---------------------------|------------------------------|
| Designation | | | | | |
| Bus node | | | | | |
|  | Ethernet Sercos III bus node | 2093101 | CPX-FB39 | | |
| Bus connection | | | | | |
|  | Plug M12x1, 4-pin, D-coded | 543109 | NECU-M-S-D12G4-C2-ET | | |
|  | Connecting cable, straight plug, M12x1, 4-pin, D-coded | Straight plug, M12x1, 4-pin, D-coded | 0.5 m | 8040446 | NEBC-D12G4-ES-0.5-S-D12G4-ET |
| | | | 1 m | 8040447 | NEBC-D12G4-ES-1-S-D12G4-ET |
| | | | 3 m | 8040448 | NEBC-D12G4-ES-3-S-D12G4-ET |
| | | | 5 m | 8040449 | NEBC-D12G4-ES-5-S-D12G4-ET |
| | | | 10 m | 8040450 | NEBC-D12G4-ES-10-S-D12G4-ET |
| | | | Straight plug, RJ45, 8-pin | 1 m | 8040451 |
| | 3 m | 8040452 | | NEBC-D12G4-ES-3-S-R3G4-ET | |
| | Open end, 4-wire | 5 m | 8040453 | NEBC-D12G4-ES-5-S-R3G4-ET | |
| 10 m | | 8040454 | NEBC-D12G4-ES-10-S-R3G4-ET | | |
| 5 m | 8040456 | NEBC-LE4-ES-5-D12G4-ET | | | |
| |  | Inspection cover, transparent | 533334 | AK-SUB-9/15-B | |
|  | Cover cap for sealing unused bus connections (10 pieces) | 165592 | ISK-M12 | | |
|  | Inscription label holder for connection block | 536593 | CPX-ST-1 | | |
|  | 5-pin M12 to mini USB socket adapter and controller software | 547432 | NEFC-M12G5-0.3-U1G5 | | |
| User documentation | | | | | |
|  | User documentation for bus node CPX-FB39 | German | 8028632 | P.BE-CPX-FB39-DE | |
| | | English | 8028633 | P.BE-CPX-FB39-EN | |
| | | Spanish | 8028634 | P.BE-CPX-FB39-ES | |
| | | French | 8028635 | P.BE-CPX-FB39-FR | |
| | | Italian | 8028636 | P.BE-CPX-FB39-IT | |
| | | Chinese | 8028637 | P.BE-CPX-FB39-ZH | |

Data sheet – POWERLINK bus node

- Ethernet POWERLINK
- Web interface

Bus node for handling communication between the electrical terminal CPX and the Ethernet POWERLINK network. The bus node is provided with system supply via the interlinking block and processes communication with the I/O modules.

The status of the CPX terminal is displayed as a common message via 4 CPX-specific LEDs.

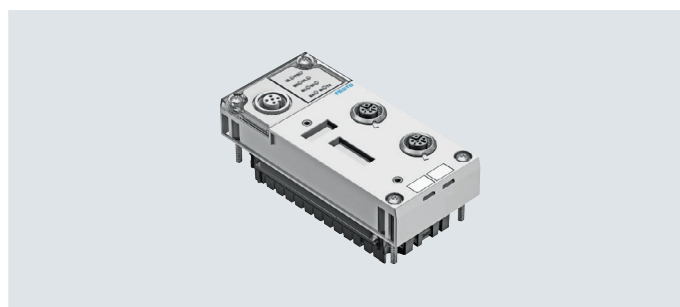

Application

Bus connection

The bus connection is established via an M12x1 plug, D-coded to IEC 947-5-2 with degree of protection IP65, IP67. Ethernet POWERLINK uses the Ethernet standards and TCP/IP technology (IEEE802.3) for communication in an industrial environment and integrates all CANopen mechanisms.

It includes all the key features of standard Ethernet, including internode communication, hotplug capability and free selection of network topology. Ethernet POWERLINK fulfils the real-time requirements using a mix of timeslot and polling procedures. In other words, defined times are re-

served on the Ethernet cable exclusively for transferring real-time data. Only network participants which have previously been prompted by the controller are able to transmit data during these timeslots.

Ethernet POWERLINK implementation

The CPX-FB40 supports the two operating modes: remote I/O and remote controller.

In remote I/O operating mode, all functions of the CPX valve terminal are di-

rectly controlled by the Ethernet POWERLINK master (host). In addition to activation via a bus system, it is possible to use IT technologies. An integrated web server enables diagnostic data to be visualised via

HTML. Various programs support direct access to the device data from the automation network.

The Ethernet POWERLINK node for CPX supports the transmission technology

that conforms to DIN EN 50173/CAT 5 as an integrated interface.

Points to note in connection with CPX-CEC

When a bus node is combined with a control block (CPX-CEC, in the fieldbus remote controller operating mode), the connected I/Os and/or valves, sensors and actuators are controlled via the CPX control block.

In this case, the bus node only provides the communication interface to the PLC.

Communication between the control block and CPX bus node takes place by interlinking the CPX modules and takes

up the following address capacity in the CPX system:

- 8 byte outputs
- 8 byte inputs

The following address capacity remains in the control block or CPX system for activating the peripherals:

- 56 byte inputs
- 56 byte outputs

Data sheet – POWERLINK bus node

| General technical data | | | |
|---|---|-----------------------|--|
| Type | CPX-FB40 | | |
| Fieldbus interface | 2x M12x1 socket, D-coded, 4-pin | | |
| Baud rate | [Mbps] | 100 | |
| Protocol | Ethernet PowerLink V2 | | |
| Max. address capacity | Inputs | [byte] | 64 |
| | Outputs | [byte] | 64 |
| LED displays | Bus-specific | | BE = POWERLINK error BS = POWERLINK status L/A1 = Link/activity port 1 L/A2 = Link/activity port 2 |
| | Product-specific | | M = Modify, parameterisation PL = Load supply PS = Electronic supply, sensor supply SF = System fault |
| Device-specific diagnostics | <ul style="list-style-type: none"> Module and channel-oriented diagnostics Undervoltage of modules Diagnostic memory | | |
| Configuration support | <ul style="list-style-type: none"> XDC file XDD file | | |
| Parameterisation | <ul style="list-style-type: none"> Diagnostic behaviour Fail-safe response Forcing of channels Signal setup System parameters | | |
| Additional functions | <ul style="list-style-type: none"> Acyclic data access via "SDO" and Ethernet Integrated hub IP addressing via DHCP, DIL switch or operator unit Channel-oriented diagnostics via fieldbus Start-up parameterisation in plain text via fieldbus System status can be displayed using process data Additional diagnostic interface for operator units | | |
| Control elements | DIL switch | | |
| Operating voltage | Nominal value | [V DC] | 24 |
| | Permissible range | [V DC] | 18 ... 30 |
| | Reverse polarity protection | For operating voltage | |
| Current consumption at nominal voltage | [mA] | Typically 100 | |
| Degree of protection to EN 60529 | IP65, IP67 | | |
| Temperature range | Operation | [°C] | - 5... +50 |
| | Storage/transport | [°C] | -20 ... +70 |
| Materials | PA-reinforced | | |
| Note on materials | RoHS-compliant | | |
| PWIS conformity | VDMA24364-B2-L | | |
| Grid dimension | [mm] | 50 | |
| Dimensions (including interlinking block) W x L x H | [mm] | 50 x 107 x 50 | |
| Product weight | [g] | 125 | |

 **Note**

Please observe the general limits and guidelines for the system when configuring the electrical modules.

Data sheet – POWERLINK bus node

Connection and display components

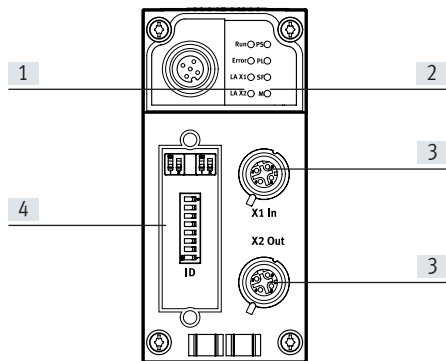



- [1] Bus-specific status LEDs
- [2] CPX-specific status LEDs
- [3] Fieldbus interface (M12x1 socket, 4-pin, D-coded)
- [4] Transparent DIL switch cover

Pin allocation for the fieldbus interface

| Terminal allocation | Pin | Signal | Designation |
|------------------------------|---------|--------|-------------------|
| M12x1 socket, D-coded | | | |
| | 1 | TD+ | Transmitted data+ |
| | 2 | RD+ | Received data+ |
| | 3 | TD- | Transmitted data- |
| | 4 | RD- | Received data- |
| | Housing | FE | Shielding |

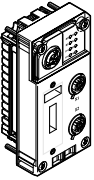
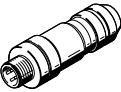
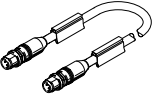
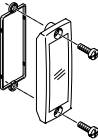
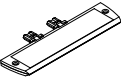
Data sheet – POWERLINK bus node

| Ordering data | | Part no. | Type | | |
|--|--|--------------------------------------|------------------------|----------------------------|------------------------------|
| Designation | | | | | |
| Bus node | | | | | |
|  | Ethernet POWERLINK bus node | 2474896 | CPX-FB40 | | |
| Bus connection | | | | | |
|  | Plug M12x1, 4-pin, D-coded | 543109 | NECU-M-S-D12G4-C2-ET | | |
|  | Connecting cable, straight plug, M12x1, 4-pin, D-coded | Straight plug, M12x1, 4-pin, D-coded | 0.5 m | 8040446 | NEBC-D12G4-ES-0.5-S-D12G4-ET |
| | | | 1 m | 8040447 | NEBC-D12G4-ES-1-S-D12G4-ET |
| | | | 3 m | 8040448 | NEBC-D12G4-ES-3-S-D12G4-ET |
| | | | 5 m | 8040449 | NEBC-D12G4-ES-5-S-D12G4-ET |
| | | | 10 m | 8040450 | NEBC-D12G4-ES-10-S-D12G4-ET |
| | | Straight plug, RJ45, 8-pin | 1 m | 8040451 | NEBC-D12G4-ES-1-S-R3G4-ET |
| | | | 3 m | 8040452 | NEBC-D12G4-ES-3-S-R3G4-ET |
| | | | 5 m | 8040453 | NEBC-D12G4-ES-5-S-R3G4-ET |
| | Open end, 4-wire | 10 m | 8040454 | NEBC-D12G4-ES-10-S-R3G4-ET | |
| | 5 m | 8040456 | NEBC-LE4-ES-5-D12G4-ET | | |
|  | Inspection cover, transparent | 533334 | AK-SUB-9/15-B | | |
|  | Inscription label holder for connection block | 536593 | CPX-ST-1 | | |
|  | 5-pin M12 to mini USB socket adapter and controller software | 547432 | NEFC-M12G5-0.3-U1G5 | | |
| User documentation | | | | | |
|  | User documentation for bus node CPX-FB40 | German | 8028650 | P.BE-CPX-FB40-DE | |
| | | English | 8028651 | P.BE-CPX-FB40-EN | |
| | | Spanish | 8028652 | P.BE-CPX-FB40-ES | |
| | | French | 8028653 | P.BE-CPX-FB40-FR | |
| | | Italian | 8028654 | P.BE-CPX-FB40-IT | |
| | | Chinese | 8028655 | P.BE-CPX-FB40-ZH | |

Data sheet – Interface for CPI system

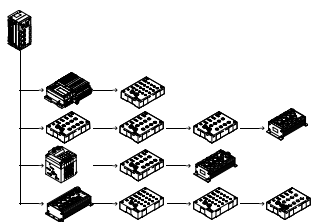

The electrical interface CPX-CP establishes the connection to CP modules of the installation system CPI via pre-assembled connecting cables. The I/O data of the connected valve terminals with CP string extension and CP input and output modules are transferred to the connected CPX bus node and thus via fieldbus to the higher-order controller.

This enables modular centralised and compact decentralised concepts to be established with one system.



Application

CP connection

As well as transmitting the communication data, the max. 4 CP strings of a CPX-CP interface also transmit the power supply to the connected sensors and the load supply to the valves (or outputs). Both circuits are supplied separately with 24 V but using a common reference potential.

The valve terminals with CP string extension (or outputs) are supplied with voltage for the electronics and valves by the interlinking block.

The CP interface allows the following combinations:

- Centralised analogue and digital inputs and outputs of the CPX terminal
- Decentralised digital inputs and outputs of the CP installation system
- Valve/valve terminals that can be connected both centrally and decentraly

Configuration example – CP interface with CP modules

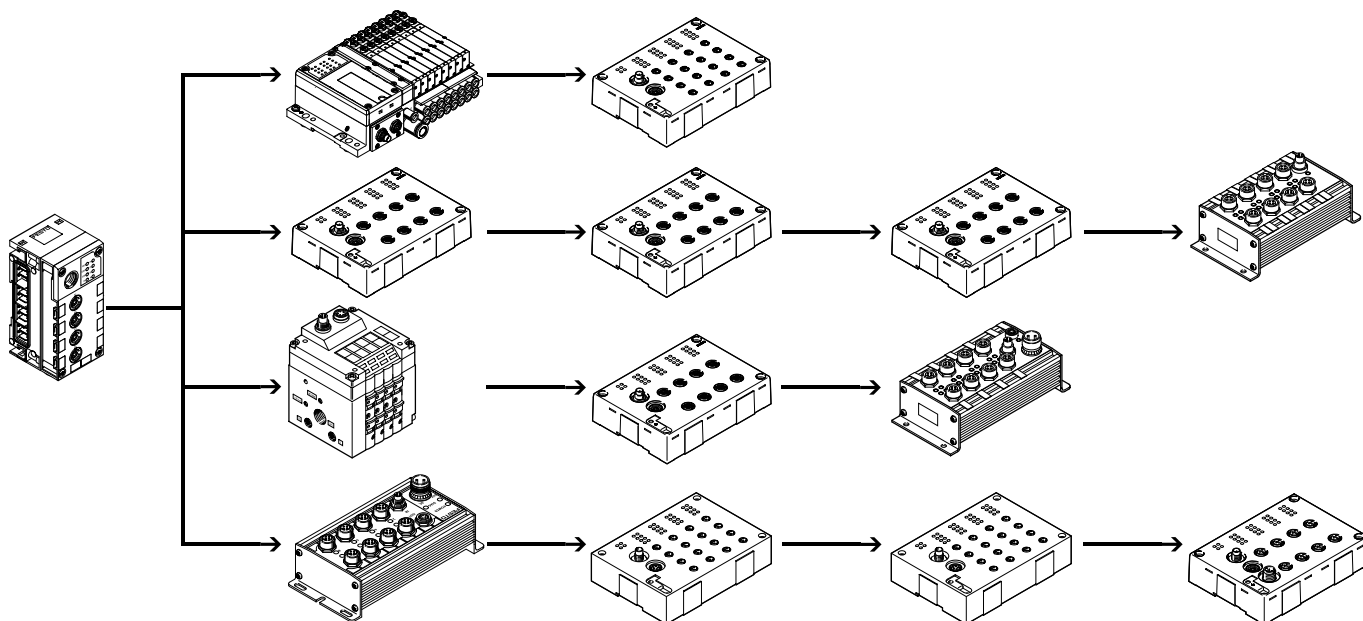

Data sheet – Interface for CPI system

Implementation

The CPX-CP interface supports the CPI system:

- Max. 4 individual electronically protected CP strings
- Max. 4 CP modules per string
- Max. 32 inputs/32 outputs per string
- The maximum length of a string is 10 m. If the CP interface is positioned centrally, the CP system can cover an area of 20 m in diameter.
- Modules with CPI functionality

The following CP module variants are available:

- Input modules with 8 or 16 digital inputs (connection technology M8, M12)
- Output modules with 4 or 8 digital outputs (connection technology M12)
- Valve terminals with CP string extension (up to 32 solenoid coils, different valve functions)

CPI modules support the following functions:

- Module-oriented diagnostics
- Module/channel-oriented parameterisation
- Support of all functions by the CPX-FMT
- Module can be positioned anywhere within the string

Several CP interface modules can be combined in one CPX terminal, depending on the address capacity of the bus node.

Example:

- CPX-FB13 (512 I/O)
- Max. 4 CP interface modules (128 I/O each) possible

 **Note**

When arranging the CP modules it should be taken into consideration that CP input modules without CPI functionality should always be placed at the end of a string.

Configuration

The following rules apply for a string of a CPX-CP interface:

- Max. one output module or one valve terminal without CPI functionality
- Max. one output module without CPI functionality or one valve terminal with CP string extension
- Any number of CP modules with CPI functionality, up to the maximum limit of 4 modules and/or 32 inputs/32 outputs per string

- Maximum extension:
- 4 input modules and 4 valve terminals/output modules without CPI functionality
- 16 CP modules with CPI functionality

The configuration of the strings with respect to the module type and position of the modules in the string is entered by activating the SAVE key in the CPX-CP interface and saved there permanently.

Saved data are retained even when the CP interface is isolated from the power supply.

The representation of the CP interface within a CPX terminal and thus at the fieldbus is dependent on the characteristics of the relevant fieldbus system. In addition to input and output addressing, this also applies to the representation of the diagnostics and parameterisation of the CP module and the characteristics of the CPI system.

 **Note**

The remanent saving of configuration data means that changes in the configuration or faulty modules are still displayed even after a voltage failure.

Data sheet – Interface for CPI system

| General technical data | | | |
|---|--|--------|---------------------------------|
| Type | CPX-CP-4-FB | | |
| Brief description | CP interface | | |
| Max. number of | CP strings | | 4 |
| | CP modules per string | | 4 |
| | Outputs per string | | 32 |
| | Inputs per string | | 32 |
| CP connection | Socket M9, 5-pin | | |
| Baud rate | | [kbps] | 1000 |
| Cycle time | CP modules without CPI functionality | [ms] | 4 |
| | CP modules with CPI functionality | [ms] | 2 |
| LED displays | L1 ... 4= Status of the CP string 1 ... 4 PS = Electronics supply, sensor supply PL = Load supply RN = Status of the CP system SF = System fault | | |
| Device-specific diagnostics | Via bus node | | |
| Operating voltage | Nominal value | [V DC] | 24 (reverse polarity protected) |
| | Permissible range | [V DC] | 18 ... 30 |
| | Power failure buffering | [ms] | 20 |
| Sensor supply voltage | | [V DC] | 24 ±25% coming from bus node |
| Actuator load voltage | | [V DC] | 24 ±10% coming from bus node |
| Current consumption | Without CP modules | [A] | Max. 0.2 |
| | Per CP string | [A] | Max. 1.6 |
| Degree of protection to EN 60529 | IP65, IP67 | | |
| Temperature range | Operation | [°C] | -5 ... +50 |
| | Storage/transport | [°C] | -20 ... +70 |
| Materials | PA | | |
| PWIS conformity | VDMA24364-B2-L | | |
| Grid dimension | | [mm] | 50 |
| Dimensions (including interlinking block) W x L x H | | [mm] | 50 x 107 x 45 |
| Product weight | | [g] | 139 |

 **Note**

Please observe the general limits and guidelines for the system when configuring the electrical modules.

Data sheet – Interface for CPI system

Connection and display components

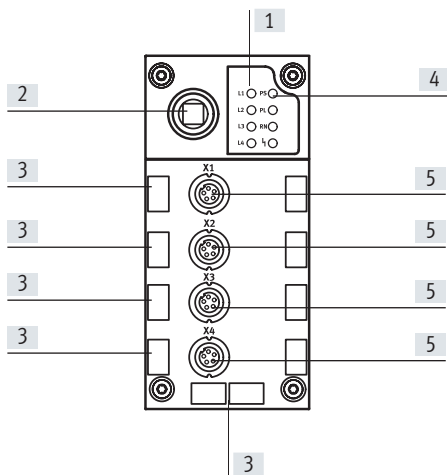

- [1] CP string LEDs
- [2] SAVE key
- [3] Holders for inscription labels (IBS 6x10)
- [4] CPX-specific status LEDs
- [5] CP connections for up to 4 strings (0 ... 3)



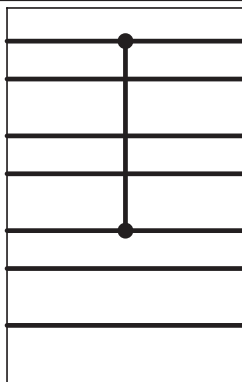

Power supply

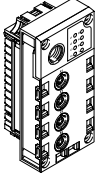

- 0V** Valves
- 24V** Valves
- 0V** Output
- 24V** Output
- 0V** El./Sen.
- 24V** El./Sen.
- FE**

The module combines the 0 V potential of the power supply for electronics and sensors with the 0 V potential of the power supply for valves.
 If all pins of the valves of a pneumatic interface connected to the right of the CP interface are to be switched off, an appropriate interlinking block with additional supply for valves must be used to the right of the CP interface.

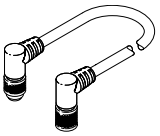
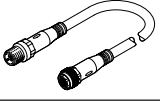
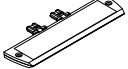
Data sheet – Interface for CPI system

| Ordering data | | Part no. | Type |
|---|---|----------|----------------------------|
| Designation | | | |
| CP interface | | | |
|  | Interface for max. 16 I/O modules and valve terminals of the CPI system | 526705 | CPX-CP-4-FB |
| Bus connection | | | |
|  | Cover cap | M12 | 165592 ISK-M12 |
|  | Connecting cable, angled plug, angled socket | 0.25 m | 540327 KVI-CP-3-WS-WD-0.25 |
| | | 0.5 m | 540328 KVI-CP-3-WS-WD-0.5 |
| | | 2 m | 540329 KVI-CP-3-WS-WD-2 |
| | | 5 m | 540330 KVI-CP-3-WS-WD-5 |
| | | 8 m | 540331 KVI-CP-3-WS-WD-8 |
|  | Connecting cable, straight plug, straight socket | 2 m | 540332 KVI-CP-3-GS-GD-2 |
| | | 5 m | 540333 KVI-CP-3-GS-GD-5 |
| | | 8 m | 540334 KVI-CP-3-GS-GD-8 |
|  | Inscription label holder for connection block | 536593 | CPX-ST-1 |
| User documentation | | | |
|  | User documentation for CPX-CP interface | German | 539293 P.BE-CPX-CP-EN |
| | | English | 539294 P.BE-CPX-CP-EN |
| | | Spanish | 539295 P.BE-CPX-CP-ES |
| | | French | 539296 P.BE-CPX-CP-FR |
| | | Italian | 539297 P.BE-CPX-CP-IT |

Data sheet – I-Port interface

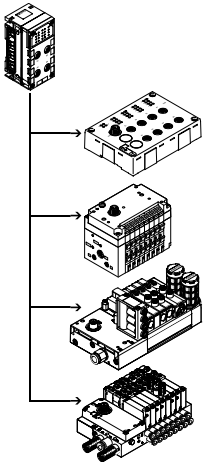

The electrical interface CPX CTEU master establishes the connection to modules of the CTEL/CTEU series that have an I-Port interface (device). The I/O data from the connected devices are transmitted to the connected CPX bus node and thus to the higher-order controller via fieldbus. A maximum of 4 devices can be connected to a CPX CTEU master via corresponding M12 interfaces.



Application

I-Port interface

As well as transmitting the communication data, the I-Port interfaces of a CPX CTEU master also transmit the power supply to the connected sensors and the load supply to the valves (or

outputs). Both circuits are supplied separately with 24 V, using a separate reference potential.

The connecting cables with a dual function as signal cable and supply ca-

ble must meet the corresponding increased requirements.

Configuration example – CPX CTEU master with CTEL modules

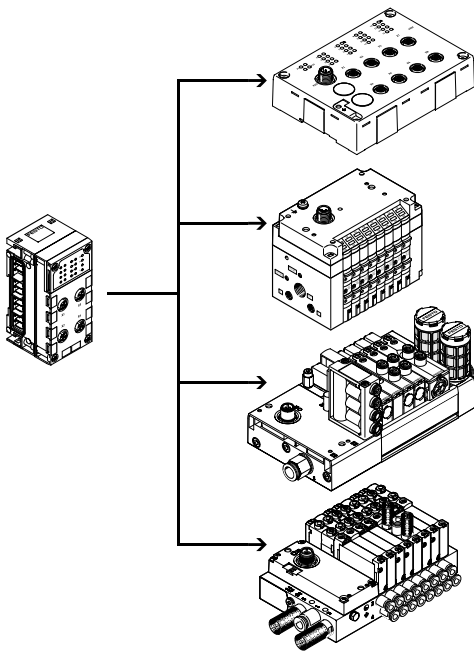

The CPX CTEU master provides 4 external I-Port interfaces, each of which can be connected to a device. I-Port is an interface for exchanging serial data for connecting decentralised modules or valve terminals from Festo. The I-Port interface is based on IO-Link and is compatible with it in certain areas. The connection type corresponds to a star topology. In other words, only one module or valve terminal can be connected to each I-Port.

The limitations with respect to IO-Link include:

- Permanently set baud rate of 230.4 kbps
- SIO mode is not supported
- Max. 32 bytes of input data and 32 bytes of output data
- Only one dump of the master commands is used
- Configuration via IO-DD is not supported.

Data sheet – I-Port interface

Implementation

The CPX CTEL master from Festo enables modules with an I-Port interface to be connected to a CPX system:

- Max. 4 devices with individual electronic protection
- Max. 64 inputs/64 outputs per I-Port interface
- The maximum length of a string is 20 m.

The following device variants are available:

- Input modules with 16 digital inputs (connection technology M8 3-pin and M12 5-pin)
- Valve terminals with I-Port interface (up to 48 solenoid coils, different valve functions)

The decentralised arrangement of the modules and valve terminals with I-Port enables them to be mounted close to the cylinders and actuators or sensors to be controlled. This means that the compressed air supply lines and sensor connecting cables used can be shortened, and it may be possible to use smaller valves, thereby saving costs.

Several CPX CTEL masters can be combined in one CPX terminal, depending on the address capacity of the bus node.

Example:

- CPX-FB13 (512 I/O)
- A maximum of 2 CPX CTEL masters is possible (each with 256 I/O)

Configuration

Settings

The exact amount of the I/O bytes made available depends on the requirements of the connected devices or of the correspondingly selected operating mode.

The operating mode or preset configuration of the CPX CTEL master can be specified by the user.

Selecting the operating mode and setting the manual configuration takes place via the DIL switches. These DIL switches are not required during continuous operation and are only accessible in the disassembled state.

Manual configuration

In the case of manual configuration (tool change mode), the volume of inputs and outputs in the process image of the CPX system or of the higher-order fieldbus can be defined manually using the DIL switches.

The process image then always has the same scope, regardless of the connected devices.

The I/O length specified always applies to all four I-Ports (max. 8 bytes per I-Port).

Automatic configuration

In the case of automatic configuration, the I/O length for each I-Port is determined individually and this value is used to select the appropriate or next highest configuration preset.

Power supply for I-Port devices

The CPX-CTEL master provides two separate power supplies for the connected devices:

- For operating the device and the inputs connected to it
- For the outputs and valves that are connected to the device

The power supply for the devices and the inputs is provided by the power supply for the electronics and sensors of the CPX terminal.

The power supply for the outputs and valves is provided by the power supply for the valves of the CPX terminal.

The interlinking block with additional supply ensures a separate supply voltage for the valves and outputs. This means it is possible to disconnect this supply voltage separately.

The valves and outputs of the connected I-Port devices can therefore be dis-

connected separately without disconnecting the devices.

Data sheet – I-Port interface

| General technical data | | | |
|--|---|-------------------------------|---------------------------------|
| Type | CPX-CTEL-4-M12-5POL | | |
| Protocol | I-Port | | |
| Max. address capacity | Outputs | [bit] | 256 |
| | Inputs | [bit] | 256 |
| I-Port connection | 4x socket M12, 5-pin, A-coded | | |
| Number of I-Port interfaces | 4 | | |
| Maximum cable length | [m] | | 20 |
| Internal cycle time | [ms] | | 1 per 8 bits of user data |
| Galvanic isolation | Channel – channel | No | |
| | Channel – internal bus | Yes, with intermediate supply | |
| LED displays | X1 ... 4 = Status of the I-Port interface 1 ... 4 PS = Electronic supply PL = Load supply  = Module error | | |
| Diagnostics | <ul style="list-style-type: none"> • Communication error • Module short circuit • Module-oriented diagnostics • Undervoltage | | |
| Parameterisation | <ul style="list-style-type: none"> • Diagnostic behaviour • Failsafe per channel • Forcing per channel • Idle mode per channel • Module parameters • Tool change mode | | |
| Additional functions | Tool change mode | | |
| Control elements | DIL switch | | |
| Operating voltage | Nominal value | [V DC] | 24 (reverse polarity protected) |
| | Permissible range | [V DC] | 18 ... 30 |
| | Power failure buffering | [ms] | 10 |
| Intrinsic current consumption at nominal operating voltage | [mA] | | Typically 65 |
| Max. power supply per channel | [A] | | 4x 1.6 |
| Max. residual current of outputs per channel | [A] | | 4x 1.6 |
| Degree of protection to EN 60529 | IP65, IP67 | | |
| Temperature range | Operation | [°C] | -5 ... +50 |
| | Storage/transport | [°C] | -20 ... +70 |
| Materials | Reinforced PA, PC | | |
| Note on materials | RoHS-compliant | | |
| PWIS conformity | VDMA24364-B2-L | | |
| Grid dimension | [mm] | | 50 |
| Dimensions (including interlinking block) W x L x H | [mm] | | 50 x 107 x 55 |
| Product weight | [g] | | 110 |

 - **Note**

Please observe the general limits and guidelines for the system when configuring the electrical modules.

Data sheet – I-Port interface

Connection and display components

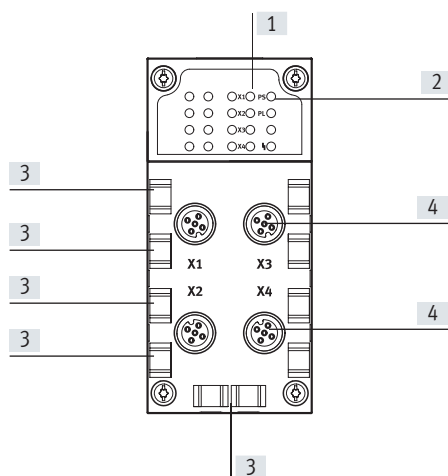

- [1] Status LEDs for I-Port interfaces
- [2] CPX-specific status LEDs
- [3] Holders for inscription labels (IBS 6x10)
- [4] I-Port interfaces for up to 4 devices

Combinations of bus nodes/control blocks with interface CPX-CTEL

| Bus node/control block | Part no. | Interface |
|------------------------|----------|---------------------|
| | | CPX-CTEL-4-M12-5POL |
| CPX-CEC-C1 | 567347 | ■ |
| CPX-CEC-C1-V3 | 3473128 | ■ |
| CPX-CEC-M1-V3 | 3472765 | ■ |
| CPX-CEC | 567346 | ■ |
| CPX-CEC-S1-V3 | 3472425 | ■ |
| CPX-FB11 | 526172 | ■ |
| CPX-FB13 | 195740 | ■ |
| CPX-FB14 | 526174 | ■ |
| CPX-FB23-24 | 526176 | ■ |
| CPX-FB36 | 1912451 | ■ |
| CPX-FB37 | 2735960 | ■ |
| CPX-FB39 | 2093101 | ■ |
| CPX-FB40 | 2474896 | ■ |
| CPX-FB43 | 8110369 | ■ |
| CPX-M-FB44 | 8110370 | ■ |
| CPX-M-FB45 | 8110371 | ■ |

Pin allocation – I-Port interface

| Terminal allocation | Pin | Signal | Designation |
|---------------------|-----|-----------------------|--|
| | 1 | 24 V _{SEN} | 24 V DC supply voltage for electronics and inputs |
| | 2 | 24 V _{VAL} | 24 V DC load voltage supply for valves and outputs |
| | 3 | 0 V _{SEN} | 0 V DC supply voltage for electronics and sensors |
| | 4 | C/Q _{I-Port} | Communication signal C/Q, data transmission line |
| | 5 | 0 V _{VALVES} | 0 V DC load voltage supply for valves and outputs |

Data sheet – I-Port interface



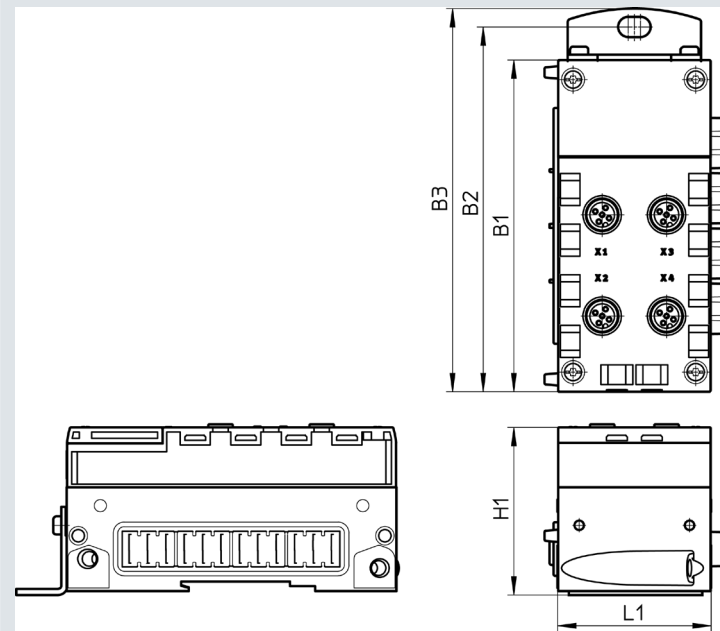

Dimensions

Download CAD data → www.festo.com

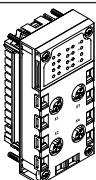

| Type | B1 | B2 | B3 | H1 | L1 |
|---------------------|-------|-------|-------|------|----|
| CPX-CTEL-4-M12-5POL | 108.1 | 118.9 | 124.9 | 55.1 | 50 |

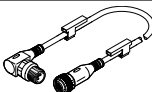
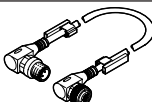
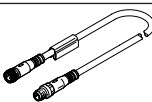
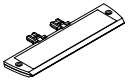
Data sheet – I-Port interface

| Ordering data | | Part no. | Type |
|---|--|---|--|
| Designation | | | |
| CPX-CTEL master | | | |
|  | Interface for a maximum of 4 I/O modules and valve terminals with I-Port interface (devices) | 1577012 | CPX-CTEL-4-M12-5POL |
| Bus connection | | | |
|  | Cover cap | M12 | 165592 ISK-M12 |
|  | Connecting cable M12-M12, 5-pin • Straight socket • Angled plug | Cable characteristic: standard | 0.5 m 8003617 NEBU-M12G5-K-0.5-M12W5 |
| | | | 2 m 8003618 NEBU-M12G5-K-2-M12W5 |
|  | Connecting cable M12-M12, 5-pin • Angled socket • Angled plug | Cable characteristic: standard | 0.5 m 570733 NEBU-M12W5-K-0.5-M12W5 |
| | | | 2 m 570734 NEBU-M12W5-K-2-M12W5 |
|  | Connecting cable M12-M12, 5-pin • Straight socket • Straight plug | Cable characteristic: suitable for use with energy chains | 5 m 574321 NEBU-M12G5-E-5-Q8N-M12G5 |
| | | | 7.5 m 574322 NEBU-M12G5-E-7.5-Q8N-M12G5 |
| | | | 10 m 574323 NEBU-M12G5-E-10-Q8N-M12G5 |
|  | Inscription label holder for connection block | | 536593 CPX-ST-1 |
| User documentation | | | |
|  | User documentation CPX-CTEL master | German | 574600 P.BE-CPX-CTEL-DE |
| | | English | 574601 P.BE-CPX-CTEL-EN |
| | | Spanish | 574602 P.BE-CPX-CTEL-ES |
| | | French | 574603 P.BE-CPX-CTEL-FR |
| | | Italian | 574604 P.BE-CPX-CTEL-IT |

Data sheet – IO-Link interface

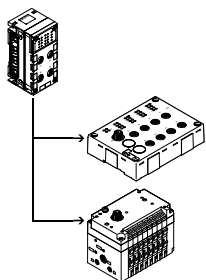

The electrical interface CPX-CTEL-2-... enables the connection of modules with IO-Link interface (IO-Link device) to the CPX terminal. The I/O data from the connected devices are transmitted to the connected CPX bus node and thus to the higher-order controller via fieldbus.
 A maximum of two IO-Link devices can be connected to an electrical interface CPX-CTEL-2-... via the corresponding M12 interfaces.



Application

The communication system IO-Link is used to exchange serial data from decentralised function modules (devices) at the field level.
 The electrical interface CPX-CTEL-2-... provides two external IO-Link interfaces,

each of which can be connected to a device.
 The connection type corresponds to a star topology, which means that only one device can be connected to each port.

The address space that the module makes available and assigns accordingly in the CPX system can be configured according to various presettings. Selecting the operating mode and setting the manual configuration takes place via the DIL switches.

These DIL switches are not required during continuous operation and are only accessible in the disassembled state.

Restrictions

The interfaces (ports) of electrical interface CPX-CTEL-2-... support the connection of IO-Link devices with few limitations.

- The process data length of the inputs and outputs is limited to 16 bytes each per port
- The driver strength on the C/Q line is limited to 250 mA
- SIO mode is not supported

Power supply for devices

The electrical interface CPX-CTEL-2-... provides two separate power supplies for the connected devices:
 • For operating the device and the inputs connected to it
 • For the outputs and valves that are connected to the device
 The power supply for the devices and the inputs is provided by the power

supply for the electronics and sensors of the CPX terminal.
 The power supply for the outputs and valves is provided by the power supply for the valves of the CPX terminal.
 The interlinking block with additional supply ensures a separate supply voltage for the valves and outputs. This

means it is possible to disconnect this supply voltage separately.
 The valves and outputs of the connected I-Port devices can therefore be disconnected separately without disconnecting the devices.

Data sheet – IO-Link interface

| General technical data | | | |
|--|---|-------------------------------|---------------------------------|
| Type | CPX-CTEL-2-M12-5POL-LK | | |
| Protocol | IO-Link, master version V 1.0 | | |
| Max. address capacity | Outputs | [bit] | 256 |
| | Inputs | [bit] | 256 |
| I-Port connection | 2x socket M12, 5-pin, A-coded | | |
| Number of IO-Link interfaces | 2 | | |
| Maximum cable length | [m] | 20 | |
| Internal cycle time | [ms] | 1 per 8 bits of user data | |
| Galvanic isolation | Channel – channel | No | |
| | Channel – internal bus | Yes, with intermediate supply | |
| LED displays | X1 ... 2 = Status of the IO-Link interface 1 ... 2 PS = Electronic supply PL = Load supply - L - = Module error | | |
| Diagnostics | <ul style="list-style-type: none"> • Communication error • Module short circuit • Module-oriented diagnostics • Undervoltage | | |
| Parameterisation | <ul style="list-style-type: none"> • Diagnostic behaviour • Failsafe per channel • Forcing per channel • Idle mode per channel • Module parameters | | |
| Additional functions | – | | |
| Control elements | DIL switch | | |
| Operating voltage | Nominal value | [V DC] | 24 (reverse polarity protected) |
| | Permissible range | [V DC] | 18 ... 30 |
| | Power failure buffering | [ms] | 10 |
| Intrinsic current consumption at nominal operating voltage | [mA] | Typically 65 | |
| Max. power supply per channel | [A] | 2x 1.6 | |
| Max. residual current of outputs per channel | [A] | 2x 1.6 | |
| Degree of protection to EN 60529 | IP65, IP67 | | |
| Temperature range | Operation | [°C] | –5 ... +50 |
| | Storage/transport | [°C] | –20 ... +70 |
| Materials | Reinforced PA, PC | | |
| Note on materials | RoHS-compliant | | |
| PWIS conformity | VDMA24364-B2-L | | |
| Grid dimension | [mm] | 50 | |
| Dimensions (including interlinking block) W x L x H | [mm] | 50 x 107 x 55 | |
| Product weight | [g] | 110 | |

**Note**

Please observe the general limits and guidelines for the system when configuring the electrical modules.

Data sheet – IO-Link interface

Connection and display components

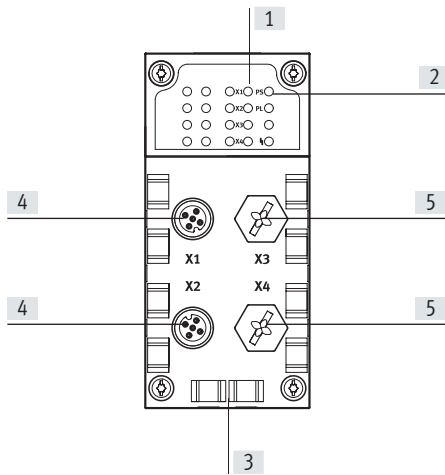

- [1] Status LEDs for I-Port interfaces
- [2] CPX-specific status LEDs
- [3] Holders for inscription labels (IBS 6x10)
- [4] IO-Link interfaces for up to 2 devices
- [5] Unused connections

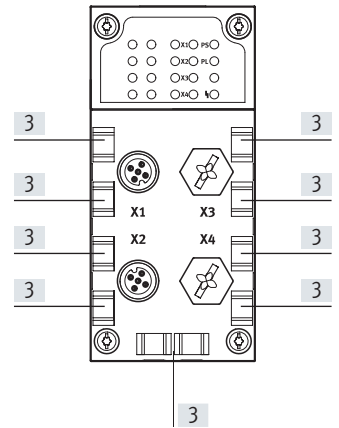

Combinations of bus nodes/control blocks with interface CPX-CTEL-2

| Bus node/control block | Part no. | Interface |
|------------------------|----------|------------------------|
| | | CPX-CTEL-2-M12-5POL-LK |
| CPX-CEC-C1-V3 | 3473128 | ■ |
| CPX-CEC-M1-V3 | 3472765 | ■ |
| CPX-CEC-S1-V3 | 3472425 | ■ |
| CPX-FB36 | 1912451 | ■ |
| CPX-FB39 | 2093101 | ■ |
| CPX-FB43 | 8110369 | ■ |
| CPX-M-FB44 | 8110370 | ■ |
| CPX-M-FB45 | 8110371 | ■ |

Pin allocation of IO-Link interface

| Terminal allocation | Pin | Signal | Designation |
|---------------------|-----|-----------------------|--|
| | 1 | 24 V _{SEN} | 24 V DC supply voltage for electronics and inputs |
| | 2 | 24 V _{VAL} | 24 V DC load voltage supply for valves and outputs |
| | 3 | 0 V _{SEN} | 0 V DC supply voltage for electronics and sensors |
| | 4 | C/Q _{I-Port} | Communication signal C/Q, data transmission line |
| | 5 | 0 V _{VALVES} | 0 V DC load voltage supply for valves and outputs |



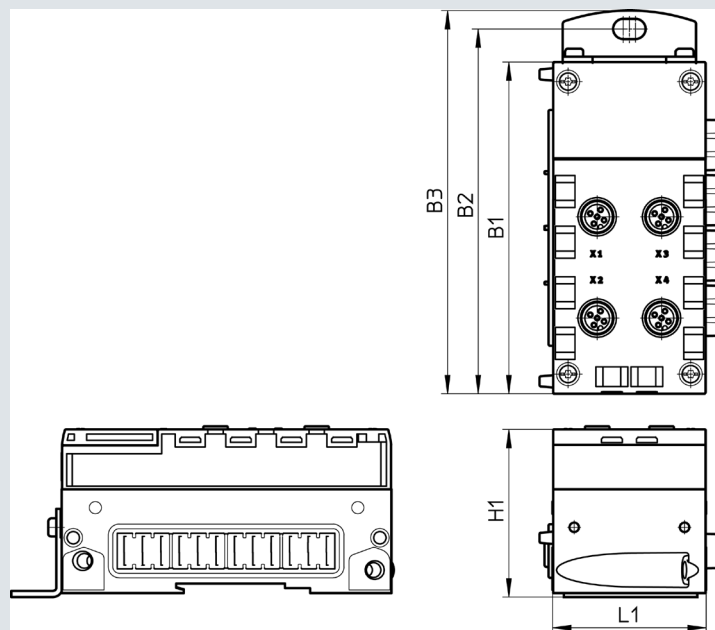

Data sheet – IO-Link interface

Dimensions

Download CAD data → www.festo.com

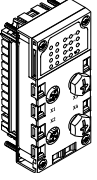
| Type | B1 | B2 | B3 | H1 | L1 |
|------------------------|-------|-------|-------|------|----|
| CPX-CTEL-2-M12-5POL-LK | 108.1 | 118.9 | 124.9 | 55.1 | 50 |

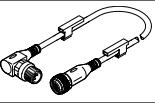
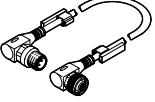
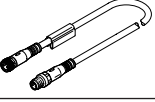
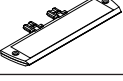
Data sheet – IO-Link interface

| Ordering data | | | | Part no. | Type |
|--|---|---|-------|----------------|-----------------------------------|
| CPX CTEL master, IO-Link | | | | | |
|  | Interface for max. 2 I/O modules and valve terminals with IO-Link interface (devices) | | | 2900543 | CPX-CTEL-2-M12-5POL-LK |
| Bus connection | | | | | |
|  | Cover cap | M12 | | 165592 | ISK-M12 |
|  | Connecting cable M12-M12, 5-pin • Straight socket • Angled plug | Cable characteristic: standard | 0.5 m | 8003617 | NEBU-M12G5-K-0.5-M12W5 |
| | | | 2 m | 8003618 | NEBU-M12G5-K-2-M12W5 |
|  | Connecting cable M12-M12, 5-pin • Angled socket • Angled plug | Cable characteristic: standard | 0.5 m | 570733 | NEBU-M12W5-K-0.5-M12W5 |
| | | | 2 m | 570734 | NEBU-M12W5-K-2-M12W5 |
|  | Connecting cable M12-M12, 5-pin • Straight socket • Straight plug | Cable characteristic: suitable for use with energy chains | 5 m | 574321 | NEBU-M12G5-E-5-Q8N-M12G5 |
| | | | 7.5 m | 574322 | NEBU-M12G5-E-7.5-Q8N-M12G5 |
| | | | 10 m | 574323 | NEBU-M12G5-E-10-Q8N-M12G5 |
|  | Inscription label holder for connection block | | | 536593 | CPX-ST-1 |
| User documentation | | | | | |
|  | User documentation CPX CTEL master | German | | 8034115 | P.BE-CPX-CTEL-LK-DE |
| | | English | | 8034116 | P.BE-CPX-CTEL-LK-EN |
| | | Spanish | | 8034117 | P.BE-CPX-CTEL-LK-ES |
| | | French | | 8034118 | P.BE-CPX-CTEL-LK-FR |
| | | Italian | | 8034119 | P.BE-CPX-CTEL-LK-IT |
| | | Swedish | | 8034120 | P.BE-CPX-CTEL-LK-ZH |

Data sheet – Axis controller for 4 electric axes

The control block CPX-CM-HPP is a module in the CPX terminal for controlling electric drives.

The control component is independent of the bus node used.

This means that Festo's electric drive technology is compatible with all industrial communication interfaces.

The control block does not need to be programmed.

- Max. 4 individual electric axes can be controlled via CAN bus
- No programming required
- Standardised communication with the drives via the Festo Handling and Positioning Profile (FHPP)
- Quick configuration and diagnostics via CPX-FMT
- Simple, flexible and cost-effective

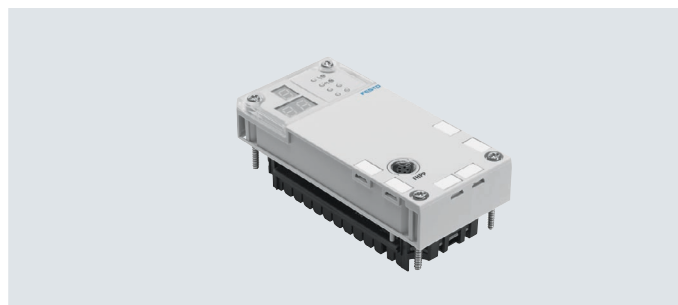

| General technical data | | |
|--|--------|---|
| Fieldbus interface | | 1x socket M9, 5-pin |
| Protocol | | FHPP |
| Max. address capacity inputs | [byte] | 32 |
| Max. address volume for outputs | [byte] | 32 |
| LED display (product-specific) | | Error: Fault PL: Power supply |
| Device-specific diagnostics | | Diagnostic memory Channel and module-oriented diagnostics Undervoltage/short circuit of modules |
| Parameterisation | | Forcing of channels System parameters |
| Configuration support | | Operator unit CPX-MMI |
| Total number of axes | | 4 |
| Nominal operating voltage | [V DC] | 24 |
| Operating voltage range | [V DC] | 18 ... 30 |
| Power failure buffering | [ms] | 10 |
| Intrinsic current consumption at nominal operating voltage | [mA] | Typically 80 |
| Degree of protection to EN 60529 (with plug inserted) | | IP65/IP67 |
| Dimensions W x L x H (including interlinking block) | [mm] | 50 x 107 x 55 |
| Product weight (without interlinking block) | [g] | 140 |
| Materials | | |
| Housing | | PA-reinforced PC |
| Note on materials | | RoHS-compliant |
| PWIS conformity | | VDMA24364-B2-L |
| Technical data – Interfaces | | |
| Interface | | |
| Control interface | | CAN bus |
| Baud rate | [Mbps] | 1 |
| Operating and environmental conditions | | |
| Ambient temperature | [°C] | -5 ... +50 |
| Storage temperature | [°C] | -20 ... +70 |
| CE marking (see declaration of conformity) | | To EU Low Voltage Directive |

Data sheet – Axis controller for 4 electric axes

Connection and display components

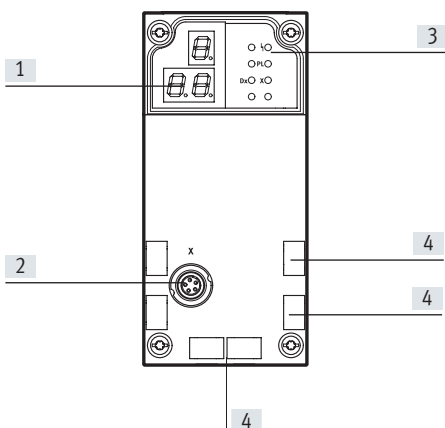

- [1] 3-digit display
- [2] Control interface
- [3] LED display (product-specific)
- [4] Inscription labels



Pin allocation – Control interface

| | Pin | Signal | Meaning |
|-------------------------|---------|-----------|---|
| Socket M9, 5-pin | | | |
| | 1 | n.c. | Not connected |
| | 2 | n.c. | Not connected |
| | 3 | CAN_GND | CAN ground |
| | 4 | CAN_H | CAN high |
| | 5 | CAN_L | CAN low |
| | Housing | Shielding | Cable shield must be connected to functional earth (FE) |

Permitted bus nodes/CEC

| Bus node/CEC | Protocol | Max. number of CPX-CM-HPP modules |
|--------------|-------------------|-----------------------------------|
| CPX-CEC... | – | 0 |
| CPX-FB11 | DeviceNet | 2 |
| CPX-FB13 | PROFIBUS | 2 |
| CPX-FB14 | CANopen | 1 |
| CPX-FB23-24 | CC-Link | 1 (as function module F23) |
| | | 0 (as function module F24) |
| CPX-FB36 | EtherNet/IP | 2 |
| CPX-FB37 | EtherCAT | 2 |
| CPX-FB39 | Sercos III | 2 |
| CPX-FB40 | POWERLINK | 2 |
| CPX-FB43 | PROFINET RT, M12 | 2 |
| CPX-M-FB44 | PROFINET RT, RJ45 | 2 |
| CPX-M-FB45 | PROFINET RT, SCRJ | 2 |

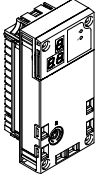
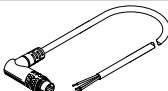
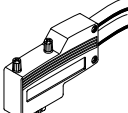
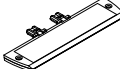
Data sheet – Axis controller for 4 electric axes

| Ordering data – Bus connection | | | | |
|---|---|---------|---------------|----------------------------|
| Designation | | | Part no. | Type |
| Control block | | | | |
|  | For actuating up to 4 electric drives via CAN bus | | 562214 | CPX-CM-HPP |
| Connecting cable | | | | |
|  | Connecting cable | 2 m | 563711 | NEBC-M9W5-K-2-N-LE3 |
| | | 5 m | 563712 | NEBC-M9W5-K-5-N-LE3 |
|  | Plug for CAN bus interface; Sub-D, 9-pin, without terminating resistor | | 533783 | FBS-SUB-9-WS-CO-K |
| Inscription labels | | | | |
|  | Inscription label holder for connection block | | 536593 | CPX-ST-1 |
| User documentation | | | | |
|  | Manual – Control block CPX-CM-HPP | German | 568683 | CPX-CM-HPP-DE |
| | | English | 568684 | CPX-CM-HPP-EN |

Data sheet – Axis controller for 1 electric axis

The axis controller CPX-CMAX is intended exclusively for use in valve terminals CPX.

General technical data
Operating voltage

| | | |
|--|--------|------------|
| Operating voltage range | [V DC] | 18 ... 30 |
| Nominal operating voltage | [V DC] | 24 |
| Current consumption at nominal operating voltage | [mA] | 200 |
| Fuse protection (short circuit) | | Electronic |
| Power failure buffering | [ms] | 10 |

Load voltage

| | | |
|---------------------------------|--------|------------|
| Load voltage range | [V DC] | 20 ... 30 |
| Nominal load voltage | [V DC] | 24 |
| Permissible load current | [A] | 2.5 |
| Fuse protection (short circuit) | | Electronic |

| | | | |
|------------------------------------|---------|-----------------------------|-----|
| Number of axis strings | | 1 | |
| Axes per string | | 1 | |
| Length of connecting cable to axis | [m] | ≤ 30 | |
| Max. number of modules | | 7 | |
| Display | | 7-segment display | |
| Assigned addresses | Outputs | [bit] | 8x8 |
| | Inputs | [bit] | 8x8 |
| Operating modes | | Record mode | |
| | | Direct mode | |
| Controller types | | Position control | |
| | | Force control | |
| Diagnostics | | Module-orientated | |
| | | Via local 7-segment display | |
| Status indication | | Module status | |
| | | Power load | |
| | | Display/Error Axis X | |
| | | MC Axis X | |

Control interface

| | | |
|-----------------------|--|-----------------------------|
| Data | | CAN bus with Festo protocol |
| | | Digital |
| Electrical connection | | 5-pin |
| | | M9 |
| | | Socket |

| | | | |
|--------------------|--------|----------------|-----|
| Materials: Housing | | PA-reinforced | |
| Note on materials | | RoHS-compliant | |
| PWIS conformity | | VDMA24364-B2-L | |
| Product weight | [g] | 240 | |
| Dimensions | Length | [mm] | 107 |
| | Width | [mm] | 50 |
| | Height | [mm] | 55 |

Data sheet – Axis controller for 1 electric axis

| Operating and environmental conditions | | |
|--|------|--------------------------|
| Ambient temperature | [°C] | -5 ... +50 |
| Relative humidity | [%] | 5 ... 95, non-condensing |
| Degree of protection to IEC 60529 | | IP65 |

Connection and display components

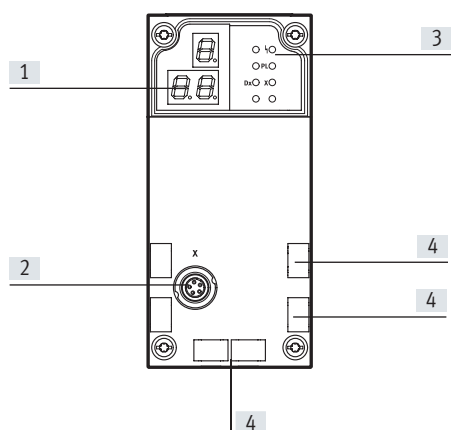

- [1] 3-digit display
- [2] Control interface
- [3] Status LEDs
- [4] Inscription labels

Pin allocation – Control interface

| | Pin | Signal | Designation |
|--|---------|-----------|---------------------------|
| | 1 | +24 V | Nominal operating voltage |
| | 2 | +24 V | Load voltage |
| | 3 | 0 V | Ground |
| | 4 | CAN_H | CAN high |
| | 5 | CAN_L | CAN low |
| | Housing | Shielding | Cable shielding |



Permitted bus nodes/CEC

| Bus node/CEC | Protocol | Max. number of CMAX modules |
|--------------|-------------------------|-----------------------------|
| CPX-CEC... | - | 8 |
| CPX-FB11 | DeviceNet ¹⁾ | 8 |
| CPX-FB13 | PROFIBUS ²⁾ | 8 |
| CPX-FB14 | CANopen | 4 |
| CPX-FB23-24 | CC-Link | 4 (as function module F23) |
| | | 8 (as function module F24) |
| CPX-FB36 | EtherNet/IP | 8 |
| CPX-FB37 | EtherCAT | 8 |
| CPX-FB39 | Sercos III | 8 |
| CPX-FB40 | POWERLINK | 8 |
| CPX-FB43 | PROFINET RT, M12 | 8 |
| CPX-M-FB44 | PROFINET RT, RJ45 | 8 |
| CPX-M-FB45 | PROFINET RT, SCRJ | 8 |

1) As of revision 20 (R20)

2) As of revision 23 (R23)

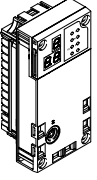
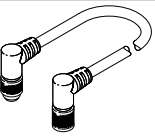
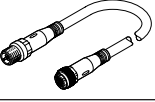
Data sheet – Axis controller for 1 electric axis

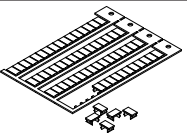
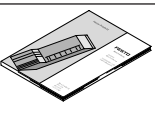
| Ordering data | | Brief description | Part no. | Type |
|--|---|-------------------|----------|----------------------|
| Axis controller | | | | |
|  | Order code in the CPX configurator: T21 | | 548932 | CPX-CMAX-C1-1 |
| Connecting cables | | | | |
|  | Connecting cable with angled plug and angled socket | 0.25 m | 540327 | KVI-CP-3-WS-WD-0.25 |
| | | 0.5 m | 540328 | KVI-CP-3-WS-WD-0.5 |
| | | 2 m | 540329 | KVI-CP-3-WS-WD-2 |
| | | 5 m | 540330 | KVI-CP-3-WS-WD-5 |
| | | 8 m | 540331 | KVI-CP-3-WS-WD-8 |
|  | Connecting cable with straight plug and straight socket | 2 m | 540332 | KVI-CP-3-GS-GD-2 |
| | | 5 m | 540333 | KVI-CP-3-GS-GD-5 |
| | | 8 m | 540334 | KVI-CP-3-GS-GD-8 |
|  | Connecting component for cabinet through feed | | 543252 | KVI-CP-3-SSD |
| Screws | | | | |
|  | For mounting on the metal interlinking block | | 550219 | CPX-M-M3X22-4X |
| Inscription labels | | | | |
|  | Inscription labels 6x10, in frames | 64 pieces | 18576 | IBS-6x10 |
| User documentation | | | | |
|  | Manual – Axis controller CPX-CMAX ¹⁾ | German | 559750 | P.BE-CPX-CMAX-SYS-DE |
| | | English | 559751 | P.BE-CPX-CMAX-SYS-EN |
| | | Spanish | 559752 | P.BE-CPX-CMAX-SYS-ES |
| | | French | 559753 | P.BE-CPX-CMAX-SYS-FR |
| | | Italian | 559754 | P.BE-CPX-CMAX-SYS-IT |

1) User documentation in paper form is not included in the scope of delivery.

Data sheet – End-position controller

The end-position controller CPX-CMPX is intended exclusively for use in valve terminals CPX.

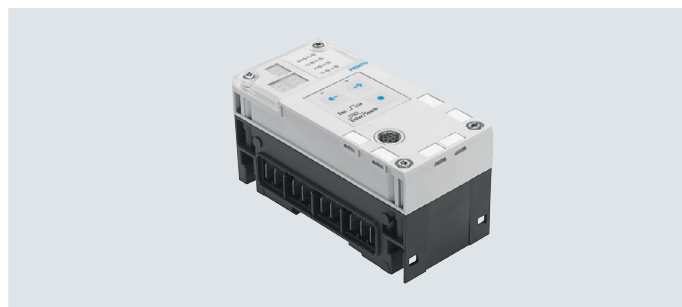

General technical data

| Operating voltage | | | |
|--|---------|-------|-----------------------------|
| Operating voltage range | [V DC] | | 18 ... 30 |
| Nominal operating voltage | [V DC] | | 24 |
| Current consumption at nominal operating voltage | [mA] | | 80 |
| Load voltage | | | |
| Load voltage range | [V DC] | | 20 ... 30 |
| Nominal load voltage | [V DC] | | 24 |
| Permissible load current | [A] | | 2.5 |
| Number of axes per module | | | 1 |
| Length of connecting cable to axis | [m] | | ≤ 30 |
| Max. number of modules | | | 9 |
| Display | | | 7-segment display |
| Control elements | | | 3 buttons |
| Assigned addresses | Outputs | [bit] | 6x8 |
| | Inputs | [bit] | 6x8 |
| Diagnostics | | | Module-orientated |
| | | | Via local 7-segment display |
| Status indication | | | Module status |
| | | | Power load |
| Control interface | | | |
| Data | | | CAN bus with Festo protocol |
| | | | Digital |
| Electrical connection | | | 5-pin |
| | | | M9 |
| | | | Socket |
| Materials: Housing | | | PA-reinforced |
| PWIS conformity | | | VDMA24364-B2-L |
| Product weight | [g] | | 140 |
| Dimensions | Length | [mm] | 107 |
| | Width | [mm] | 50 |
| | Height | [mm] | 55 |

Data sheet – End-position controller

Operating and environmental conditions

| | | |
|--|------|--------------------------|
| Ambient temperature | [°C] | -5 ... +50 |
| Relative humidity | [%] | 5 ... 95, non-condensing |
| Degree of protection to IEC 60529 | | IP65 |
| CE marking (see declaration of conformity) | | To EU EMC Directive |

Connection and display components

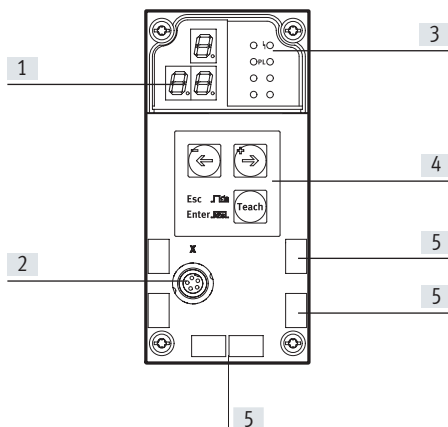

- [1] 3-digit display
- [2] Control interface
- [3] Status LEDs
- [4] Operating buttons
- [5] Inscription labels

Pin allocation – Control interface



| | Pin | Signal | Designation |
|--|---------|-----------|---------------------------|
| | 1 | +24 V | Nominal operating voltage |
| | 2 | +24 V | Load voltage |
| | 3 | 0 V | Ground |
| | 4 | CAN_H | CAN high |
| | 5 | CAN_L | CAN low |
| | Housing | Shielding | Cable shielding |

Permitted bus nodes/CEC

| Bus node/CEC | Protocol | Max. no. of CMPX modules |
|--------------|-------------------------|----------------------------|
| CPX-CEC... | - | 9 |
| CPX-FB11 | DeviceNet ¹⁾ | 9 |
| CPX-FB13 | PROFIBUS ²⁾ | 9 |
| CPX-FB14 | CANopen | 5 |
| CPX-FB23-24 | CC-Link | 5 (as function module F23) |
| | | 9 (as function module F24) |
| CPX-FB36 | EtherNet/IP | 9 |
| CPX-FB37 | EtherCAT | 9 |
| CPX-FB39 | Sercos III | 9 |
| CPX-FB40 | POWERLINK | 9 |
| CPX-FB43 | PROFINET RT, M12 | 9 |
| CPX-M-FB44 | PROFINET RT, RJ45 | 9 |
| CPX-M-FB45 | PROFINET RT, SCRJ | 9 |

1) As of revision 20 (R20)
 2) As of revision 23 (R23)

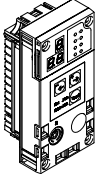
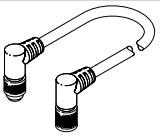
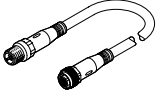
Data sheet – End-position controller

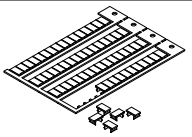
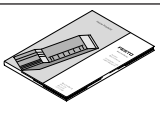
| Ordering data | | Brief description | Part no. | Type |
|---|---|-------------------|----------|----------------------|
| End-position controller | | | | |
|  | Order code in the CPX configurator: T20 | | 548931 | CPX-CMPX-C-1-H1 |
| Connecting cables | | | | |
|  | Connecting cable with angled plug and angled socket | 0.25 m | 540327 | KVI-CP-3-WS-WD-0.25 |
| | | 0.5 m | 540328 | KVI-CP-3-WS-WD-0.5 |
| | | 2 m | 540329 | KVI-CP-3-WS-WD-2 |
| | | 5 m | 540330 | KVI-CP-3-WS-WD-5 |
| | | 8 m | 540331 | KVI-CP-3-WS-WD-8 |
|  | Connecting cable with straight plug and straight socket | 2 m | 540332 | KVI-CP-3-GS-GD-2 |
| | | 5 m | 540333 | KVI-CP-3-GS-GD-5 |
| | | 8 m | 540334 | KVI-CP-3-GS-GD-8 |
|  | Connecting component for cabinet through feed | | 543252 | KVI-CP-3-SSD |
| Screws | | | | |
|  | For mounting on the metal interlinking block | | 550219 | CPX-M-M3X22-4X |
| Inscription labels | | | | |
|  | Inscription labels 6x10, in frames | 64 pieces | 18576 | IBS-6x10 |
| User documentation | | | | |
|  | Manual – End-position controller CPX-CMPX ¹⁾ | German | 555479 | P.BE-CPX-CMPX-SYS-DE |
| | | English | 555480 | P.BE-CPX-CMPX-SYS-EN |
| | | Spanish | 555481 | P.BE-CPX-CMPX-SYS-ES |
| | | French | 555482 | P.BE-CPX-CMPX-SYS-FR |
| | | Italian | 555483 | P.BE-CPX-CMPX-SYS-IT |

1) User documentation in paper form is not included in the scope of delivery.

Data sheet – Measuring module for displacement encoder

The measuring module CPX-CMIX is intended exclusively for use in valve terminals CPX.



General technical data

Operating voltage

| | | |
|--|--------|-----------|
| Operating voltage range | [V DC] | 18 ... 30 |
| Nominal operating voltage | [V DC] | 24 |
| Current consumption at nominal operating voltage | [mA] | 80 |
| Short circuit current rating | | Yes |
| Power failure buffering | [ms] | 10 |

| | | |
|------------------------------------|-----|-------------------|
| Number of axis strings | | 1 |
| Axes per string | | 1 |
| Length of connecting cable to axis | [m] | ≤ 30 |
| Max. number of modules | | 9 |
| Display | | 7-segment display |

| | | | |
|--------------------|---------|-------|-----|
| Assigned addresses | Outputs | [bit] | 6x8 |
| | Inputs | [bit] | 6x8 |

| | |
|-------------|----------------------------------|
| Diagnostics | Channel and module-oriented |
| | Via local 7-segment display |
| | Undervoltage of modules |
| | Undervoltage of measuring system |

| | |
|-------------------|------------|
| Status indication | Power load |
| | Error |

Control interface

| | |
|-----------------------|-----------------------------|
| Data | CAN bus with Festo protocol |
| | Digital |
| Electrical connection | 5-pin |
| | M9 |
| | Socket |

| | | | |
|--------------------|----------------|------|-----|
| Materials: Housing | PA-reinforced | | |
| Note on materials | RoHS-compliant | | |
| PWIS conformity | VDMA24364-B2-L | | |
| Product weight | [g] | 140 | |
| Dimensions | Length | [mm] | 107 |
| | Width | [mm] | 50 |
| | Height | [mm] | 55 |

Data sheet – Measuring module for displacement encoder

| Operating and environmental conditions | | |
|--|------|--------------------------|
| Ambient temperature | [°C] | -5 ... +50 |
| Storage temperature | [°C] | -20 ... +70 |
| Relative humidity | [%] | 5 ... 95, non-condensing |
| Degree of protection to IEC 60529 | | IP65 |

Connection and display components

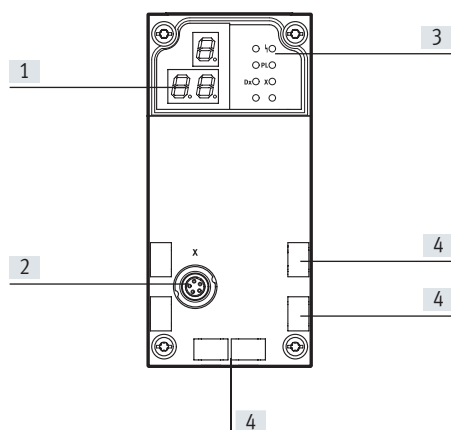

- [1] 3-digit display
- [2] Control interface
- [3] Status LEDs
- [4] Inscription labels

Pin allocation – Control interface

| | Pin | Signal | Designation |
|--|---------|-----------|---------------------------|
| | 1 | +24 V | Nominal operating voltage |
| | 2 | +24 V | Load voltage |
| | 3 | 0 V | Ground |
| | 4 | CAN_H | CAN high |
| | 5 | CAN_L | CAN low |
| | Housing | Shielding | Cable shielding |



Permitted bus nodes/CEC

| Bus node/CEC | Protocol | Max. number of CMIX modules |
|--------------|-------------------------|-----------------------------|
| CPX-CEC... | - | 9 |
| CPX-FB11 | DeviceNet ¹⁾ | 9 |
| CPX-FB13 | PROFIBUS ²⁾ | 9 |
| CPX-FB14 | CANopen | 5 |
| CPX-FB23-24 | CC-Link | 5 (as function module F23) |
| | | 9 (as function module F24) |
| CPX-FB36 | EtherNet/IP | 9 |
| CPX-FB37 | EtherCAT | 9 |
| CPX-FB39 | Sercos III | 9 |
| CPX-FB40 | POWERLINK | 9 |
| CPX-FB43 | PROFINET RT, M12 | 9 |
| CPX-M-FB44 | PROFINET RT, RJ45 | 9 |
| CPX-M-FB45 | PROFINET RT, SCRJ | 9 |

1) As of revision 20 (R20)

2) As of revision 23 (R23)

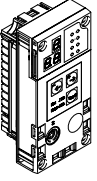
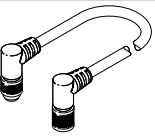
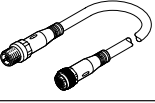
Data sheet – Measuring module for displacement encoder

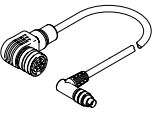
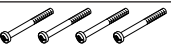
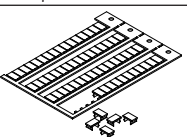
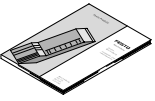
| Ordering data | | Brief description | Part no. | Type |
|--|--|-------------------|---------------|----------------------------|
| Measuring module | | | | |
|  | Order code in the CPX configurator: T23 | | 567417 | CPX-CMIX-M1-1 |
| Connecting cables | | | | |
|  | Connecting cable with angled plug and angled socket | 0.25 m | 540327 | KVI-CP-3-WS-WD-0.25 |
| | | 0.5 m | 540328 | KVI-CP-3-WS-WD-0.5 |
| | | 2 m | 540329 | KVI-CP-3-WS-WD-2 |
| | | 5 m | 540330 | KVI-CP-3-WS-WD-5 |
| | | 8 m | 540331 | KVI-CP-3-WS-WD-8 |
|  | Connecting cable with straight plug and straight socket | 2 m | 540332 | KVI-CP-3-GS-GD-2 |
| | | 5 m | 540333 | KVI-CP-3-GS-GD-5 |
| | | 8 m | 540334 | KVI-CP-3-GS-GD-8 |
|  | Connecting component for cabinet through feed | | 543252 | KVI-CP-3-SSD |
|  | For displacement encoder MME: Connection between displacement encoder MME and measuring module CPX-CMIX | 2 m | 575898 | NEBP-M16W6-K-2-M9W5 |
| Screws | | | | |
|  | For mounting on the metal interlinking block | | 550219 | CPX-M-M3X22-4X |
| Inscription labels | | | | |
|  | Inscription labels 6x10, in frames | 64 pieces | 18576 | IBS-6x10 |
| User documentation | | | | |
|  | Manual – Measuring module CPX-CMIX ¹⁾ | German | 567053 | P.BE-CPX-CMIX-DE |
| | | English | 567054 | P.BE-CPX-CMIX-EN |
| | | Spanish | 567055 | P.BE-CPX-CMIX-ES |
| | | French | 567056 | P.BE-CPX-CMIX-FR |
| | | Italian | 567057 | P.BE-CPX-CMIX-IT |

1) User documentation in paper form is not included in the scope of delivery.

Data sheet – Input module, digital

Function

Digital input modules enable the connection of two-wire and three-wire sensors (proximity switches, inductive or capacitive sensors, etc.).

Depending on the connection block selected, the module supports various connection concepts with different numbers of sockets (single or double allocation).

Area of application

- Input modules for 24 V DC sensor supply voltage
- PNP or NPN logic
- Supports connection blocks with M12, M8, Sub-D and terminal connection
- Module features can be parameterised
- The input module receives the supply voltage for the electronics and the sensors from the interlinking block
- Module protection and diagnostics through integrated electronic protection

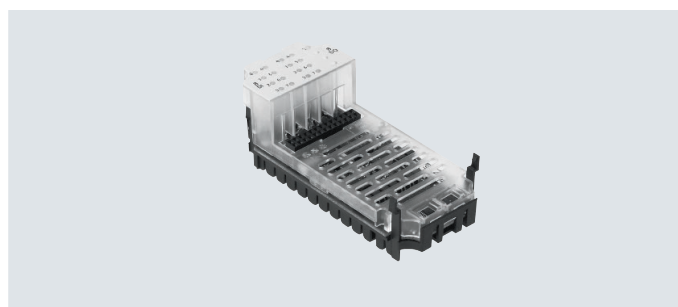

| General technical data | | | CPX-4DE | CPX-8DE | CPX-8DE-D | CPX-8NDE |
|--|------------------------|--------|--|-------------------------------------|--------------------------------------|-------------------------------------|
| Type | | | | | | |
| Number of inputs | | | 4 | 8 | 8 | 8 |
| Max. residual current of inputs per module | | [A] | 0.7 | 1 | 0.7 | 0.7 |
| Fuse protection | | | Internal electronic fuse per module | Internal electronic fuse per module | Internal electronic fuse per channel | Internal electronic fuse per module |
| Intrinsic current consumption at operating voltage | | [mA] | Typically 15 | | | |
| Operating voltage | Nominal value | [V DC] | 24 | | | |
| | Permissible range | [V DC] | 18 ... 30 | | | |
| Galvanic isolation | Channel – channel | | No | | | |
| | Channel – internal bus | | No | | | |
| Switching level | Signal 0 | [V DC] | ≤ 5 | | | ≥ 11 |
| | Signal 1 | [V DC] | ≥ 11 | | | ≤ 5 |
| Input debounce time | | [ms] | 3 (0.1, 10, 20 parameterisable) | | | |
| Input characteristic | | | IEC 1131-T2 | | | |
| Switching logic | | | Positive logic (PNP) | | | Negative logic (NPN) |
| LED displays | Group diagnostics | | 1 | 1 | 1 | 1 |
| | Channel diagnostics | | – | – | 8 | – |
| | Channel status | | 4 | 8 | 8 | 8 |
| Diagnostics | | | Short circuit/overload per channel | | | |
| Parameterisation | | | <ul style="list-style-type: none"> • Module monitoring • Behaviour after short circuit • Input debounce time • Signal extension time | | | |
| Degree of protection to EN 60529 | | | Depending on connection block | | | |
| Temperature range | Operation | [°C] | –5 ... +50 | | | |
| | Storage/transport | [°C] | –20 ... +70 | | | |
| Materials | | | Reinforced PA, PC | | | |
| PWIS conformity | | | VDMA24364-B2-L | | | |
| Grid dimension | | [mm] | 50 | | | |
| Dimensions (including interlinking block and connection block) W x L x H | | [mm] | 50 x 107 x 50 | | | |
| Product weight | | [g] | 39 | 39 | 45 | 40 |

Data sheet – Input module, digital

Connection and display components

CPX-4DE

CPX-8DE

CPX-8DE-D

CPX-8NDE

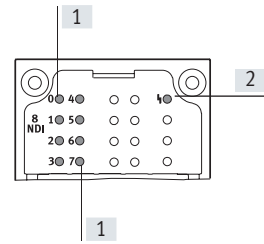
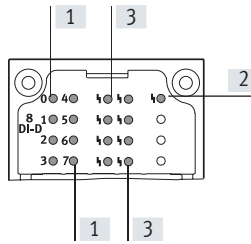
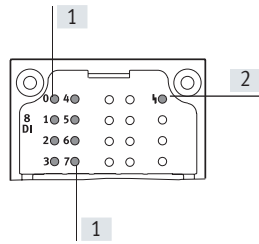
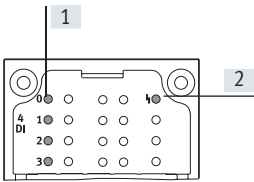

[1] Status LEDs (green)

[2] Error LED (red, module error)













[3] Channel-related error LEDs (red)

For allocation to inputs
→ Pin allocation for module

Combinations of connection blocks and digital input modules

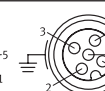
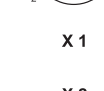
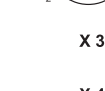
| Connection blocks | Part no. | Digital input modules | | | |
|-----------------------|----------|-----------------------|---------|-----------|----------|
| | | CPX-4DE | CPX-8DE | CPX-8DE-D | CPX-8NDE |
| CPX-AB-8-M8-3POL | 195706 | ■ | ■ | ■ | ■ |
| CPX-AB-4-M12X2-5POL | 195704 | ■ | ■ | ■ | ■ |
| CPX-AB-4-M12X2-5POL-R | 541254 | ■ | ■ | ■ | ■ |
| CPX-AB-8-KL-4POL | 195708 | ■ | ■ | ■ | ■ |
| CPX-AB-1-SUB-BU-25POL | 525676 | ■ | ■ | ■ | ■ |
| CPX-M-AB-4-M12X2-5POL | 549367 | ■ | ■ | ■ | ■ |

Pin allocation

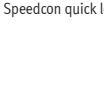
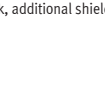

| Connection block inputs | CPX-4DE | CPX-8DE, CPX-8DE-D and CPX-8NDE | | |
|--|---------------------------|---------------------------------|-------------------------------|-------------------------------|
| CPX-AB-8-M8-3POL | | | | |
|  | X1.1: 24 V _{SEN} | X5.1: 24 V _{SEN} | X1.1: 24 V _{SEN x} | X5.1: 24 V _{SEN x+4} |
|  | X1.3: 0 V _{SEN} | X5.3: 0 V _{SEN} | X1.3: 0 V _{SEN x} | X5.3: 0 V _{SEN x+4} |
|  | X1.4: Input x | X5.4: Input x+2 | X1.4: Input x | X5.4: Input x+4 |
|  | X2.1: 24 V _{SEN} | X6.1: 24 V _{SEN} | X2.1: 24 V _{SEN x+1} | X6.1: 24 V _{SEN x+5} |
|  | X2.3: 0 V _{SEN} | X6.3: 0 V _{SEN} | X2.3: 0 V _{SEN x+1} | X6.3: 0 V _{SEN x+5} |
|  | X2.4: Input x+1 | X6.4: Input x+3 | X2.4: Input x+1 | X6.4: Input x+5 |
|  | X3.1: 24 V _{SEN} | X7.1: 24 V _{SEN} | X3.1: 24 V _{SEN x+2} | X7.1: 24 V _{SEN x+6} |
|  | X3.3: 0 V _{SEN} | X7.3: 0 V _{SEN} | X3.3: 0 V _{SEN x+2} | X7.3: 0 V _{SEN x+6} |
| | X3.4: Input x+1 | X7.4: Input x+3 | X3.4: Input x+2 | X7.4: Input x+6 |
| | X4.1: 24 V _{SEN} | X8.1: 24 V _{SEN} | X4.1: 24 V _{SEN x+3} | X8.1: 24 V _{SEN x+7} |
| | X4.3: 0 V _{SEN} | X8.3: 0 V _{SEN} | X4.3: 0 V _{SEN x+3} | X8.3: 0 V _{SEN x+7} |
| | X4.4: n.c. | X8.4: n.c. | X4.4: Input x+3 | X8.4: Input x+7 |
| CPX-AB-4-M12X2-5POL, CPX-AB-4-M12X2-5POL-R¹⁾ and CPX-M-AB-4-M12X2-5POL | | | | |
|  | X1.1: 24 V _{SEN} | X3.1: 24 V _{SEN} | X1.1: 24 V _{SEN x} | X3.1: 24 V _{SEN x+4} |
|  | X1.2: Input x+1 | X3.2: Input x+3 | X1.2: Input x+1 | X3.2: Input x+5 |
|  | X1.3: 0 V _{SEN} | X3.3: 0 V _{SEN} | X1.3: 0 V _{SEN x} | X3.3: 0 V _{SEN x+4} |
|  | X1.4: Input x | X3.4: Input x+2 | X1.4: Input x | X3.4: Input x+4 |
|  | X1.5: FE | X3.5: FE | X1.5: FE | X3.5: FE |
|  | X2.1: 24 V _{SEN} | X4.1: 24 V _{SEN} | X2.1: 24 V _{SEN x+2} | X4.1: 24 V _{SEN x+6} |
|  | X2.2: n.c. | X4.2: n.c. | X2.2: Input x+3 | X4.2: Input x+7 |
|  | X2.3: 0 V _{SEN} | X4.3: 0 V _{SEN} | X2.3: 0 V _{SEN x+2} | X4.3: 0 V _{SEN x+6} |
|  | X2.4: Input x+1 | X4.4: Input x+3 | X2.4: Input x+2 | X4.4: Input x+6 |
|  | X2.5: FE | X4.5: FE | X2.5: FE | X4.5: FE |

1) Speedcon quick lock, additional shielding on metal thread

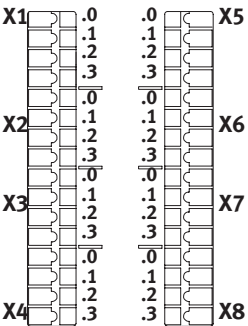
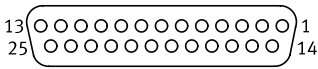

Data sheet – Input module, digital

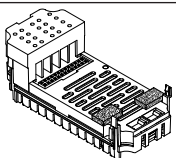
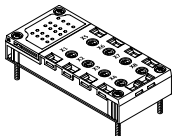
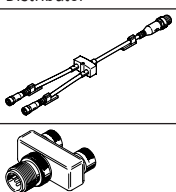
| Pin allocation | | CPX-4DE | | CPX-8DE, CPX-8DE-D and CPX-8NDE | |
|--|---------------------------|---------------------------|-------------------------------|---------------------------------|--|
| CPX-AB-8-KL-4POL | | | | | |
|  | X1.0: 24 V _{SEN} | X5.0: 24 V _{SEN} | X1.0: 24 V _{SEN x} | X5.0: 24 V _{SEN x+4} | |
| | X1.1: 0 V _{SEN} | X5.1: 0 V _{SEN} | X1.1: 0 V _{SEN x} | X5.1: 0 V _{SEN x+4} | |
| | X1.2: Input x | X5.2: Input x+2 | X1.2: Input x | X5.2: Input x+4 | |
| | X1.3: FE | X5.3: FE | X1.3: FE | X5.3: FE | |
| | X2.0: 24 V _{SEN} | X6.0: 24 V _{SEN} | X2.0: 24 V _{SEN x+1} | X6.0: 24 V _{SEN x+5} | |
| | X2.1: 0 V _{SEN} | X6.1: 0 V _{SEN} | X2.1: 0 V _{SEN x+1} | X6.1: 0 V _{SEN x+5} | |
| | X2.2: Input x+1 | X6.2: Input x+3 | X2.2: Input x+1 | X6.2: Input x+5 | |
| | X2.3: FE | X6.3: FE | X2.3: FE | X6.3: FE | |
| | X3.0: 24 V _{SEN} | X7.0: 24 V _{SEN} | X3.0: 24 V _{SEN x+2} | X7.0: 24 V _{SEN x+6} | |
| | X3.1: 0 V _{SEN} | X7.1: 0 V _{SEN} | X3.1: 0 V _{SEN x+2} | X7.1: 0 V _{SEN x+6} | |
| | X3.2: Input x+1 | X7.2: Input x+3 | X3.2: Input x+2 | X7.2: Input x+6 | |
| | X3.3: FE | X7.3: FE | X3.3: FE | X7.3: FE | |
| | X4.0: 24 V _{SEN} | X8.0: 24 V _{SEN} | X4.0: 24 V _{SEN x+3} | X8.0: 24 V _{SEN x+7} | |
| | X4.1: 0 V _{SEN} | X8.1: 0 V _{SEN} | X4.1: 0 V _{SEN x+3} | X8.1: 0 V _{SEN x+7} | |
| X4.2: n.c. | X8.2: n.c. | X4.2: Input x+3 | X8.2: Input x+7 | | |
| X4.3: FE | X8.3: FE | X4.3: FE | X8.3: FE | | |
| CPX-AB-1-SUB-BU-25POL | | | | | |
|  | 1: Input x | 14: Input x+2 | 1: Input x | 14: Input x+4 | |
| | 2: Input x+1 | 15: Input x+3 | 2: Input x+1 | 15: Input x+5 | |
| | 3: Input x+1 | 16: Input x+3 | 3: Input x+2 | 16: Input x+6 | |
| | 4: n.c. | 17: n.c. | 4: Input x+3 | 17: Input x+7 | |
| | 5: 24 V _{SEN} | 18: 24 V _{SEN} | 5: 24 V _{SEN x+1} | 18: 24 V _{SEN x+4} | |
| | 6: 0 V _{SEN} | 19: 24 V _{SEN} | 6: 0 V _{SEN x+1} | 19: 24 V _{SEN x+5} | |
| | 7: 24 V _{SEN} | 20: 24 V _{SEN} | 7: 24 V _{SEN x+3} | 20: 24 V _{SEN x+6} | |
| | 8: 0 V _{SEN} | 21: 24 V _{SEN} | 8: 0 V _{SEN x+3} | 21: 24 V _{SEN x+7} | |
| | 9: 24 V _{SEN} | 22: 0 V _{SEN} | 9: 24 V _{SEN x} | 22: 0 V _{SEN x+2 u. 3} | |
| | 10: 24 V _{SEN} | 23: 0 V _{SEN} | 10: 24 V _{SEN x+2} | 23: 0 V _{SEN x+2 u. 3} | |
| | 11: 0 V _{SEN} | 24: 0 V _{SEN} | 11: 0 V _{SEN x} | 24: 0 V _{SEN x+2 u. 3} | |
| | 12: 0 V _{SEN} | 25: FE | 12: 0 V _{SEN x+2} | 25: FE | |
| | 13: FE | Housing: FE | 13: FE | Housing: FE | |

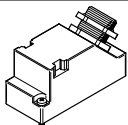
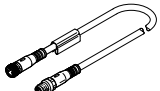
Data sheet – Input module, digital

| Ordering data | | | | Part no. | Type |
|--|--|--|---------------------|----------------------------|------------------------------|
| Designation | | | | | |
| Input module, digital | | | | | |
|  | 4 digital inputs, positive logic (PNP) | | | 195752 | CPX-4DE |
| | 8 digital inputs, positive logic (PNP) | | | 195750 | CPX-8DE |
| | 8 digital inputs, positive logic (PNP), enhanced diagnostic function | | | 541480 | CPX-8DE-D |
| | 8 digital inputs, negative logic (NPN) | | | 543813 | CPX-8NDE |
| Connection block | | | | | |
|  | Plastic | 8x socket M8, 3-pin | | 195706 | CPX-AB-8-M8-3POL |
| | | 4x socket M12, 5-pin | | 195704 | CPX-AB-4-M12X2-5POL |
| | | 4x socket, M12 with quick-lock technology, 5-pin | | 541254 | CPX-AB-4-M12X2-5POL-R |
| | | Spring-loaded terminal, 32-pin | | 195708 | CPX-AB-8-KL-4POL |
| | Metal | 4x socket M12, 5-pin | | 549367 | CPX-M-AB-4-M12X2-5POL |
| Distributor | | | | | |
|  | Modular system for all types of sensor/actuator distributor | | | – | NEDY-... → Internet: nedy |
| |  | 1x plug M12, 4-pin | 2x socket M8, 3-pin | 8005311 | NEDY-L2R1-V1-M8G3-N-M12G4 |
| 2x socket M12, 5-pin | | | 8005310 | NEDY-L2R1-V1-M12G5-N-M12G4 | |
| Plug | | | | | |
|  | Plug | M8, 3-pin | Solderable | 18696 | SEA-GS-M8 |
| | | | Screw-in | 192009 | SEA-3GS-M8-S |
| | | M12, 4-pin, PG7 | | 18666 | SEA-GS-7 |
| | | M12, PG7, 4-pin for cable Ø 2.5 mm | | 192008 | SEA-4GS-7-2.5 |
| | | M12, 4-pin, PG9 | | 18778 | SEA-GS-9 |
| | | M12, 4 pin for 2 cables | | 18779 | SEA-GS-11-DUO |
| | | M12 for 2 cables, 5-pin | | 192010 | SEA-5GS-11-DUO |
|  | Sub-D plug, 25-pin | M12, 5-pin | | 175487 | SEA-M12-5GS-PG7 |
| | | | | 527522 | SD-SUB-D-ST25 |
| Connecting cable | | | | | |
|  | Connecting cable M8-M8 | 0.5 m | | 541346 | NEBU-M8G3-K-0.5-M8G3 |
| | | 1.0 m | | 541347 | NEBU-M8G3-K-1-M8G3 |
| | | 2.5 m | | 541348 | NEBU-M8G3-K-2.5-M8G3 |
| | | 5.0 m | | 541349 | NEBU-M8G3-K-5-M8G3 |
| | Modular system for a choice of connecting cables | | | – | NEBU-... → Internet: nebu |

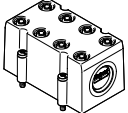
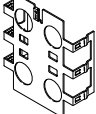
Data sheet – Input module, digital

| Ordering data | | Part no. | Type | |
|---|--|----------|----------------|----------------|
| Designation | | | | |
| Cover | | | | |
|  | Cover for CPX-AB-8-KL-4POL (IP65, IP67) • 8 cable through feeds M9 • 1 cable through feed for multi-pin plug | 538219 | AK-8KL | |
| | Fittings kit | 538220 | VG-K-M9 | |
| Screening plate | | | | |
|  | Screening plate for M12 connections | 526184 | CPX-AB-S-4-M12 | |
| User documentation | | | | |
|  | User documentation | German | 526439 | P.BE-CPX-EA-DE |
| | | English | 526440 | P.BE-CPX-EA-EN |
| | | Spanish | 526441 | P.BE-CPX-EA-ES |
| | | French | 526442 | P.BE-CPX-EA-FR |
| | | Italian | 526443 | P.BE-CPX-EA-IT |

Data sheet – Input module, digital, NAMUR

Function

Digital input modules enable the connection of up to 8 NAMUR sensors (or wired mechanical contacts). In addition, the first 4 channels can alternatively be used as counters or for frequency measurement.

M12 and terminal strip connection technology can be used.

Area of application

- Input modules for 24 V DC sensor supply voltage
- Module features can be parameterised
- The input module receives the supply voltage for the electronics and the sensors from the interlinking block
- Module protection and diagnostics through integrated electronic protection in each channel

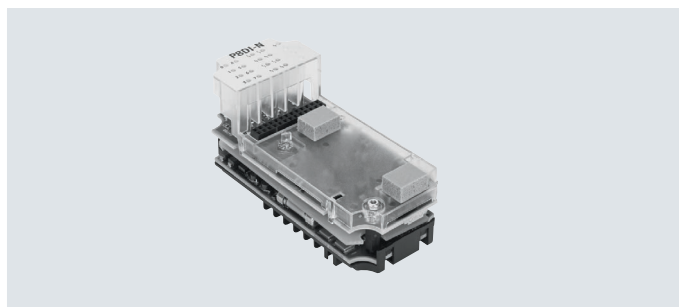

| General technical data | | CPX-P-8DE-N |
|---|--|--------------------------------------|
| Type | | CPX-P-8DE-N |
| Number of inputs | | 8 |
| Maximum cable length | [m] | 200 |
| Input debounce time | [ms] | 3 (0, 10, 20 parameterisable) |
| Fuse protection (short circuit) | | Internal electronic fuse per channel |
| Module current consumption (power supply for electronics) | [mA] | Typically 75 |
| Nominal operating voltage | [V DC] | 24 (reverse polarity protected) |
| Permissible voltage fluctuations | [%] | ±25 |
| Power failure buffering | [ms] | 20 |
| Residual ripple | [Vss] | 0.4 |
| Galvanic isolation | Channel – channel | No |
| | Channel – internal bus | Yes |
| Input characteristics | | To EN 60947-5-6 |
| Switching level | | To EN 60947-5-6 |
| LED displays | Group diagnostics | 1 |
| | Channel diagnostics | 8 |
| | Channel status | 8 |
| Diagnostics | Wire break per channel | |
| | Limit value violation per channel | |
| | Parameterisation error | |
| | Overload per channel | |
| Parameterisation | Data format | |
| | Input debounce time per channel | |
| | Input function per channel | |
| | Replacement value in diagnostic case per channel | |
| | Upper limit value per channel | |
| | Signal extension time per channel | |
| | Gate time per channel | |
| | Monitoring of limit values per channel | |
| | Monitoring of short circuit per channel | |
| | Monitoring of wire break per channel | |
| | Monitoring of parameters | |
| | Lower limit value per channel | |
| | Upper limit value per channel | |
| | Counter configuration per channel | |
| Control elements | | DIL switch |
| Additional functions | Frequency measurement | |
| | Counter function | |
| Degree of protection to EN 60529 | | Depending on the connection block |

Data sheet – Input module, digital, NAMUR

| General technical data | | |
|--|------|---------------|
| Grid dimension | [mm] | 50 |
| Dimensions (including interlinking block and connection block) W x L x H | [mm] | 50 x 107 x 70 |
| Product weight | [g] | 100 |

| Materials | |
|-------------------|---------------------|
| Housing | PA-reinforced PC |
| Note on materials | RoHS-compliant |
| PWIS conformity | VDMA24364 zone III |

| Operating and environmental conditions | | |
|--|------|--------------------|
| Ambient temperature | [°C] | -5 ... +50 |
| Storage temperature | [°C] | -20 ... +70 |
| Relative humidity | [%] | 95, non-condensing |

Connection and display components

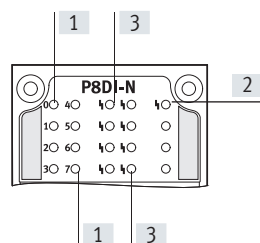

- [1] Status LEDs (green): for allocation to the inputs → pin allocation of the module
- [2] Error LED (red, module error)
- [3] Channel-related error LEDs (red)

Combinations of bus nodes/control blocks with digital input module

| Bus node/control block | Part no. | Digital input module |
|------------------------|----------|----------------------|
| | | CPX-P-8DE-N |
| CPX-CEC-C1-V3 | 3473128 | ■ |
| CPX-CEC-M1-V3 | 3472765 | ■ |
| CPX-CEC-S1-V3 | 3472425 | ■ |
| CPX-FB11 | 526172 | ■ |
| CPX-FB13 | 195740 | ■ |
| CPX-FB14 | 526174 | ■ |
| CPX-FB36 | 1912451 | ■ |
| CPX-FB37 | 2735960 | ■ |
| CPX-FB43 | 8110369 | ■ |
| CPX-M-FB44 | 8110370 | ■ |
| CPX-M-FB45 | 8110371 | ■ |





Combinations of connection block and digital input module

| Connection blocks | Part no. | Digital input module |
|---------------------|----------|----------------------|
| | | CPX-P-8DE-N |
| CPX-P-AB-4XM12-4POL | 565706 | ■ |
| CPX-P-AB-2XKL-8POL | 565704 | ■ |

Data sheet – Input module, digital, NAMUR

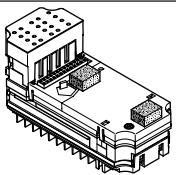
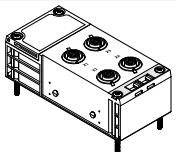
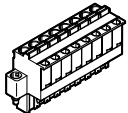
| Pin allocation | | CPX-P-8DE-N | |
|--|----------|--|--|
| Connection block inputs | | CPX-P-8DE-N | |
| CPX-P-AB-4XM12-4POL | | | |
| | | X1.1: BN+ [0] X1.2: BU- [0] X1.3: BN+ [1] X1.4: BU- [1] X2.1: BN+ [2] X2.2: BU- [2] X2.3: BN+ [3] X2.4: BU- [3] | X3.1: BN+ [4] X3.2: BU- [4] X3.3: BN+ [5] X3.4: BU- [5] X4.1: BN+ [6] X4.2: BU- [6] X4.3: BN+ [7] X4.4: BU- [7] |
| CPX-P-AB-2XKL-8POL | | | |
| | | X1.1: BN+ [0] X1.2: BU- [0] X1.3: BN+ [1] X1.4: BU- [1] X1.5: BN+ [2] X1.6: BU- [2] X1.7: BN+ [3] X1.8: BU- [3] | X2.1: BN+ [4] X2.2: BU- [4] X2.3: BN+ [5] X2.4: BU- [5] X2.5: BN+ [6] X2.6: BU- [6] X2.7: BN+ [7] X2.8: BU- [7] |
| Combinations of interlinking block/digital input module | | | |
| Interlinking blocks | Part no. | Digital input module CPX-P-8DE-N | |
| CPX-GE-EV-S | 195746 | - | |
| CPX-GE-EV-S-VL | 8022170 | - | |
| CPX-GE-EV-S-7/8-4POL | 541248 | - | |
| CPX-M-GE-EV-S-7/8-CIP-4P | 568956 | - | |
| CPX-GE-EV-S-7/8-5POL | 541244 | - | |
| CPX-GE-EV-S-7/8-5POL-VL | 8022172 | - | |
| CPX-M-GE-EV-S-7/8-5POL | 550208 | ■ | |
| CPX-M-GE-EV-S-7/8-5POL-VL | 8022165 | ■ | |
| CPX-M-GE-EV-S-M12-5POL | 8098392 | - | |
| CPX-M-GE-EV-S-PP-5POL | 563057 | - | |
| CPX-GE-EV | 195742 | - | |
| CPX-M-GE-EV | 550206 | ■ | |
| CPX-GE-EV-Z | 195744 | - | |
| CPX-GE-EV-Z-VL | 8022166 | - | |
| CPX-GE-EV-Z-7/8-4POL | 541250 | - | |
| CPX-GE-EV-Z-7/8-5POL | 541246 | - | |
| CPX-GE-EV-Z-7/8-5POL-VL | 8022173 | - | |
| CPX-M-GE-EV-Z-7/8-5POL | 550210 | ■ | |
| CPX-M-GE-EV-Z-7/8-5POL-VL | 8022158 | ■ | |
| CPX-M-GE-EV-Z-PP-5POL | 563058 | - | |
| CPX-GE-EV-V | 533577 | - | |
| CPX-GE-EV-V-VL | 8022171 | - | |
| CPX-GE-EV-V-7/8-4POL | 541252 | - | |
| CPX-M-GE-EV-W-M12-5POL | 8098391 | - | |

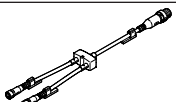
Data sheet – Input module, digital, NAMUR

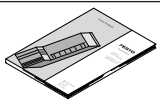
| Ordering data | | | | | |
|---|--|--|--|----------|------------------------------|
| Designation | | | | Part no. | Type |
| Input module, digital, NAMUR | | | | | |
|  | 8 digital inputs | | | 565933 | CPX-P-8DE-N |
| Connection block | | | | | |
|  | Plastic | 4x socket, M12, 4-pin | | 565706 | CPX-P-AB-4XM12-4POL |
| | | 2x plug, 8-pin | | 565704 | CPX-P-AB-2XKL-8POL |
| Plug | | | | | |
|  | Socket | 8-pin | Spring-loaded terminal | 565712 | NECU-L3G8-C1 |
| | | | Screw terminal | 565710 | NECU-L3G8-C2 |
|  | Plug M12x1, 4-pin, straight, A-coded | Screw terminal | Connection cross section 0.14 ... 0.5 mm ² | 192008 | SEA-4GS-7-2.5 |
| | | | Nominal conductor cross section 0.14 ... 0.75 mm ² | 18666 | SEA-GS-7 |
| | | | Permissible cable \varnothing 4 ... 6 mm | | |
| | | | Connection cross section 0.75 mm ² | 18778 | SEA-GS-9 |
| | | Permissible cable \varnothing 6 ... 8 mm | | | |
| Distributor | | | | | |
|  | Modular system for all types of sensor/actuator distributor | | | – | NEDY-... → Internet: nedy |
| Cover | | | | | |
|  | Cover cap for closing off unused connections (10 pieces) | | For M12 connections | 165592 | ISK-M12 |
| Coding element | | | | | |
|  | To ensure that a coded socket NECU-L3G8 can only be inserted in the matching coded connection block CPX-P-AB-2XKL (96 of each) | | For NECU-L3G8 | 565713 | CPX-P-KDS-AB-2XKL |
| User documentation | | | | | |
|  | User documentation | | German | 575378 | P.BE-CPX-P-EA-DE |
| | | | English | 575379 | P.BE-CPX-P-EA-EN |
| | | | Spanish | 575380 | P.BE-CPX-P-EA-ES |
| | | | French | 575381 | P.BE-CPX-P-EA-FR |
| | | | Italian | 575382 | P.BE-CPX-P-EA-IT |
| | | | Swedish | 575383 | P.BE-CPX-P-EA-SV |

Data sheet – Input module, digital, PROFI-safe

Function

The PROFI-safe input module has 8 input channels whose signal status is detected for safety reasons, with the information transmitted to a suitable safety controller using the PROFI-safe safety protocol in combination with the appropriate fieldbus (PROFINET or PROFIBUS). This function is exclusively available for safety controllers using the PROFI-safe protocol, profile version 2.4.

Area of application

- Input module for 24 V DC sensor supply voltage
- Supports connection blocks with M12 and terminal connection
- Module features can be parameterised
- The input module receives the supply voltage for the electronics and the sensors from the interlinking block
- Module protection and diagnostics through integrated electronic protection

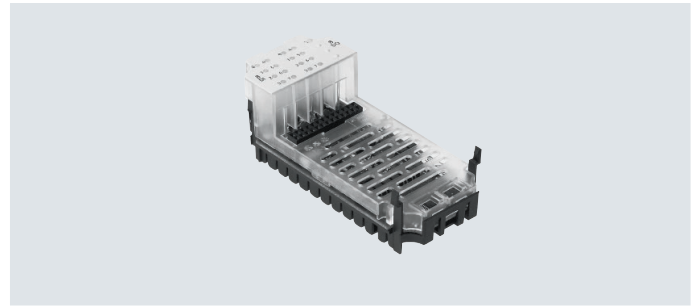
**Description****Module-based passivation**

While channel-based passivation is disabled, the input module, in accordance with PROFI-safe specification, switches all information in the input image to the safe status, even when there is only one channel error.

Channel-based passivation

In the case of channel-based passivation, when a channel error occurs, the input module switches the input information of the affected channel pair to 0, depending on the function mode.

- The input information for unaffected channel pairs does not change
- The input module remains integrated.
- The input module indicates the current channel error status to the control unit via the input image.

Applications

The inputs on the PROFI-safe input module can be combined for multi-channel sensor applications. Every two inputs form a channel pair, which is set separately with one of 11 function modes.

The function mode has an influence on the evaluation of the input signals, and optionally on the generation of clock signals.

There are 5 independent clock outputs available for safe operation of passive sensors; the pulse patterns are used in some operating modes to detect crossovers in the signal paths.

The entire input module is designed to ensure that the input channels provide either secure data or no data at all, even when an error is present in the system

Range of applications

- Use as an input module for a higher-order safety controller. Several input modules can be used together and these monitor mutually independent sensors
- Use of multi-channel sensor applications with up to 8 secure inputs, which can be grouped and are suitable for configuration with the help of 11 different function modes
- Connection of various switches and sensors within the safety chain
- Output of an identifier coded by DIL switch in the connection block CPX-AB-ID-P

**Note**

The safety integrity level, Performance Level and category for the system as a whole correspond to that of the component in the safety chain with the lowest characteristic value.

Application examples

- Two-hand control device for starting a function
- Operating mode selector switch with four positions
- Light curtain
- End-position switch
- Emergency stop switch for incidents
- Rotary indexing table
- Acknowledge button with request
- Protective door with two NO switches

Data sheet – Input module, digital, PROFIsafe

| General technical data | | | |
|--|--------------------------|--------|--|
| Type | | | CPX-F8DE-P |
| Number of inputs | | | 8 |
| Safety function | | | Reliable detection and evaluation of input statuses |
| Max. address capacity | Inputs | [byte] | 6 |
| | Outputs | [byte] | 7 |
| Maximum cable length | | [m] | 200 |
| Max. power supply | Per module | [A] | 3 |
| Current consumption of module | | [mA] | Typically 35 (power supply for electronics) |
| Operating voltage | Nominal value | [V DC] | 24 |
| | Permissible range | [V DC] | 20.4 ... 28.8 |
| Voltage drop per channel | | [V] | 0.6 |
| Residual ripple | | [Vss] | 2 within voltage range |
| Galvanic isolation | Channel – channel | | No |
| Input characteristics | | | To IEC 61131-2, type 2 |
| Switching logic | Inputs | | PNP (positive switching) |
| Safety integrity level | As per EN 62061 | | Reliable detection and evaluation of input statuses up to SIL CL3 |
| | As per EN 61508 | | Reliable detection and evaluation of input statuses up to SIL3 |
| Performance Level | As per ISO 13849 | | Reliable detection and evaluation of input statuses up to Cat 4 and PL e |
| Failure rate per hour (PFH) | | | 1.0×10^{-9} |
| Certificate issuing authority | | | 01/205/5444.01/21 |
| LED displays | Group diagnostics | | 1 |
| | Channel diagnostics | | 8 |
| | Channel status | | 8 |
| | Failsafe protocol active | | 1 |
| Diagnostics | | | <ul style="list-style-type: none"> • Short circuit per channel • Undervoltage • Overvoltage • Excessive temperature • Crossover per channel • Wire break per channel • Communication • Process data error • Self-test |
| Control elements | | | DIL switch |
| Degree of protection to EN 60529 | | | Depending on connection block |
| Grid dimension | | [mm] | 50 |
| Dimensions (including interlinking block and connection block) W x L x H | | [mm] | 50 x 107 x 55 |
| Product weight | | [g] | 46 |

Data sheet – Input module, digital, PROFIsafe

| Materials | | |
|--|------|---------------------------------|
| Note on materials | | RoHS-compliant |
| PWIS conformity | | VDMA24364-B2-L |
| Operating and environmental conditions | | |
| Ambient temperature | [°C] | -5 ... +50 |
| Storage temperature | [°C] | -20 ... +70 |
| CE marking (see declaration of conformity) ¹⁾ | | To EU Machinery Directive |
| | | To EU EMC Directive |
| | | To EU RoHS Directive |
| UKCA marking (see declaration of conformity) ¹⁾ | | To UK instructions for machines |
| | | To UK instructions for EMC |
| | | To UK RoHS instructions |
| Certification | | c UL us - Recognized (OL) |

1) Additional information at: www.festo.com/catalogue/... → Support/Downloads.

Connection and display components

CPX-F8DE-P

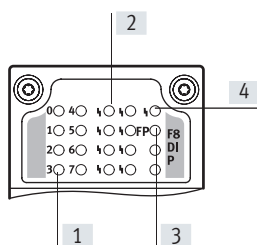

- [1] Channel-related status LEDs (green)
- [2] Channel-related error LEDs (red)
- [3] Fail-safe protocol active (green)
- [4] Error LED (red, module error)

Combinations of bus nodes/control blocks with PROFIsafe input module

| Bus node/control block | Part no. | PROFIsafe input module |
|------------------------|----------|------------------------|
| | | CPX-F8DE-P |
| CPX-FB13 | 195740 | ■ |
| CPX-FB43 | 8110369 | ■ |
| CPX-M-FB44 | 8110370 | ■ |
| CPX-M-FB45 | 8110371 | ■ |

Note
 The PROFIsafe input module CPX-F8DE-P can only be integrated as of software release 21 or release 30 (in the case of CPX-FB13).

Data sheet – Input module, digital, PROFIsafe

| Combinations of connection blocks and PROFIsafe input module | | |
|--|----------|------------------------|
| Connection blocks | Part no. | PROFIsafe input module |
| | | CPX-F8DE-P |
| CPX-M-AB-4-M12X2-5POL | 549367 | ■ |
| CPX-M-AB-4-M12X2-5POL-T | 2639560 | ■ |
| CPX-AB-8-KL-4POL | 195708 | ■ |
| CPX-AB-ID-P | 2639571 | ■ |

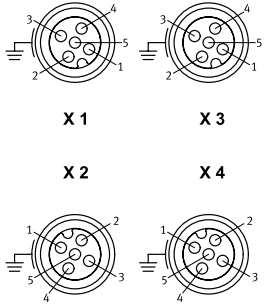
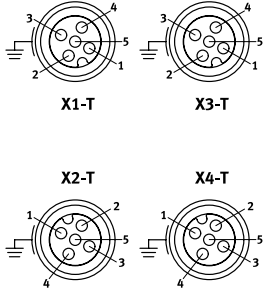
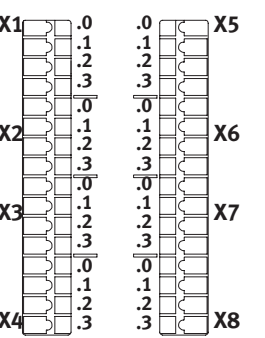
| Pin allocation | |
|--|---|
| Connection block inputs | CPX-F8DE-P |
| CPX-M-AB-4-M12X2-5POL | |
|  <p>X 1 X 3 X 2 X 4</p> | <p>X1.1: 24 V_{SEN} X1.2: Input x+1 X1.3: 0 V_{SEN} X1.4: Input x X1.5: FE X2.1: 24 V_{SEN} X2.2: Input x+3 X2.3: 0 V_{SEN} X2.4: Input x+2 X2.5: FE</p> <p>X3.1: 24 V_{SEN} X3.2: Input x+5 X3.3: 0 V_{SEN} X3.4: Input x+4 X3.5: FE X4.1: 24 V_{SEN} X4.2: Input x+7 X4.3: 0 V_{SEN} X4.4: Input x+6 X4.5: FE</p> |
| CPX-M-AB-4-M12X2-5POL-T | |
|  <p>X1-T X3-T X2-T X4-T</p> | <p>X1-T.1: 24 V_{SEN x} X1-T.2: Input x+1 X1-T.3: 0 V_{SEN} X1-T.4: Input x X1-T.5: 24 V_{SEN x+1} X2-T.1: 24 V_{SEN x+2} X2-T.2: Input x+3 X2-T.3: 0 V_{SEN} X2-T.4: Input x+2 X2-T.5: 24 V_{SEN x+3}</p> <p>X3-T.1: 24 V_{SEN x+4} X3-T.2: Input x+5 X3-T.3: 0 V_{SEN} X3-T.4: Input x+4 X3-T.5: 24 V_{SEN x+5} X4-T.1: 24 V_{SEN x+6} X4-T.2: Input x+7 X4-T.3: 0 V_{SEN} X4-T.4: Input x+6 X4-T.5: 24 V_{SEN x+7}</p> |
| CPX-AB-8-KL-4POL | |
|  <p>X1 X5 X2 X6 X3 X7 X4 X8</p> | <p>X1.0: 24 V_{SEN} X1.1: 0 V_{SEN} X1.2: Input x X1.3: FE X2.0: 24 V_{SEN x} X2.1: 24 V_{SEN x+1} X2.2: Input x+1 X2.3: FE X3.0: 24 V_{SEN} X3.1: 0 V_{SEN} X3.2: Input x+2 X3.3: FE X4.0: 24 V_{SEN x+2} X4.1: 24 V_{SEN x+3} X4.2: Input x+3 X4.3: FE</p> <p>X5.0: 24 V_{SEN} X5.1: 0 V_{SEN} X5.2: Input x+4 X5.3: FE X6.0: 24 V_{SEN x+4} X6.1: 24 V_{SEN x+5} X6.2: Input x+5 X6.3: FE X7.0: 24 V_{SEN} X7.1: 0 V_{SEN} X7.2: Input x+6 X7.3: FE X8.0: 24 V_{SEN x+6} X8.1: 24 V_{SEN x+7} X8.2: Input x+7 X8.3: FE</p> |



Data sheet – Input module, digital, PROFIsafe

| General technical data | |
|--|---|
| Type | CPX-AB-ID-P |
| Certificate issuing authority | 01/205/5444.00/15 German Technical Control Board (TÜV) Rh. UK 01/205U/5444.00/22 |
| Degree of protection to EN 60529 | IP65 |
| Housing material | PA PC |
| Note on materials | RoHS-compliant |
| PWIS conformity | VDMA24364-B2-L |
| Corrosion resistance class CRC ¹⁾ | 1 |
| Product weight [g] | 57 |

1) Additional information: www.festo.com/x/topic/kbk

| Combinations of interlinking blocks and PROFIsafe input module | | |
|--|----------------|------------------------|
| Interlinking blocks | Part no. | PROFIsafe input module |
| | | CPX-F8DE-P |
| CPX-GE-EV-S | 195746 | – |
| CPX-GE-EV-S-VL | 8022170 | – |
| CPX-GE-EV-S-7/8-4POL | 541248 | – |
| CPX-GE-EV-S-7/8-5POL | 541244 | – |
| CPX-GE-EV-S-7/8-5POL-VL | 8022172 | – |
| CPX-M-GE-EV-S-7/8-CIP-4P | 568956 | ■ |
| CPX-M-GE-EV-S-7/8-5POL | 550208 | ■ |
| CPX-M-GE-EV-S-7/8-5POL-VL | 8022165 | ■ |
| CPX-M-GE-EV-S-M12-5POL | 8098392 | ■ |
| CPX-M-GE-EV-S-PP-5POL | 563057 | ■ |
| CPX-GE-EV | 195742 | – |
| CPX-M-GE-EV | 550206 | ■ |
| CPX-M-GE-EV-FVO | 567806 | – |
| CPX-GE-EV-Z | 195744 | – |
| CPX-GE-EV-Z-VL | 8022166 | – |
| CPX-GE-EV-Z-7/8-4POL | 541250 | – |
| CPX-GE-EV-Z-7/8-5POL | 541246 | – |
| CPX-GE-EV-Z-7/8-5POL-VL | 8022173 | – |
| CPX-M-GE-EV-Z-7/8-5POL | 550210 | ■ |
| CPX-M-GE-EV-Z-7/8-5POL-VL | 8022158 | ■ |
| CPX-M-GE-EV-Z-PP-5POL | 563058 | ■ |
| CPX-GE-EV-V | 533577 | – |
| CPX-GE-EV-V-VL | 8022171 | – |
| CPX-GE-EV-V-7/8-4POL | 541252 | – |
| CPX-M-GE-EV-W-M12-5POL | 8098391 | ■ |

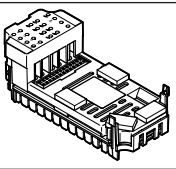
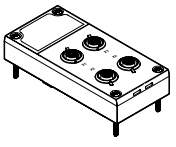
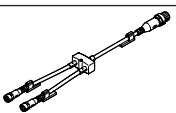
Data sheet – Input module, digital, PROFI-safe

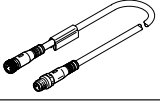
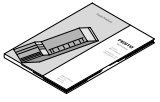
| Ordering data | | Description | Part no. | Type | |
|---|---|--|------------------------|-------------------------------------|--------------------------------|
| PROFI-safe input module | | | | | |
|  | 8 digital inputs, positive logic (PNP), for reliable detection and evaluation of input statuses | | 2597424 | CPX-F8DE-P | |
| Connection block | | | | | |
|  | Plastic | Spring-loaded terminal, 32-pin | 195708 | CPX-AB-8-KL-4POL | |
| | | 8-way DIL switch | 2639571 | CPX-AB-ID-P | |
| | Metal | 4x socket M12, 5-pin | Unpulsed sensor supply | 549367 | CPX-M-AB-4-M12X2-5POL |
| | | | Pulsed sensor supply | 2639560 | CPX-M-AB-4-M12X2-5POL-T |
| Distributor | | | | | |
|  | Modular system for all types of sensor/actuator distributor | | – | NEDY-... → Internet: nedy | |
|  | 1x plug M12, 4-pin | 2x socket M12, 5-pin | 8005310 | NEDY-L2R1-V1-M12G5-N-M12G4 | |
| Plug | | | | | |
|  | Plug | M12, PG7 | 18666 | SEA-GS-7 | |
| | | M12, PG7, 4-pin for cable \varnothing 2.5 mm | 192008 | SEA-4GS-7-2.5 | |
| | | M12, PG9 | 18778 | SEA-GS-9 | |
| | | M12 for 2 cables | 18779 | SEA-GS-11-DUO | |
| | | M12 for 2 cables, 5-pin | 192010 | SEA-5GS-11-DUO | |
| | | M12, 5-pin | 175487 | SEA-M12-5GS-PG7 | |
| Connecting cable | | | | | |
|  | Modular system for a choice of connecting cables | | – | NEBU-... → Internet: nebu | |
| User documentation | | | | | |
|  | User documentation for PROFI-safe input module | German | 8035496 | CPX-F8DE-P-DE | |
| | | English | 8035497 | CPX-F8DE-P-EN | |
| | | Spanish | 8035498 | CPX-F8DE-P-ES | |
| | | French | 8035499 | CPX-F8DE-P-FR | |
| | | Italian | 8035500 | CPX-F8DE-P-IT | |
| | | Chinese | 8035501 | CPX-F8DE-P-ZH | |

Data sheet – Input module, digital, 16 inputs

Function

Digital input modules enable the connection of two-wire and three-wire sensors (proximity switches, inductive or capacitive sensors, etc.).

Depending on the connection block selected, the module supports various connection concepts with different numbers of sockets (single or double allocation).

Area of application

- Input modules for 24 V DC sensor supply voltage
- PNP logic
- Module features can be parameterised
- The input module receives the supply voltage for the electronics and the sensors from the interlinking block
- Module protection and diagnostics through integrated electronic protection

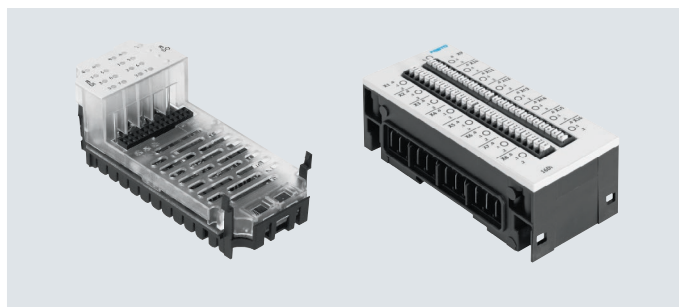

| General technical data | | CPX-16DE | CPX-M-16DE-D | CPX-L-16DE |
|--|------------------------|--|---|-------------------------------------|
| Type | | | | |
| Number of inputs | | 16 | 16 | 16 |
| Max. residual current of inputs per module | [A] | 1.8 | 1.8 | 1.8 |
| Intrinsic current consumption at operating voltage | [mA] | Typically 15 | Typically 34 | Typically 15 |
| Fuse protection | | Internal electronic fuse per module | Internal electronic fuse per channel pair, additional safety fuse | Internal electronic fuse per module |
| Nominal operating voltage | [V DC] | 24 | 24 | 24 |
| Operating voltage range | [V DC] | 18 ... 30 | 18 ... 30 | 18 ... 30 |
| Galvanic isolation | Channel – channel | No | No | No |
| | Channel – internal bus | No | No | No |
| Switching level | Signal 0 | [V DC] ≤ 5 | ≤ 5 | ≤ 5 |
| | Signal 1 | [V DC] ≥ 11 | ≥ 11 | ≥ 15 |
| Input debounce time | [ms] | 3 (0.1 ms, 10 ms, 20 ms parameterisable) | | |
| Input characteristic | | IEC 1131-T2 | IEC 1131-T2 | IEC 1131-T2, type 01 |
| Switching logic | | Positive logic (PNP) | Positive logic (PNP) | Positive logic (PNP) |
| LED displays | Group diagnostics | 1 | 1 | 1 |
| | Channel diagnostics | – | 16 | – |
| | Channel status | 16 | 16 | 16 |
| Diagnostics | | Short circuit/overload per channel | | |
| Parameterisation | | <ul style="list-style-type: none"> • Module monitoring • Behaviour after short circuit • Input debounce time • Signal extension time | | |
| Degree of protection to EN 60529 | | Depending on connection block | Depending on connection block | IP20 |
| Temperature range | Operation | [°C] –5 ... +50 | –5 ... +50 | –5 ... +50 |
| | Storage/transport | [°C] –20 ... +70 | –20 ... +70 | –20 ... +70 |
| Certification | | – | – | c UL us - Listed (OL) |
| Materials | | Reinforced PA, PC | Reinforced PA, PC | PA-reinforced |
| Note on materials | | – | – | RoHS-compliant |
| PWIS conformity | | VDMA24364-B2-L | VDMA24364-B2-L | VDMA24364-B2-L |
| Grid dimension | [mm] | 50 | 50 | 50 |
| Dimensions (including interlinking block and connection block) W x L x H | [mm] | 50 x 107 x 50 | 50 x 107 x 50 | 50 x 107 x 41 |
| Product weight | [g] | 41 | 46 | 167 |

Data sheet – Input module, digital, 16 inputs

Connection and display components

CPX-16DE

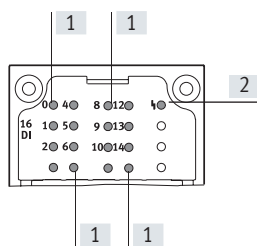

- [1] Status LEDs (green): for allocation to the inputs → pin allocation of the module
- [2] Error LED (red, module error)

CPX-M-16DE-D

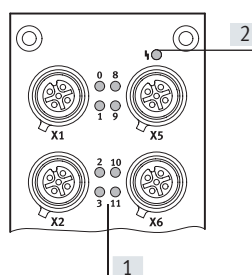

- [1] Common status LEDs (green)/error LEDs (red) for each input signal
- [2] Error LED (red, module error)

CPX-L-16DE

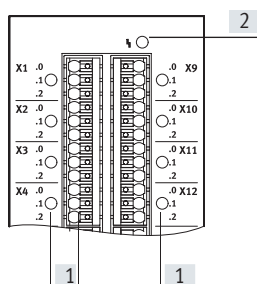

- [1] Status LEDs (green) for each input signal
- [2] Error LED (red, module error)









Combinations of connection blocks and digital input modules

| Connection blocks | Part no. | Digital input modules | | |
|-----------------------|----------|-----------------------|--------------|------------|
| | | CPX-16DE | CPX-M-16DE-D | CPX-L-16DE |
| CPX-AB-8-M8X2-4POL | 541256 | ■ | – | – |
| CPX-AB-8-M12X2-5POL | 3606900 | – | ■ | – |
| CPX-AB-8-KL-4POL | 195708 | ■ | – | – |
| CPX-AB-1-SUB-BU-25POL | 525676 | ■ | – | – |
| CPX-M-AB-8-M12X2-5POL | 549335 | – | ■ | – |

Data sheet – Input module, digital, 16 inputs

| Pin allocation | | CPX-16DE |
|------------------------------|---|---|
| Connection block inputs | | |
| CPX-AB-8-M8x2-4POL | | |
| | <p>X1.1: 24 V_{SEN} X1.2: Input x+1 X1.3: 0 V_{SEN} X1.4: Input x X2.1: 24 V_{SEN} X2.2: Input x+3 X2.3: 0 V_{SEN} X2.4: Input x+2 X3.1: 24 V_{SEN} X3.2: Input x+5 X3.3: 0 V_{SEN} X3.4: Input x+4 X4.1: 24 V_{SEN} X4.2: Input x+7 X4.3: 0 V_{SEN} X4.4: Input x+6</p> | <p>X5.1: 24 V_{SEN} X5.2: Input x+9 X5.3: 0 V_{SEN} X5.4: Input x+8 X6.1: 24 V_{SEN} X6.2: Input x+11 X6.3: 0 V_{SEN} X6.4: Input x+10 X7.1: 24 V_{SEN} X7.2: Input x+13 X7.3: 0 V_{SEN} X7.4: Input x+12 X8.1: 24 V_{SEN} X8.2: Input x+15 X8.3: 0 V_{SEN} X8.4: Input x+14</p> |
| CPX-AB-8-KL-4POL | | |
| | <p>X1.0: Input x+8 X1.1: 24 V_{SEN} X1.2: Input x X1.3: FE X2.0: Input x+9 X2.1: 24 V_{SEN} X2.2: Input x+1 X2.3: FE X3.0: Input x+10 X3.1: 24 V_{SEN} X3.2: Input x+2 X3.3: FE X4.0: Input x+11 X4.1: 24 V_{SEN} X4.2: Input x+3 X4.3: FE</p> | <p>X5.0: Input x+12 X5.1: 0 V_{SEN} X5.2: Input x+4 X5.3: FE X6.0: Input x+13 X6.1: 0 V_{SEN} X6.2: Input x+5 X6.3: FE X7.0: Input x+14 X7.1: 0 V_{SEN} X7.2: Input x+6 X7.3: FE X8.0: Input x+15 X8.1: 0 V_{SEN} X8.2: Input x+7 X8.3: FE</p> |
| CPX-AB-1-SUB-BU-25POL | | |
| | <p>1: Input x 2: Input x+1 3: Input x+2 4: Input x+3 5: Input x+9 6: 24 V_{SEN} 7: Input x+11 8: 24 V_{SEN} 9: Input x+8 10: Input x+10 11: 24 V_{SEN} 12: 24 V_{SEN} 13: FE</p> | <p>14: Input x+4 15: Input x+5 16: Input x+6 17: Input x+7 18: Input x+12 19: Input x+13 20: Input x+14 21: Input x+15 22: 0 V_{SEN} 23: 0 V_{SEN} 24: 0 V_{SEN} 25: FE Housing: FE</p> |



Data sheet – Input module, digital, 16 inputs

| Pin allocation | | CPX-M-16DE-D | |
|---|---|---|---|
| Connection block inputs | | CPX-M-16DE-D | |
| CPX-M-AB-8-M12X2-5POL and CPX-AB-8-M12X2-5POL | | | |
|  |  | X1.1: $24 V_{Sx}$ X1.2: Input x+1 X1.3: $0 V_{Sx}$ X1.4: Input x X1.5: FE | X5.1: $24 V_{Sx+8}$ X5.2: Input x+9 X5.3: $0 V_{Sx+8}$ X5.4: Input x+8 X5.5: FE |
|  |  | X2.1: $24 V_{Sx+2}$ X2.2: Input x+3 X2.3: $0 V_{Sx+2}$ X2.4: Input x+2 X2.5: FE | X6.1: $24 V_{Sx+10}$ X6.2: Input x+11 X6.3: $0 V_{Sx+10}$ X6.4: Input x+10 X6.5: FE |
|  |  | X3.1: $24 V_{Sx+4}$ X3.2: Input x+5 X3.3: $0 V_{Sx+4}$ X3.4: Input x+4 X3.5: FE | X7.1: $24 V_{Sx+12}$ X7.2: Input x+13 X7.3: $0 V_{Sx+12}$ X7.4: Input x+12 X7.5: FE |
|  |  | X4.1: $24 V_{Sx+6}$ X4.2: Input x+7 X4.3: $0 V_{Sx+6}$ X4.4: Input x+6 X4.5: FE | X8.1: $24 V_{Sx+14}$ X8.2: Input x+15 X8.3: $0 V_{Sx+14}$ X8.4: Input x+14 X8.5: FE |

Data sheet – Input module, digital, 16 inputs

| Pin allocation | | CPX-L-16DE | |
|-------------------------|--|---------------------------|----------------------------|
| Connection block inputs | | | |
| | <p>X1 .0 .1 .2</p> <p>X2 .0 .1 .2</p> <p>X3 .0 .1 .2</p> <p>X4 .0 .1 .2</p> <p>X5 .0 .1 .2</p> <p>X6 .0 .1 .2</p> <p>X7 .0 .1 .2</p> <p>X8 .0 .1 .2</p> <p>X9 .0 .1 .2</p> <p>X10 .0 .1 .2</p> <p>X11 .0 .1 .2</p> <p>X12 .0 .1 .2</p> <p>X13 .0 .1 .2</p> <p>X14 .0 .1 .2</p> <p>X15 .0 .1 .2</p> <p>X16 .0 .1 .2</p> | X1.0: 24 V _{SEN} | X9.0: 24 V _{SEN} |
| | | X1.1: Input x | X9.1: Input x+8 |
| | | X1.2: 0 V _{SEN} | X9.2: 0 V _{SEN} |
| | | X2.0: 24 V _{SEN} | X10.0: 24 V _{SEN} |
| | | X2.1: Input x+1 | X10.1: Input x+9 |
| | | X2.2: 0 V _{SEN} | X10.2: 0 V _{SEN} |
| | | X3.0: 24 V _{SEN} | X11.0: 24 V _{SEN} |
| | | X3.1: Input x+2 | X11.1: Input x+10 |
| | | X3.2: 0 V _{SEN} | X11.2: 0 V _{SEN} |
| | | X4.0: 24 V _{SEN} | X12.0: 24 V _{SEN} |
| | | X4.1: Input x+3 | X12.1: Input x+11 |
| | | X4.2: 0 V _{SEN} | X12.2: 0 V _{SEN} |
| | | X5.0: 24 V _{SEN} | X13.0: 24 V _{SEN} |
| | | X5.1: Input x+4 | X13.1: Input x+12 |
| | | X5.2: 0 V _{SEN} | X13.2: 0 V _{SEN} |
| | | X6.0: 24 V _{SEN} | X14.0: 24 V _{SEN} |
| | | X6.1: Input x+5 | X14.1: Input x+13 |
| | | X6.2: 0 V _{SEN} | X14.2: 0 V _{SEN} |
| | | X7.0: 24 V _{SEN} | X15.0: 24 V _{SEN} |
| | | X7.1: Input x+6 | X15.1: Input x+14 |
| | | X7.2: 0 V _{SEN} | X15.2: 0 V _{SEN} |
| | | X8.0: 24 V _{SEN} | X16.0: 24 V _{SEN} |
| | | X8.1: Input x+7 | X16.1: Input x+15 |
| | | X8.2: 0 V _{SEN} | X16.2: 0 V _{SEN} |

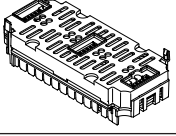
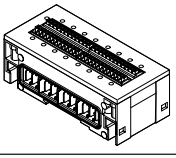
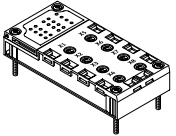
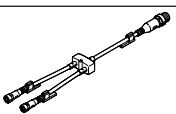
Data sheet – Input module, digital, 16 inputs

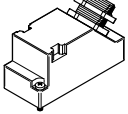
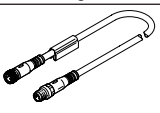
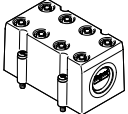
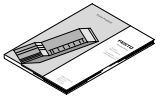
| Ordering data | | Part no. | Type | |
|---|--|--------------------------------|-----------------------|------------------------------|
| Designation | | | | |
| Input module, digital | | | | |
|  | 16 digital inputs, internal electronic fuse per module | 543815 | CPX-16DE | |
| | 16 digital inputs, internal electronic fuse per channel pair, for CPX in metal | 550202 | CPX-M-16DE-D | |
|  | 16 digital inputs, internal electronic fuse per module, for CPX in plastic, including interlinking block and connection block with spring-loaded terminals | 572606 | CPX-L-16DE-16-KL-3POL | |
| Connection block | | | | |
|  | Plastic | 8x socket M8, 4-pin | 541256 | CPX-AB-8-M8X2-4POL |
| | | 8x socket M12, 5-pin | 3606900 | CPX-AB-8-M12X2-5POL |
| | | Spring-loaded terminal, 32-pin | 195708 | CPX-AB-8-KL-4POL |
| | | 1x socket, Sub-D, 25-pin | 525676 | CPX-AB-1-SUB-BU-25POL |
| | Metal | 8x socket M12, 5-pin | 549335 | CPX-M-AB-8-M12X2-5POL |
| Distributor | | | | |
|  | Modular system for all types of sensor/actuator distributor | | – | NEDY-... → Internet: nedy |
|  | 1x plug M8, 4-pin | 2x socket M8, 3-pin | 8005312 | NEDY-L2R1-V1-M8G3-N-M8G4 |
| Plug | | | | |
|  | Plug M8, 3-pin | Solderable | 18696 | SEA-GS-M8 |
| | | Screw-in | 192009 | SEA-3GS-M8-S |
|  | Sub-D plug, 25-pin | | 527522 | SD-SUB-D-ST25 |
| Connecting cable | | | | |
|  | Connecting cable M8-M8 | 0.5 m | 541346 | NEBU-M8G3-K-0.5-M8G3 |
| | | 1.0 m | 541347 | NEBU-M8G3-K-1-M8G3 |
| | | 2.5 m | 541348 | NEBU-M8G3-K-2.5-M8G3 |
| | | 5.0 m | 541349 | NEBU-M8G3-K-5-M8G3 |
| | Modular system for a choice of connecting cables | | – | NEBU-... → Internet: nebu |
| Cover | | | | |
|  | Cover for CPX-AB-8-KL-4POL (IP65, IP67) • 8 cable through feeds M9 • 1 cable through feed for multi-pin plug | | 538219 | AK-8KL |
| | Fittings kit | | 538220 | VG-K-M9 |
| User documentation | | | | |
|  | User documentation | German | 526439 | P.BE-CPX-EA-DE |
| | | English | 526440 | P.BE-CPX-EA-EN |
| | | Spanish | 526441 | P.BE-CPX-EA-ES |
| | | French | 526442 | P.BE-CPX-EA-FR |
| | | Italian | 526443 | P.BE-CPX-EA-IT |

Data sheet – Output module, digital

Function

Digital outputs control actuators such as individual valves, hydraulic valves, heating controllers and many more. Separate circuits are created using an additional supply. Parallel connection of the outputs of a module enables consuming devices to be controlled with up to 4 A.

Area of application

- Output module for 24 V DC supply voltage
- PNP logic
- Module features can be parameterised
- The output module receives the voltage supply for the electronics and the outputs from the interlinking block
- Module protection and diagnostics through integrated electronic protection in each channel

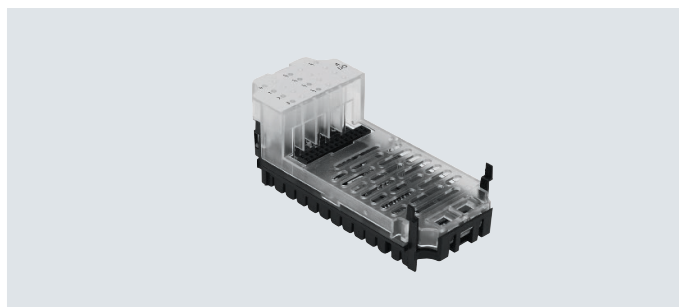

| General technical data | | | CPX-4DA | CPX-8DA | CPX-8DA-H |
|--|------------------------|--------|---|---|--|
| Type | | | | | |
| Number of outputs | | | 4 | 8 | 8 |
| Max. power supply | Per module | [A] | 4 | | 8.4 |
| | Per channel | [A] | 1 (24 W lamp load, 4 channels can be connected in parallel) | 0.5 (12 W lamp load, 8 channels can be connected in parallel) | 2.1 (50 W lamp load), per channel pair |
| Fuse protection (short circuit) | | | Internal electronic fuse per channel | | |
| Module current consumption (power supply for electronics) | | [mA] | Typically 16 | | Typically 34 |
| Operating voltage | Nominal value | [V DC] | 24 | | |
| | Permissible range | [V DC] | 18 ... 30 | | |
| Galvanic isolation | Channel – channel | | No | | |
| | Channel – internal bus | | Yes, with intermediate supply | | |
| Output characteristic | | | Based on IEC 1131-2 | | |
| Switching logic | | | Positive logic (PNP) | | |
| LED displays | Group diagnostics | | 1 | 1 | 1 |
| | Channel diagnostics | | 4 | 8 | 8 |
| | Channel status | | 4 | 8 | 8 |
| Diagnostics | | | <ul style="list-style-type: none"> • Short circuit/overload, channel x • Undervoltage of outputs | | |
| Parameterisation | | | <ul style="list-style-type: none"> • Module monitoring • Behaviour after short circuit • Fail-safe channel x • Forcing channel x • Idle mode channel x | | |
| Degree of protection to EN 60529 | | | Depending on connection block | | |
| Temperature range | Operation | [°C] | –5 ... +50 | | |
| | Storage/transport | [°C] | –20 ... +70 | | |
| Materials | | | Reinforced PA, PC | | |
| PWIS conformity | | | VDMA24364-B2-L | | |
| Grid dimension | | [mm] | 50 | | |
| Dimensions (including interlinking block and connection block) W x L x H | | [mm] | 50 x 107 x 50 | | |
| Product weight | | [g] | 42 | 49 | 48 |

Data sheet – Output module, digital

Connection and display components

CPX-4DA

CPX-8DA

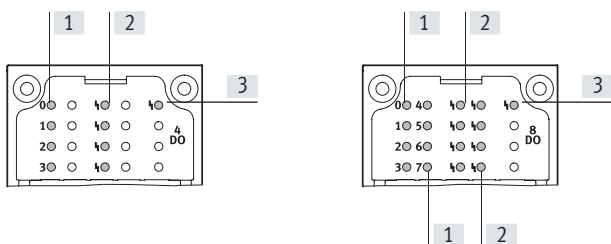

- [1] Status LEDs (yellow): for allocation to outputs → pin allocation of the module
 [2] Channel-related error LEDs (red)
 [3] Error LED (red, module error)

Combinations of connection block and digital output module

| Connection blocks | Part no. | Digital output module | | |
|-----------------------|----------|-----------------------|---------|-----------|
| | | CPX-4DA | CPX-8DA | CPX-8DA-H |
| CPX-AB-8-M8-3POL | 195706 | ■ | ■ | – |
| CPX-AB-8-M8X2-4POL | 541256 | ■ | ■ | ■ |
| CPX-AB-4-M12X2-5POL | 195704 | ■ | ■ | – |
| CPX-AB-4-M12X2-5POL-R | 541254 | ■ | ■ | ■ |
| CPX-AB-8-KL-4POL | 195708 | ■ | ■ | ■ |
| CPX-AB-1-SUB-BU-25POL | 525676 | ■ | ■ | ■ |
| CPX-M-AB-4-M12X2-5POL | 549367 | ■ | ■ | ■ |

Pin allocation

| Connection block outputs | CPX-4DA | CPX-8DA |
|--------------------------|--|--|
| CPX-AB-8-M8-3POL | | |
| | X1.1: n.c. X1.3: 0 V _{OUT} X1.4: Output x | X5.1: n.c. X5.3: 0 V _{OUT} X5.4: Output x+2 |
| | X2.1: n.c. X2.3: 0 V _{OUT} X2.4: Output x+1 | X6.1: n.c. X6.3: 0 V _{OUT} X6.4: Output x+3 |
| | X3.1: n.c. X3.3: 0 V _{OUT} X3.4: Output x+1 | X7.1: n.c. X7.3: 0 V _{OUT} X7.4: Output x+3 |
| | X4.1: n.c. X4.3: 0 V _{OUT} X4.4: n.c. | X8.1: n.c. X8.3: 0 V _{OUT} X8.4: n.c. |
| | | X1.1: n.c. X1.3: 0 V _{OUT} X1.4: Output x |
| | | X5.1: n.c. X5.3: 0 V _{OUT} X5.4: Output x+4 |
| | | X2.1: n.c. X2.3: 0 V _{OUT} X2.4: Output x+1 |
| | | X6.1: n.c. X6.3: 0 V _{OUT} X6.4: Output x+5 |
| | | X3.1: n.c. X3.3: 0 V _{OUT} X3.4: Output x+2 |
| | | X7.1: n.c. X7.3: 0 V _{OUT} X7.4: Output x+6 |
| | | X4.1: n.c. X4.3: 0 V _{OUT} X4.4: Output x+3 |
| | | X8.1: n.c. X8.3: 0 V _{OUT} X8.4: Output x+7 |

Data sheet – Output module, digital



| Pin allocation | | CPX-4DA | | CPX-8DA and CPX-8DA-H | |
|--|--|--|--|--|--|
| Connection block outputs | | CPX-4DA | | CPX-8DA and CPX-8DA-H | |
| CPX-AB-8-M8X2-4POL | | | | | |
| | | X1.1: 0 V _{OUT} X1.2: Output x+1 X1.3: 0 V _{OUT} X1.4: Output x X2.1: 0 V _{OUT} X2.2: n.c. X2.3: 0 V _{OUT} X2.4: Output x+1 X3.1: 0 V _{OUT} X3.2: Output x+3 X3.3: 0 V _{OUT} X3.4: Output x+2 X4.1: 0 V _{OUT} X4.2: n.c. X4.3: 0 V _{OUT} X4.4: Output x+3 | X5.1: 0 V _{OUT} X5.2: n.c. X5.3: 0 V _{OUT} X5.4: n.c. X6.1: 0 V _{OUT} X6.2: n.c. X6.3: 0 V _{OUT} X6.4: n.c. X7.1: 0 V _{OUT} X7.2: n.c. X7.3: 0 V _{OUT} X7.4: n.c. X8.1: 0 V _{OUT} x+1 X8.2: n.c. X8.3: 0 V _{OUT} x+3 X8.4: n.c. | X1.1: 0 V _{OUT} X1.2: Output x+1 X1.3: 0 V _{OUT} X1.4: Output x X2.1: 0 V _{OUT} X2.2: Output x+3 X2.3: 0 V _{OUT} X2.4: Output x+2 X3.1: 0 V _{OUT} X3.2: Output x+5 X3.3: 0 V _{OUT} X3.4: Output x+4 X4.1: 0 V _{OUT} X4.2: Output x+7 X4.3: 0 V _{OUT} X4.4: Output x+6 | X5.1: 0 V _{OUT} X5.2: n.c. X5.3: 0 V _{OUT} X5.4: n.c. X6.1: 0 V _{OUT} X6.2: n.c. X6.3: 0 V _{OUT} X6.4: n.c. X7.1: 0 V _{OUT} X7.2: n.c. X7.3: 0 V _{OUT} X7.4: n.c. X8.1: 0 V _{OUT} X8.2: n.c. X8.3: 0 V _{OUT} X8.4: n.c. |
| CPX-AB-4-M12X2-5POL¹⁾ and CPX-AB-4-M12X2-5POL-R²⁾ | | | | | |
| | | X1.1: n.c. X1.2: Output x+1 X1.3: 0 V _{OUT} X1.4: Output x X1.5: FE X2.1: n.c. X2.2: n.c. X2.3: 0 V _{OUT} X2.4: Output x+1 X2.5: FE | X3.1: n.c. X3.2: Output x+3 X3.3: 0 V _{OUT} X3.4: Output x+2 X3.5: FE X4.1: n.c. X4.2: n.c. X4.3: 0 V _{OUT} X4.4: Output x+3 X4.5: FE | X1.1: n.c. X1.2: Output x+1 X1.3: 0 V _{OUT} X1.4: Output x X1.5: FE X2.1: n.c. X2.2: Output x+3 X2.3: 0 V _{OUT} X2.4: Output x+2 X2.5: FE | X3.1: n.c. X3.2: Output x+5 X3.3: 0 V _{OUT} X3.4: Output x+4 X3.5: FE X4.1: n.c. X4.2: Output x+7 X4.3: 0 V _{OUT} X4.4: Output x+6 X4.5: FE |
| CPX-AB-8-KL-4POL | | | | | |
| | | X1.0: n.c. X1.1: 0 V _{OUT} X1.2: Output x X1.3: FE X2.0: n.c. X2.1: 0 V _{OUT} X2.2: Output x+1 X2.3: FE X3.0: n.c. X3.1: 0 V _{OUT} X3.2: Output x+1 X3.3: FE X4.0: n.c. X4.1: 0 V _{OUT} X4.2: n.c. X4.3: FE | X5.0: n.c. X5.1: 0 V _{OUT} X5.2: Output x+2 X5.3: FE X6.0: n.c. X6.1: 0 V _{OUT} X6.2: Output x+3 X6.3: FE X7.0: n.c. X7.1: 0 V _{OUT} X7.2: Output x+3 X7.3: FE X8.0: n.c. X8.1: 0 V _{OUT} X8.2: n.c. X8.3: FE | X1.0: n.c. X1.1: 0 V _{OUT} X1.2: Output x X1.3: FE X2.0: n.c. X2.1: 0 V _{OUT} X2.2: Output x+1 X2.3: FE X3.0: n.c. X3.1: 0 V _{OUT} X3.2: Output x+2 X3.3: FE X4.0: n.c. X4.1: 0 V _{OUT} X4.2: Output x+3 X4.3: FE | X5.0: n.c. X5.1: 0 V _{OUT} X5.2: Output x+4 X5.3: FE X6.0: n.c. X6.1: 0 V _{OUT} X6.2: Output x+5 X6.3: FE X7.0: n.c. X7.1: 0 V _{OUT} X7.2: Output x+6 X7.3: FE X8.0: n.c. X8.1: 0 V _{OUT} X8.2: Output x+7 X8.3: FE |

1) Not suitable for CPX-8DA-H.
 2) Speedcon quick lock, additional shielding on metal thread

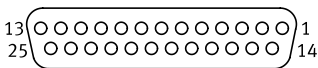

Data sheet – Output module, digital

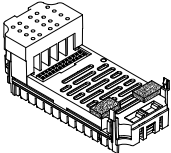
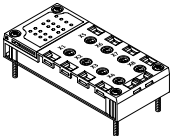
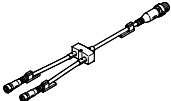
| Pin allocation | | CPX-4DA | | CPX-8DA and CPX-8DA-H | |
|---|--|------------------------|------------------------|------------------------|------------------------|
| Connection block outputs | | CPX-4DA | | CPX-8DA and CPX-8DA-H | |
| CPX-AB-1-SUB-BU-25POL | | | | | |
|  | | 1: Output x | 14: Output x+2 | 1: Output x | 14: Output x+4 |
| | | 2: Output x+1 | 15: Output x+3 | 2: Output x+1 | 15: Output x+5 |
| | | 3: Output x+1 | 16: Output x+3 | 3: Output x+2 | 16: Output x+6 |
| | | 4: n.c. | 17: n.c. | 4: Output x+3 | 17: Output x+7 |
| | | 5: n.c. | 18: n.c. | 5: n.c. | 18: n.c. |
| | | 6: 0 V _{OUT} | 19: n.c. | 6: 0 V _{OUT} | 19: n.c. |
| | | 7: n.c. | 20: n.c. | 7: n.c. | 20: n.c. |
| | | 8: 0 V _{OUT} | 21: n.c. | 8: 0 V _{OUT} | 21: n.c. |
| | | 9: n.c. | 22: 0 V _{OUT} | 9: n.c. | 22: 0 V _{OUT} |
| | | 10: n.c. | 23: 0 V _{OUT} | 10: n.c. | 23: 0 V _{OUT} |
| | | 11: 0 V _{OUT} | 24: 0 V _{OUT} | 11: 0 V _{OUT} | 24: 0 V _{OUT} |
| | | 12: 0 V _{OUT} | 25: FE | 12: 0 V _{OUT} | 25: FE |
| | | 13: FE | Housing: FE | 13: FE | Housing: FE |

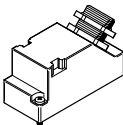
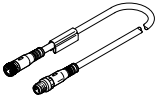
Data sheet – Output module, digital

| Ordering data | | Part no. | Type | | |
|--|---|--|------------|------------------------------|------------------------------|
| Designation | | | | | |
| Output module, digital | | | | | |
|  | 4 digital outputs, power supply 1 A per channel | 195754 | CPX-4DA | | |
| | 8 digital outputs, power supply 0.5 A per channel | 541482 | CPX-8DA | | |
| | 8 digital outputs, power supply 2.1 A per channel pair | 550204 | CPX-8DA-H | | |
| Connection block | | | | | |
|  | Plastic | 8x socket M8, 3-pin | 195706 | CPX-AB-8-M8-3POL | |
| | | 8x socket M8, 4-pin | 541256 | CPX-AB-8-M8X2-4POL | |
| | | 4x socket M12, 5-pin | 195704 | CPX-AB-4-M12X2-5POL | |
| | | 4x socket, M12 with quick-lock technology, 5-pin | 541254 | CPX-AB-4-M12X2-5POL-R | |
| | | Spring-loaded terminal, 32-pin | 195708 | CPX-AB-8-KL-4POL | |
| | | 1x socket, Sub-D, 25-pin | 525676 | CPX-AB-1-SUB-BU-25POL | |
| | Metal | 4x socket M12, 5-pin | 549367 | CPX-M-AB-4-M12X2-5POL | |
| Distributor | | | | | |
|  | Modular system for all types of sensor/actuator distributor | | – | NEDY-... → Internet: nedy | |
|  | 1x plug M8, 4-pin | 2x socket M8, 3-pin | 8005312 | NEDY-L2R1-V1-M8G3-N-M8G4 | |
| | 1x plug M12, 4-pin | 2x socket M8, 3-pin | 8005311 | NEDY-L2R1-V1-M8G3-N-M12G4 | |
| | | 2x socket M12, 5-pin | 8005310 | NEDY-L2R1-V1-M12G5-N-M12G4 | |
| Plug | | | | | |
|  | Plug | M8 3-pin | Solderable | 18696 | SEA-GS-M8 |
| | | | Screw-in | 192009 | SEA-3GS-M8-S |
| | | M12, PG7 | | 18666 | SEA-GS-7 |
| | | M12, PG7, 4-pin for cable ø 2.5 mm | | 192008 | SEA-4GS-7-2.5 |
| | | M12, PG9 | | 18778 | SEA-GS-9 |
| | | M12 for 2 cables | | 18779 | SEA-GS-11-DUO |
| | | M12 for 2 cables, 5-pin | | 192010 | SEA-5GS-11-DUO |
|  | Sub-D plug, 25-pin | | | 175487 | SEA-M12-5GS-PG7 |
| | | | | 527522 | SD-SUB-D-ST25 |
| Connecting cable | | | | | |
|  | Connecting cable M8-M8 | 0.5 m | 541346 | NEBU-M8G3-K-0.5-M8G3 | |
| | | 1.0 m | 541347 | NEBU-M8G3-K-1-M8G3 | |
| | | 2.5 m | 541348 | NEBU-M8G3-K-2.5-M8G3 | |
| | | 5.0 m | 541349 | NEBU-M8G3-K-5-M8G3 | |
| | Modular system for a choice of connecting cables | | – | | NEBU-... → Internet: nebu |

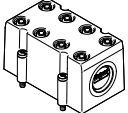
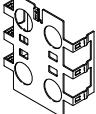
Data sheet – Output module, digital

| Ordering data | | Part no. | Type | |
|---|--|----------|----------------|----------------|
| Designation | | | | |
| Cover | | | | |
|  | Cover for CPX-AB-8-KL-4POL (IP65, IP67) • 8 cable through feeds M9 • 1 cable through feed for multi-pin plug | 538219 | AK-8KL | |
| | Fittings kit | 538220 | VG-K-M9 | |
| Screening plate | | | | |
|  | Screening plate for M12 connections | 526184 | CPX-AB-S-4-M12 | |
| User documentation | | | | |
|  | User documentation | German | 526439 | P.BE-CPX-EA-DE |
| | | English | 526440 | P.BE-CPX-EA-EN |
| | | Spanish | 526441 | P.BE-CPX-EA-ES |
| | | French | 526442 | P.BE-CPX-EA-FR |
| | | Italian | 526443 | P.BE-CPX-EA-IT |

Data sheet – Input/output module, digital

Area of application

- Digital multi I/O module for 24 V DC supply voltage
- Supports connection blocks with Sub-D, terminal connection and M12 connection (8-pin)
- As CPX-L with connection via spring-loaded terminals
- Module features can be parameterised
- The inputs receive the voltage supply for the electronics and the sensors from the interlinking block
- The outputs receive the voltage supply for the electronics and the outputs from the interlinking block
- Module protection and diagnostics through integrated electronic fuse protection for the sensor power supply and integrated electronic fuse protection in each output channel

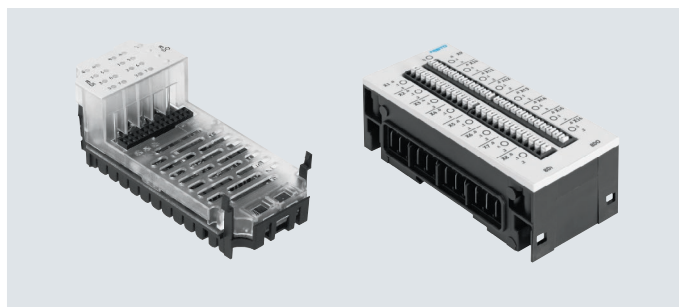

| General technical data | | | CPX-8DE-8DA | CPX-L-8DE-8DA |
|---|------------------------|--------|--|------------------------|
| Type | | | | |
| Number | Inputs | | 8 | 8 |
| | Outputs | | 8 | 8 |
| Max. power supply Per module | Sensor supply | [A] | 0.7 | 1.8 |
| | Outputs | [A] | 4 | 2 |
| Max. power supply per channel | | [A] | 0.5 (12 W lamp load, channels A0 ... A03 can be connected in parallel to A4 ... A7) | 0.25 (6 W lamp load) |
| Fuse protection (short circuit) | | | Internal electronic fuse per channel | |
| Intrinsic current consumption at nominal operating voltage | | [mA] | Typically 22 | Typically 15 |
| Operating voltage | Nominal value | [V DC] | 24 | 24 |
| | Permissible range | [V DC] | 18 ... 30 | 18 ... 30 |
| Galvanic isolation, inputs | Channel – channel | | No | No |
| | Channel – internal bus | | No | No |
| Galvanic isolation, outputs | Channel – channel | | No | No |
| | Channel – internal bus | | Yes, with intermediate supply | No |
| Characteristic curve | Inputs | | IEC 1131-T2 | IEC 1131-T2, type 01 |
| | Outputs | | IEC 1131-T2 | IEC 1131-T2 |
| Switching level, inputs | Signal 0 | [V DC] | ≤ 5 | ≤ 5 |
| | Signal 1 | [V DC] | ≥ 11 | ≥ 15 |
| Input debounce time | | [ms] | 3 (0.1 ms, 10 ms, 20 ms parameterisable) | |
| Switching logic | | | Positive logic (PNP) | Positive logic (PNP) |
| LED displays | Group diagnostics | | 1 | 1 |
| | Channel diagnostics | | – | – |
| | Channel status | | 16 | 16 |
| Diagnostics | | | <ul style="list-style-type: none"> • Short circuit/overload per channel • Undervoltage of outputs | |
| Parameterisation | | | <ul style="list-style-type: none"> • Input debounce time • Failsafe per channel • Forcing per channel • Idle mode per channel • Signal extension time • Module monitoring • Behaviour after short circuit | |
| Degree of protection to EN 60529 | | | Depending on connection block | IP20 |
| Temperature range | Operation | [°C] | –5 ... +50 | –5 ... +50 |
| | Storage/transport | [°C] | –20 ... +70 | –20 ... +70 |
| Certification | | | – | c UL - Recognized (OL) |
| Materials | | | Reinforced PA, PC | PA-reinforced |
| Note on materials | | | – | RoHS-compliant |
| PWIS conformity | | | VDMA24364-B2-L | VDMA24364-B2-L |
| Grid dimension | | [mm] | 50 | 50 |
| Dimensions (including interlinking block and connection block) W x L x H | | [mm] | 50 x 107 x 50 | 50 x 107 x 41 |
| Product weight | | [g] | 48 | 171 |

Data sheet – Input/output module, digital

Connection and display components

CPX-8DE-8DA

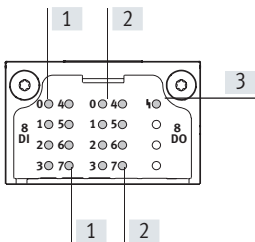

- [1] Status LEDs (green): for allocation to the inputs → pin allocation of the module
- [2] Status LEDs (yellow): for allocation to the inputs → pin allocation of the module
- [3] Error LED (red) (module error)

CPX-L-8DE-8DA

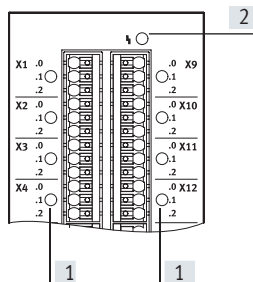

- [1] Status LEDs (green) for each input signal
- [2] Error LED (red, module error)

Connection block/digital I/O module combinations

| Connection blocks | Part no. | Digital I/O module | |
|-----------------------|----------|--------------------|---------------|
| | | CPX-8DE-8DA | CPX-L-8DE-8DA |
| CPX-AB-4-M12-8POL | 526178 | ■ | - |
| CPX-AB-8-KL-4POL | 195708 | ■ | - |
| CPX-AB-1-SUB-BU-25POL | 525676 | ■ | - |

Pin allocation

Connection block inputs/outputs

CPX-8DE-8DA

CPX-AB-4-M12-8POL

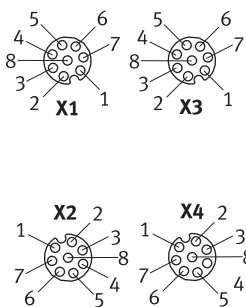

- X1.1: 24 V_{SEN}
- X1.2: Input x
- X1.3: Input x+1
- X1.4: 0 V_{SEN}
- X1.5: Output x
- X1.6: Output x+1
- X1.7: Input x+4
- X1.8: 0 V_{OUT}
- X2.1: 24 V_{SEN}
- X2.2: Input x+2
- X2.3: Input x+3
- X2.4: 0 V_{SEN}
- X2.5: Output x+2
- X2.6: Output x+3
- X2.7: Input x+6
- X2.8: 0 V_{OUT}

- X3.1: 24 V_{SEN}
- X3.2: Input x+4
- X3.3: Input x+5
- X3.4: 0 V_{SEN}
- X3.5: Output x+4
- X3.6: Output x+5
- X3.7: n.c.
- X3.8: 0 V_{OUT}
- X4.1: 24 V_{SEN}
- X4.2: Input x+6
- X4.3: Input x+7
- X4.4: 0 V_{SEN}
- X4.5: Output x+6
- X4.6: Output x+7
- X4.7: n.c.
- X4.8: 0 V_{OUT}

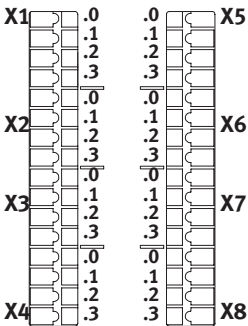
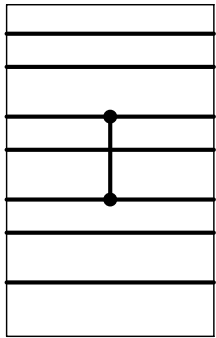

Data sheet – Input/output module, digital

| Pin allocation | | CPX-8DE-8DA |
|--|--|--|
| Connection block inputs/outputs | | |
| CPX-AB-8-KL-4POL | | |
|  | X1.0: 24 V _{SEN} X1.1: 0 V _{SEN} X1.2: Input x X1.3: FE X2.0: Input x+4 X2.1: Input x+5 X2.2: Input x+1 X2.3: FE X3.0: 24 V _{SEN} X3.1: 0 V _{SEN} X3.2: Input x+2 X3.3: FE X4.0: Input x+6 X4.1: Input x+7 X4.2: Input x+3 X4.3: FE | X5.0: Output x+4 X5.1: 0 V _{OUT} X5.2: Output x X5.3: FE X6.0: Output x+5 X6.1: 0 V _{OUT} X6.2: Output x+1 X6.3: FE X7.0: Output x+6 X7.1: 0 V _{OUT} X7.2: Output x+2 X7.3: FE X8.0: Output x+7 X8.1: 0 V _{OUT} X8.2: Output x+3 X8.3: FE |
| CPX-AB-1-SUB-BU-25POL | | |
|  | 0V Valves 24V Valves 0V Output 24V Output 0V El./Sen. 24V El./Sen. FE | 1: Input x 2: Input x+1 3: Input x+2 4: Input x+3 5: Input x+4 6: Input x+5 7: Input x+6 8: Input x+7 9: 24 V _{SEN} 10: 24 V _{SEN} 11: 0 V _{SEN} 12: 0 V _{SEN} 13: FE 14: Output x 15: Output x+1 16: Output x+2 17: Output x+3 18: Output x+4 19: Output x+5 20: Output x+6 21: Output x+7 22: 0 V _{OUT} 23: 0 V _{OUT} 24: 0 V _{OUT} 25: FE Housing: FE |

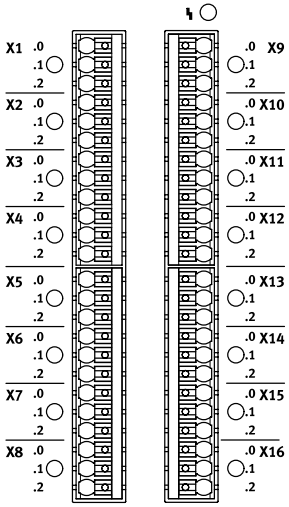
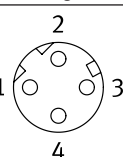
Data sheet – Input/output module, digital

| Pin allocation | | CPX-L-8DE-8DA | |
|---|---|--|--|
| Connection block inputs | | | |
|  | <p>X1.0: 24 V_{SEN}</p> <p>X1.1: Input x</p> <p>X1.2: 0 V_{SEN}+out</p> <p>X2.0: 24 V_{SEN}</p> <p>X2.1: Input x+1</p> <p>X2.2: 0 V_{SEN}+out</p> <p>X3.0: 24 V_{SEN}</p> <p>X3.1: Input x+2</p> <p>X3.2: 0 V_{SEN}+out</p> <p>X4.0: 24 V_{SEN}</p> <p>X4.1: Input x+3</p> <p>X4.2: 0 V_{SEN}+out</p> <p>X5.0: 24 V_{SEN}</p> <p>X5.1: Input x+4</p> <p>X5.2: 0 V_{SEN}+out</p> <p>X6.0: 24 V_{SEN}</p> <p>X6.1: Input x+5</p> <p>X6.2: 0 V_{SEN}+out</p> <p>X7.0: 24 V_{SEN}</p> <p>X7.1: Input x+6</p> <p>X7.2: 0 V_{SEN}+out</p> <p>X8.0: 24 V_{SEN}</p> <p>X8.1: Input x+7</p> <p>X8.2: 0 V_{SEN}+out</p> | <p>X9.0: 24 V_{SEN}</p> <p>X9.1: Output x</p> <p>X9.2: 0 V_{SEN}+out</p> <p>X10.0: 24 V_{SEN}</p> <p>X10.1: Output x+1</p> <p>X10.2: 0 V_{SEN}+out</p> <p>X11.0: 24 V_{SEN}</p> <p>X11.1: Output x+2</p> <p>X11.2: 0 V_{SEN}+out</p> <p>X12.0: 24 V_{SEN}</p> <p>X12.1: Output x+3</p> <p>X12.2: 0 V_{SEN}+out</p> <p>X13.0: 24 V_{SEN}</p> <p>X13.1: Output x+4</p> <p>X13.2: 0 V_{SEN}+out</p> <p>X14.0: 24 V_{SEN}</p> <p>X14.1: Output x+5</p> <p>X14.2: 0 V_{SEN}+out</p> <p>X15.0: 24 V_{SEN}</p> <p>X15.1: Output x+6</p> <p>X15.2: 0 V_{SEN}+out</p> <p>X16.0: 24 V_{SEN}</p> <p>X16.1: Output x+7</p> <p>X16.2: 0 V_{SEN}+out</p> | |
| Interlinking block | | CPX-L-8DE-8DA | |
|  | <p>The module combines the 0 V potential of the power supply for electronics and sensors with the 0 V potential of the power supply for outputs in the CPX interlinking module.</p> | <p>If all pins of the outputs of an output module connected to the right of the input/output module are to be switched off, an appropriate interlinking block with additional supply for outputs must be used to the right of the input/output module.</p> | |

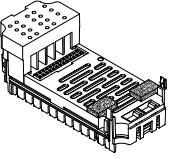
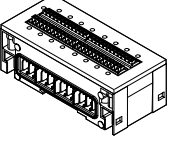
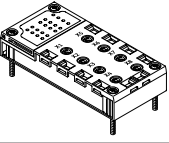
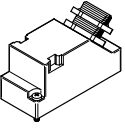
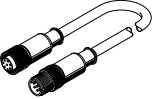
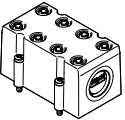
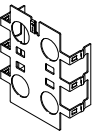
Data sheet – Input/output module, digital

| Ordering data | | Part no. | Type |
|--|--|--------------------------------|------------------------------|
| Designation | | | |
| Input/output module, digital | | | |
|  | 8 digital inputs, 8 digital outputs | 526257 | CPX-8DE-8DA |
|  | 8 digital inputs, 8 digital outputs, for CPX in plastic, including interlinking block and connection block with spring-loaded terminals | 572607 | CPX-L-8DE-8DA-16-KL-3POL |
| Connection block | | | |
|  | Plastic | 4x socket M12, 8-pin | 526178 CPX-AB-4-M12-8POL |
| | | Spring-loaded terminal, 32-pin | 195708 CPX-AB-8-KL-4POL |
| | | 1x socket, Sub-D, 25-pin | 525676 CPX-AB-1-SUB-BU-25POL |
| Plug | | | |
|  | Sub-D plug, 25-pin | 527522 | SD-SUB-D-ST25 |
| Connecting cable | | | |
|  | Connecting cable M12 | 525617 | KM12-8GD8GS-2-PU |
| Cover | | | |
|  | Cover for CPX-AB-8-KL-4POL (IP65, IP67) | 538219 | AK-8KL |
| | <ul style="list-style-type: none"> • 8 cable through feeds M9 • 1 cable through feed for multi-pin plug Fittings kit | 538220 | VG-K-M9 |
| Screening plate | | | |
|  | Screening plate for M12 connections | 526184 | CPX-AB-S-4-M12 |
| User documentation | | | |
|  | User documentation | German | 526439 P.BE-CPX-EA-DE |
| | | English | 526440 P.BE-CPX-EA-EN |
| | | Spanish | 526441 P.BE-CPX-EA-ES |
| | | French | 526442 P.BE-CPX-EA-FR |
| | | Italian | 526443 P.BE-CPX-EA-IT |

Data sheet – Counter module, digital

Function

The counter module has two channels. Depending on the parameterisation, these can independently be used as counter inputs or as incremental value encoder inputs or SSI. The counter module additionally has one output per channel. The outputs can either be controlled by a counter channel or an incremental value encoder channel, i.e. through an event such as "Comparative value reached". Alternatively, outputs can also be controlled via process data.

Area of application

- Continuous counting
- One-off counting to count limit
- One-off counting to count limit, return to load value
- Periodic counting
- Measurement of frequencies
- Measurement of rotational speeds
- Measurement of duty cycle
- Measurement of position
- Measurement of speed
- Measuring with pulse generators
- Measurement with pulse generators and direction encoders
- Measurement with incremental encoders
- Measurement with SSI absolute encoders



Description

Applications

- | | | | |
|---|--|---|---|
| <ul style="list-style-type: none"> • Recording travel and speed of a conveyor • Position and speed synchronisation of conveyors and pick & place applications • Counting goods e.g. in packaging installations | <ul style="list-style-type: none"> • Systems for filling by weight and volume • Monitoring motor speeds • Measuring equipment for determining the position of axis systems (linear, rotational) | <ul style="list-style-type: none"> • Controlling fast-switching valves • Controlling the opening time of a valve • Activating semiconductor relays | <ul style="list-style-type: none"> • Temperature monitoring and rotational speed control for drives • Change of direction in fast drives • Control of motors with pulse-width modulation (PWM) |
|---|--|---|---|

Supported devices

- | | | | |
|---|--|--|--|
| <ul style="list-style-type: none"> • 5 V incremental encoder, single-ended or differential, with two 90° phase offset tracks | <ul style="list-style-type: none"> • 24 V incremental encoder, single-ended, with two 90° phase offset tracks | <ul style="list-style-type: none"> • 24 V pulse generator with or without direction level • 24 V direct current motors | <ul style="list-style-type: none"> • Absolute encoder with SSI interface (13 bits to 25 bits) |
|---|--|--|--|

Data sheet – Counter module, digital

| General technical data | | CPX-2ZE2DA | |
|---|---|--|--|
| Type | | | |
| Number | Inputs | 2 | |
| | Outputs | 2 | |
| Max. power supply Per module | Inputs [A] | 2 | |
| | Outputs [A] | 10 | |
| Max. power supply per channel | [A] | 5 (adjustable, 20 W lamp load) | |
| Max. cable length | [m] | 30 | |
| Fuse protection (short circuit) | Internal electronic fuse per channel | | |
| Intrinsic current consumption at nominal operating voltage | [mA] | Typically 35 | |
| Operating voltage | Nominal value [V DC] | 24 | |
| | Permissible range [V DC] | 18 ... 30 | |
| Galvanic isolation, inputs | Channel – channel | No | |
| | Channel – internal bus | No | |
| Galvanic isolation, outputs | Channel – channel | No | |
| | Channel – internal bus | Yes, with intermediate supply | |
| Characteristic curve | Inputs | To IEC 1131-2, type O2 | |
| | Outputs | IEC 1131-T2 | |
| Switching level | Signal 0 [V DC] | ≤ 5 | |
| | Signal 1 [V DC] | ≥ 11 | |
| Input debounce time | [μs] | 0.1 (0.2 μs, 0.4 μs, 0.8 μs, 1 μs, 2 μs, 4 μs, 8 μs, 10 μs, 50 μs, 100 μs, 500 μs, 1 ms, 3 ms, 10 ms, 20 ms parameterisable) | |
| Switching logic | Inputs | Positive logic (PNP) | |
| | Outputs | <ul style="list-style-type: none"> • Negative logic (NPN) • Positive logic (PNP) • Push-pull driver | |
| LED displays | Group diagnostics | 1 | |
| | Channel diagnostics | 2 | |
| | Channel status | 10 | |
| | Module diagnostics | 2 | |
| Diagnostics | Operating mode-dependent diagnostics | | |
| Parameterisation | <ul style="list-style-type: none"> • Switch-on/off delay • Frequency output • Speed measurement • Impulse output • Pulse train • Rotational speed measurement • Frequency measurement • Period duration measurement • Motor operating mode • Determine position • Pulse width modulation • One-off counting • Continuous counting • Periodic counting | | |
| Degree of protection to EN 60529 | IP65, IP67 | | |
| Temperature range | Operation [°C] | -5 ... +50 | |
| | Storage/transport [°C] | -20 ... +70 | |
| Certification | UL – Recognized (OL) | | |
| Information on materials: Housing | Plastic | | |
| Note on materials | RoHS-compliant | | |
| PWIS conformity | VDMA24364-B2-L | | |
| Grid dimension | [mm] | 50 | |
| Dimensions (including interlinking block and connection block) W x L x H | [mm] | 50 x 107 x 50 | |
| Product weight | [g] | 130 | |

Data sheet – Counter module, digital

Connection and display components

CPX-2ZE2DA

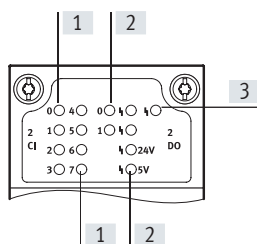

- [1] Status LEDs (green): for allocation to the inputs → pin allocation of the module
- [2] Status LEDs (yellow, red): for allocation to the inputs a pin allocation of the module
- [3] Error LED (red) (module error)

Pin allocation

Inputs/outputs



CPX-2ZE2DA

| Inputs/outputs | | CPX-2ZE2DA | |
|--|--|------------------------------------|------------------------------------|
| | | Channel 0 | Channel 1 |
| X1 .0 .1 .2 .3 X2 .0 .1 .2 .3 X3 .0 .1 .2 .3 X4 .0 .1 .2 .3 | X5 .0 .1 .2 .3 X6 .0 .1 .2 .3 X7 .0 .1 .2 .3 X8 .0 .1 .2 .3 | X1.0: Input | X5.0: Input |
| | | X1.1: Input | X5.1: Input |
| | | X1.2: Input | X5.2: Input |
| | | X1.3: Input | X5.3: Input |
| | | X2.0: Input | X6.0: Input |
| | | X2.1: Input | X6.1: Input |
| | | X2.2: 5 V DC | X6.2: 5 V DC |
| | | X2.3: 0 V | X6.3: 0 V |
| | | X3.0: 24 V DC | X7.0: 24 V DC |
| | | X3.1: 0 V | X7.1: 0 V |
| | | X3.2: 24 V DC for digital input DI | X7.2: 24 V DC for digital input DI |
| | | X3.3: Digital input DI | X7.3: Digital input DI |
| X4.0: 0 V for digital input DI | X8.0: 0 V for digital input DI | | |
| X4.1: Digital output DO | X8.1: Digital output DO | | |
| X4.2: Reference potential for DO | X8.2: Reference potential for DO | | |
| X4.3: FE | X8.3: FE | | |

 Note

The allocation and designation of inputs differs fundamentally depending on which type of encoder is connected. Appropriate allocation diagrams can be found in the user documentation for the counter module.

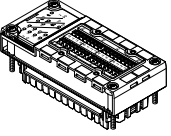
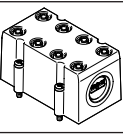
Data sheet – Counter module, digital

| Ordering data | | Part no. | Type |
|--|--|----------|----------------------------|
| Designation | | | |
| Counter module, digital | | | |
|  | 2 digital inputs, 2 digital outputs | 576046 | CPX-2ZE2DA |
| Cover | | | |
|  | Cover for CPX-2ZE2DA (IP65, IP67) • 8 cable through feeds M9 • 1 cable through feed for multi-pin plug | 538219 | AK-8KL |
| | Fittings kit | 538220 | VG-K-M9 |
| User documentation | | | |
|  | User documentation for counter module CPX-2ZE2DA | German | 8035733 P.BE-CPX-2ZE2DA-DE |
| | | English | 8035734 P.BE-CPX-2ZE2DA-EN |
| | | Spanish | 8035735 P.BE-CPX-2ZE2DA-ES |
| | | French | 8035736 P.BE-CPX-2ZE2DA-FR |
| | | Italian | 8035737 P.BE-CPX-2ZE2DA-IT |
| | | Chinese | 8035738 P.BE-CPX-2ZE2DA-ZH |

Data sheet – HART input/output module

Function

The HART input/output module allows the connection of up to 4 sensors or actuators. The corresponding communication channel is made available for sensors or actuators that communicate using the HART protocol.

With the HART protocol, a conventional analogue 4 ... 20 mA current signal is modulated by a second frequency-modulated signal.

Each of the 4 connections of the module can be configured as inputs or outputs.

Area of application

- Multi I/O module for 24 V DC supply voltage
- Supports connection blocks with M12 and terminal connection
- Module features can be parameterised
- The module receives the voltage supply for the electronics, outputs and the sensors from the interlinking block
- Module protection and diagnostics through integrated electronic protection

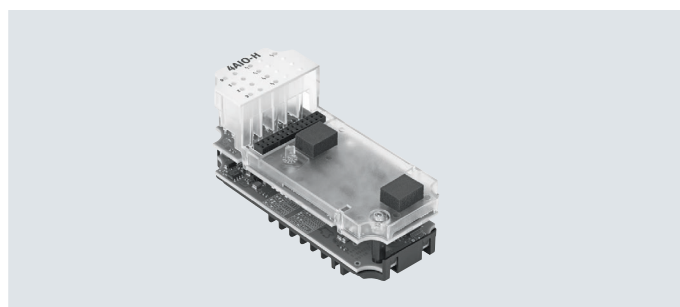

| General technical data | | CPX-4AE-4AA-H | | |
|--|------------------------|--|---------------|-----------------------|
| Type | | CPX-4AE-4AA-H | | |
| Protocol | | HART | | |
| Number of selectable analogue inputs/outputs | | 4 | | |
| Type of sensor | | 0 ... 20 mA | 4 ... 20 mA | 4 ... 20 mA with HART |
| Operating voltage | Nominal value | [V DC] | 24 | |
| | Permissible range | [V DC] | 18 ... 30 | |
| Power failure buffering | | [ms] | 10 | |
| Intrinsic current consumption at nominal operating voltage | | [mA] | Typically 170 | |
| Maximum short circuit current | | [mA] | 22 | |
| Maximum open circuit voltage | | [V] | 28.8 | |
| Minimum available sensor voltage | | 20.7 V DC at 20 mA | | |
| Fuse protection (short circuit) | | Internal electronic fuse per channel | | |
| Reverse polarity protection | | For all electrical connections | | |
| Galvanic isolation | Channel – channel | No | | |
| | Channel – internal bus | Yes | | |
| Signal range | | 0 ... 20 mA | 4 ... 20 mA | 4 ... 20 mA with HART |
| Data format | | 15 bits + prefix | | |
| | | Scalable to 15 bits | | |
| Maximum load | | [Ω] | 750 | |
| Maximum input resistance | | [Ω] | 300 | |
| Maximum cable length | | [m] | 500 | |
| Basic error limit at 25°C | | [%] | ±0.1 | |
| Operating error limit related to the ambient temperature range | | [%] | ±0.3 | |
| Repetition accuracy | | 0.05% at 20°C | | |
| LED displays | Group diagnostics | 1 | | |
| | Channel diagnostics | 4 | | |
| | Channel status | 4 | | |
| Control elements | | DIL switch | | |
| Diagnostics | | <ul style="list-style-type: none"> • Wire break per channel • Limit value violation per channel • Short circuit/overload per channel • Parameterisation error • Overflow/underflow • Limit value violation to NE43 per channel | | |

Data sheet – HART input/output module

| General technical data | |
|----------------------------------|--|
| Parameterisation | <ul style="list-style-type: none"> • Data format • Failsafe per channel • Forcing per channel • Limit value monitoring per channel • Idle mode per channel • Measured value smoothing • Signal range per channel • Monitoring overflow/underflow • Monitoring to NE43, inputs • Monitoring of wire break per channel • Wire break per channel • Limit value violation per channel • Short circuit/overload per channel • Parameterisation error • Overflow/underflow • Limit value violation to NE43 per channel • Number of HART repetitions • Hysteresis for limit values • HART variables (4 pieces) • Behaviour after short circuit/overload |
| Degree of protection to EN 60529 | Depending on connection block |

| Technical data – Mechanical components | |
|---|-----------------------|
| Type of mounting | On interlinking block |
| Product weight | [g] 77.4 |
| Grid dimension | [mm] 50 |
| Dimensions (including interlinking block and connection block) W x L x H | [mm] 50 x 107 x 70 |

| Materials | |
|-------------------|-------------------|
| Housing | Reinforced PA, PC |
| Note on materials | RoHS-compliant |
| PWIS conformity | VDMA24364-B2-L |

| Operating and environmental conditions | |
|--|-----------------------------------|
| Ambient temperature | [°C] -5 ... +50 |
| Storage temperature | [°C] -20 ... +70 |
| Relative humidity | [%] 95, non-condensing |
| Corrosion resistance class CRC ¹⁾ | 1 (when installed) |
| CE marking (see declaration of conformity) ³⁾ | To EU EMC Directive ²⁾ |

1) Additional information: www.festo.com/x/topic/kbk

2) For information about the area of use, see the EC declaration of conformity at: www.festo.com/catalogue/... → Support/Downloads.

If the devices are subject to usage restrictions in residential, commercial or light-industrial environments, further measures for the reduction of the emitted interference may be necessary.

3) Additional information: www.festo.com/catalogue/... → Support/Downloads.

| Safety characteristics | |
|------------------------|--|
| Shock resistance | Shock test with severity level 2 to FN 942017-5 and EN 60068-2-27 |
| Vibration resistance | Transport application test with severity level 2 to FN 942017-4 and EN 60068-2-6 |

Data sheet – HART input/output module

Connection and display components

CPX-4EA-4AA-H

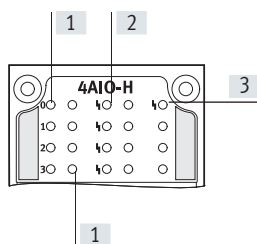

- [1] Status LEDs:
 – Inputs (green)
 – Outputs (yellow)
 → Pin allocation for module
- [2] Error LEDs (red): for allocation to the inputs → pin allocation of the module
- [3] Error LED (red)
 (module error)

Combinations of bus nodes/control blocks with HART input/output module

| Bus node/control block | Part no. | Protocol | Can be combined as of release | HART variables in process image only | Full HART functionality |
|------------------------|----------|-------------------|-------------------------------|--------------------------------------|-------------------------|
| CPX-CEC-C1-V3 | 3473128 | CODESYS Level 2 | 3.5.12.174 | – | ■ |
| CPX-CEC-M1-V3 | 3472765 | CODESYS Level 2 | 3.5.12.174 | – | ■ |
| CPX-CEC-S1-V3 | 3472425 | CODESYS Level 2 | 3.5.12.174 | – | ■ |
| CPX-FB11 | 526172 | DeviceNet | 25 | ■ | – |
| CPX-FB13 | 195740 | PROFIBUS | 34 | – | ■ |
| CPX-FB14 | 526174 | CANopen | 30 | ■ | – |
| CPX-FB36 | 1912451 | EtherNet/IP | 15 | – | ■ |
| CPX-FB37 | 2735960 | EtherCAT | 7 | ■ | – |
| CPX-FB43 | 8110369 | PROFINET RT, M12 | 45 | – | ■ |
| CPX-M-FB44 | 8110370 | PROFINET RT, RJ45 | 45 | – | ■ |
| CPX-M-FB45 | 8110371 | PROFINET RT, SCRJ | 45 | – | ■ |

Combinations of connection blocks with HART input/output module

| Connection blocks | Part no. | HART input/output module |
|---------------------|----------|--------------------------|
| | | CPX-4EA-4AA-H |
| CPX-P-AB-4XM12-4POL | 565706 | ■ |
| CPX-P-AB-2XKL-8POL | 565704 | ■ |

Combinations of connection blocks with interlinking block

| Connection blocks | Part no. | Plastic interlinking block | Metal interlinking block |
|---------------------|----------|----------------------------|--------------------------|
| | | CPX-GE... | CPX-M-GE... |
| CPX-P-AB-4XM12-4POL | 565706 | – | ■ |
| CPX-P-AB-2XKL-8POL | 565704 | ■ | ■ |





Data sheet – HART input/output module

| Pin allocation | | CPX-4AE-4AA-H | | | |
|---------------------------------|--|--|--|--|--|
| Connection block inputs/outputs | | Inputs | | Outputs | |
| CPX-P-AB-4XM12-4POL | | | | | |
| | | X1.1: $24 V_{SEN\ x}$ X1.2: 0 V X1.3: Input x X1.4: 0 V X2.1: $24 V_{SEN\ x+1}$ X2.2: 0 V X2.3: Input x+1 X2.4: 0 V | X3.1: $24 V_{SEN\ x+2}$ X3.2: 0 V X3.3: Input x+2 X3.4: 0 V X4.1: $24 V_{SEN\ x+3}$ X4.2: 0 V X4.3: Input x+3 X4.4: 0 V | X1.1: Output I0+ X1.2: 0 V X1.3: – X1.4: 0 V X2.1: Output I1+ X2.2: 0 V X2.3: – X2.4: 0 V | X3.1: Output I2+ X3.2: 0 V X3.3: – X3.4: 0 V X4.1: Output I3+ X4.2: 0 V X4.3: – X4.4: 0 V |
| CPX-P-AB-2XKL-8POL | | | | | |
| | | X1.1: $24 V_{SEN\ x}$ X1.2: 0 V X1.3: Input x X1.4: 0 V X1.5: $24 V_{SEN\ x+1}$ X1.6: 0 V X1.7: Input x+1 X1.8: 0 V | X2.1: $24 V_{SEN\ x+2}$ X2.2: 0 V X2.3: Input x+2 X2.4: 0 V X2.5: $24 V_{SEN\ x+3}$ X2.6: 0 V X2.7: Input x+3 X2.8: 0 V | X1.1: Output I0+ X1.2: 0 V X1.3: – X1.4: 0 V X1.5: Output I1+ X1.6: 0 V X1.7: – X1.8: 0 V | X2.1: Output I2+ X2.2: 0 V X2.3: – X2.4: 0 V X2.5: Output I3+ X2.6: 0 V X2.7: – X2.8: 0 V |

Note

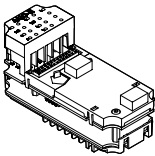
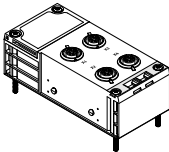
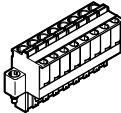
In the case of mixed operation of inputs and outputs in one module, the connections are first assigned input signals and then output signals, in ascending order.

Data sheet – HART input/output module

| Ordering data | | | | Part no. | Type |
|---|--|------------------------|---|----------------|----------------------------|
| Designation | | | | | |
| HART input/output module | | | | | |
|  | 4 analogue inputs/outputs | | | 8059847 | CPX-4AE-4AA-H |
| Connection block | | | | | |
|  | Plastic | 4x socket, M12, 4-pin | | 565706 | CPX-P-AB-4XM12-4POL |
| | | 2x plug, 8-pin | | 565704 | CPX-P-AB-2XKL-8POL |
| Plug | | | | | |
|  | 8-pin socket | Spring-loaded terminal | Connection cross section 0.2 ... 2.5 mm ² | 565712 | NECU-L3G8-C1 |
| | | Screw terminal | Connection cross section 0.2 ... 2.5 mm ² | 565710 | NECU-L3G8-C2 |
|  | Plug M12x1, 4-pin, straight, A-coded | Screw terminal | Connection cross section 0.14 ... 0.5 mm ² | 192008 | SEA-4GS-7-2.5 |
| | | | Nominal conductor cross section 14 ... 0.75 mm ² | 18666 | SEA-GS-7 |
| | | | Permissible cable \varnothing 4 ... 6 mm | | |
| | | | Connection cross section 0.75 mm ² | 18778 | SEA-GS-9 |
| | | | Permissible cable \varnothing 6 ... 8 mm | | |
| Cover | | | | | |
|  | Cover cap for sealing unused connections M12x1 (10 pieces) | | | 165592 | ISK-M12 |
| Coding element | | | | | |
|  | To ensure that a coded socket NECU-L3G8 can only be inserted in the matching coded connection block CPX-P-AB-2XKL (96 of each) | | For NECU-L3G8 | 565713 | CPX-P-KDS-AB-2XKL |

Data sheet – Input module, analogue

Function

Analogue modules control devices with a standardised analogue interface such as pressure switches, temperature, flow rate, filling level, etc.

Depending on the connection block selected, the analogue module supports various connection concepts with different numbers of sockets or terminals.

Area of application

- Analogue module for 0 ... 10 V, 0 ... 20 mA or 4 ... 20 mA
- Supports connection blocks with Sub-D, terminal connection and M12 connection
- Analogue module features can be parameterised
- Different data formats available
- Operation with and without galvanic isolation possible
- The analogue module receives the voltage supply for the electronics and the sensors from the interlinking block
- Analogue module protection and diagnostics through integrated electronic fuse protection

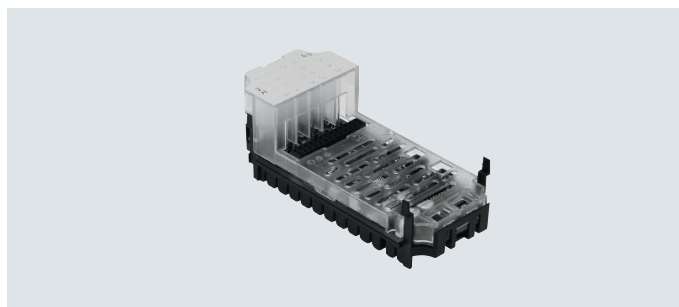

| General technical data | | CPX-2AE-U-I | | CPX-4AE-U-I | | CPX-4AE-I |
|---|--------|---|----------------------------|---|--|---|
| | | Voltage input | Current input | Voltage input | Current input | Current input |
| Type | | | | | | |
| Number of analogue inputs | | 2 | | 4 | | 4 |
| Max. power supply per module | [A] | 0.7 | | | | |
| Fuse protection | | Internal electronic fuse | | | | |
| Current consumption from 24 V sensor supply (quiescent current) | [mA] | Typically 50 | | | | |
| Current consumption from 24 V sensor supply (at full load) | [A] | Max. 0.7 | | | | |
| Nominal operating voltage for load voltage | [V DC] | 24 ±2% | | | | |
| Nominal operating voltage | [V DC] | 24 | | | | |
| Operating voltage range | [V DC] | 18 ... 30 | | | | |
| Signal range (parameterisable for each channel with DIL switch or software) | | 0 ... 10 V | 0 ... 20 mA 4 ... 20 mA | 1 ... 5 V 0 ... 10 V -5 ... +5 V -10 ... +10 V | 0 ... 20 mA 4 ... 20 mA -20 ... +20 mA | 0 ... 20 mA 4 ... 20 mA |
| Operational error limit | [%] | ±0.5 | – | ±0.3 | ±0.3 | ±0.6 |
| Basic error limit (at 25°C) | [%] | ±0.3 | – | ±0.2 | ±0.2 | ±0.5 |
| Repetition accuracy (at 25°C) | [%] | 0.15 | 0.15 | 0.1 | 0.1 | 0.15 |
| Input resistance | | 100 kΩ | ≤ 100 Ω | 100 kΩ | ≤ 100 Ω | ≤ 100 Ω |
| Max. permissible input voltage | [V DC] | 30 | – | -30 ... +30 | – | – |
| Max. permissible input current | [mA] | – | 40 | – | Internally limited to 60 | 40 |
| Conversion time per channel | [μs] | Typically 150 | | | | |
| Cycle time (module) | [ms] | ≤ 4 | | ≤ 0.5 | | ≤ 10 |
| Data format | | 12 bits + prefix Scalable to 15 bits | | 15 bits + prefix Scalable to 15 bits | | 12 bits + prefix Scalable to 15 bits |
| Cable length | [m] | Max. 30 (shielded) | | | | |

Data sheet – Input module, analogue

| General technical data | | CPX-2AE-U-I | CPX-4AE-U-I | CPX-4AE-I | |
|--|--------------------------------------|---|-----------------------------|---|----|
| Galvanic isolation | Channel – channel | No | | | |
| | Channel – internal bus | Yes, with external sensor supply | | | |
| LED displays | Group diagnostics | 1 | | | |
| | Channel diagnostics | Via flashing frequency of group diagnostics | 4 | Via flashing frequency of group diagnostics | |
| Diagnostics | Wire break per channel | | | | |
| | Limit value violation per channel | | | | |
| | Parameterisation error | | | | |
| | Short circuit, input signal | Overload at input | Short circuit, input signal | | |
| | – | Overflow/underflow | – | | |
| | – | Short circuit in sensor supply | – | | |
| Parameterisation | Data format | | | | |
| | Forcing per channel | | | | |
| | Limit value monitoring per channel | | | | |
| | Measured value smoothing | | | | |
| | Signal range per channel | | | | |
| | Monitoring of wire break per channel | | | | |
| | Behaviour after short circuit | | | | |
| | – | Behaviour after overload at input | – | | |
| | – | Sensor supply active | – | | |
| | Degree of protection to EN 60529 | | | | |
| Depending on connection block | | | | | |
| Temperature range | Operation | [°C] | –5 ... +50 | | |
| | Storage/transport | [°C] | –20 ... +70 | | |
| Materials | | Reinforced PA, PC | | | |
| Note on materials | | – | RoHS-compliant | – | |
| PWIS conformity | | VDMA24364-B2-L | VDMA24364-B2-L | VDMA24364-B2-L | |
| Grid dimension | | [mm] | 50 | | |
| Dimensions (including interlinking block and connection block) W x L x H | | [mm] | 50 x 107 x 50 | | |
| Product weight | | [g] | 48 | 46 | 47 |

Data sheet – Input module, analogue

Connection and display components

CPX-2AE-U-I and CPX-4AE-I

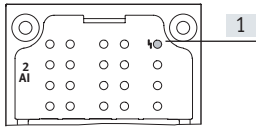

[1] Error LED (red; module error)

CPX-4AE-U-I

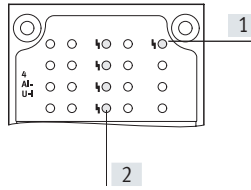

[1] Error LED (red; module error)
[2] Channel-related error LEDs (red)

Combinations of connection blocks and analogue module

| Connection blocks | Part no. | Analogue module | | |
|-----------------------|----------|-----------------|-------------|-----------|
| | | CPX-2AE-U-I | CPX-4AE-U-I | CPX-4AE-I |
| CPX-AB-4-M12X2-5POL | 195704 | ■ | ■ | ■ |
| CPX-AB-4-M12X2-5POL-R | 541254 | ■ | ■ | ■ |
| CPX-AB-8-KL-4POL | 195708 | ■ | ■ | ■ |
| CPX-AB-1-SUB-BU-25POL | 525676 | ■ | ■ | ■ |
| CPX-M-AB-4-M12X2-5POL | 549367 | ■ | ■ | ■ |

Pin allocation

| Connection block inputs | CPX-2AE-U-I | CPX-4AE-U-I | CPX-4AE-I |
|-------------------------|-------------|-------------|-----------|
|-------------------------|-------------|-------------|-----------|

CPX-AB-4-M12X2-5POL, CPX-AB-4-M12X2-5POL-R¹⁾ and CPX-M-AB-4-M12X2-5POL

| | | | | | | |
|--|---------------------------|---------------------------|---------------------------|---------------------------|---------------------------|---------------------------|
| | X1.1: 24 V _{SEN} | X3.1: 24 V _{SEN} | X1.1: 24 V _{SEN} | X3.1: 24 V _{SEN} | X1.1: 24 V _{SEN} | X3.1: 24 V _{SEN} |
| | X1.2: Input U0+ | X3.2: Input U1+ | X1.2: Input 0+ | X3.2: Input 2+ | X1.2: Input I0+ | X3.2: Input I2+ |
| | X1.3: 0 V _{SEN} | X3.3: 0 V _{SEN} | X1.3: 0 V _{SEN} | X3.3: 0 V _{SEN} | X1.3: 0 V _{SEN} | X3.3: 0 V _{SEN} |
| | X1.4: Input U0- | X3.4: Input U1- | X1.4: Input 0- | X3.4: Input 2- | X1.4: Input I0- | X3.4: Input I2- |
| | X1.5: FE ²⁾ | X3.5: FE ²⁾ | X1.5: FE ²⁾ | X3.5: FE ²⁾ | X1.5: FE ²⁾ | X3.5: FE ²⁾ |
| | X2.1: 24 V _{SEN} | X4.1: 24 V _{SEN} | X2.1: 24 V _{SEN} | X4.1: 24 V _{SEN} | X2.1: 24 V _{SEN} | X4.1: 24 V _{SEN} |
| | X2.2: Input I0+ | X4.2: Input I1+ | X2.2: Input 1+ | X4.2: Input 3+ | X2.2: Input I1+ | X4.2: Input I3+ |
| | X2.3: 0 V _{SEN} | X4.3: 0 V _{SEN} | X2.3: 0 V _{SEN} | X4.3: 0 V _{SEN} | X2.3: 0 V _{SEN} | X4.3: 0 V _{SEN} |
| | X2.4: Input I0- | X4.4: Input I1- | X2.4: Input 1- | X4.4: Input 3- | X2.4: Input I1- | X4.4: Input I3- |
| | X2.5: FE ²⁾ | X4.5: FE ²⁾ | X2.5: FE ²⁾ | X4.5: FE ²⁾ | X2.5: FE ²⁾ | X4.5: FE ²⁾ |

CPX-AB-8-KL-4POL

| | | | | | | |
|--|---------------------------|---------------------------|---------------------------|---------------------------|---------------------------|---------------------------|
| | X1.0: 24 V _{SEN} | X5.0: 24 V _{SEN} | X1.0: 24 V _{SEN} | X5.0: 24 V _{SEN} | X1.0: 24 V _{SEN} | X5.0: 24 V _{SEN} |
| | X1.1: 0 V _{SEN} | X5.1: 0 V _{SEN} | X1.1: 0 V _{SEN} | X5.1: 0 V _{SEN} | X1.1: 0 V _{SEN} | X5.1: 0 V _{SEN} |
| | X1.2: Input U0- | X5.2: Input U1- | X1.2: Input 0- | X5.2: Input 2- | X1.2: Input I0- | X5.2: Input I2- |
| | X1.3: FE | X5.3: FE | X1.3: FE | X5.3: FE | X1.3: FE | X5.3: FE |
| | X2.0: n.c. | X6.0: n.c. | X2.0: n.c. | X6.0: n.c. | X2.0: n.c. | X6.0: n.c. |
| | X2.1: n.c. | X6.1: n.c. | X2.1: n.c. | X6.1: n.c. | X2.1: n.c. | X6.1: n.c. |
| | X2.2: Input U0+ | X6.2: Input U1+ | X2.2: Input 0+ | X6.2: Input 2+ | X2.2: Input I0+ | X6.2: Input I2+ |
| | X2.3: FE | X6.3: FE | X2.3: FE | X6.3: FE | X2.3: FE | X6.3: FE |
| | X3.0: 24 V _{SEN} | X7.0: 24 V _{SEN} | X3.0: 24 V _{SEN} | X7.0: 24 V _{SEN} | X3.0: 24 V _{SEN} | X7.0: 24 V _{SEN} |
| | X3.1: 0 V _{SEN} | X7.1: 0 V _{SEN} | X3.1: 0 V _{SEN} | X7.1: 0 V _{SEN} | X3.1: 0 V _{SEN} | X7.1: 0 V _{SEN} |
| | X3.2: Input I0- | X7.2: Input I1- | X3.2: Input 1- | X7.2: Input 3- | X3.2: Input I1- | X7.2: Input I3- |
| | X3.3: FE | X7.3: FE | X3.3: FE | X7.3: FE | X3.3: FE | X7.3: FE |
| | X4.0: n.c. | X8.0: n.c. | X4.0: n.c. | X8.0: n.c. | X4.0: n.c. | X8.0: n.c. |
| | X4.1: n.c. | X8.1: n.c. | X4.1: n.c. | X8.1: n.c. | X4.1: n.c. | X8.1: n.c. |
| | X4.2: Input I0+ | X8.2: Input I1+ | X4.2: Input 1+ | X8.2: Input 3+ | X4.2: Input I1+ | X8.2: Input I3+ |
| | X4.3: FE | X8.3: FE | X4.3: FE | X8.3: FE | X4.3: FE | X8.3: FE |

1) Speedcon quick lock, additional shielding on metal thread



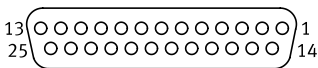

2) FE/shield additionally on metal thread

Data sheet – Input module, analogue

| Pin allocation | | CPX-2AE-U-I | | CPX-4AE-U-I | | CPX-4AE-I | |
|---|--|-----------------------------|-------------------------|-----------------------------|-------------------------|-----------------------------|-------------------------|
| Connection block inputs | | CPX-2AE-U-I | | CPX-4AE-U-I | | CPX-4AE-I | |
| CPX-AB-1-SUB-BU-25POL | | | | | | | |
|  | | 1: Input U0- | 14: Input U1- | 1: Input 0- | 14: Input 2- | 1: Input I0- | 14: Input I2- |
| | | 2: Input U0+ | 15: Input U1+ | 2: Input 0+ | 15: Input 2+ | 2: Input I0+ | 15: Input I2+ |
| | | 3: Input I0- | 16: Input I1- | 3: Input 1- | 16: Input 3- | 3: Input I1- | 16: Input I3- |
| | | 4: Input I1+ | 17: Input I1+ | 4: Input 1+ | 17: Input 3+ | 4: Input I1+ | 17: Input I3+ |
| | | 5: n.c. | 18: 24 V _{SEN} | 5: n.c. | 18: 24 V _{SEN} | 5: n.c. | 18: 24 V _{SEN} |
| | | 6: n.c. | 19: n.c. | 6: n.c. | 19: n.c. | 6: n.c. | 19: n.c. |
| | | 7: n.c. | 20: 24 V _{SEN} | 7: n.c. | 20: 24 V _{SEN} | 7: n.c. | 20: 24 V _{SEN} |
| | | 8: n.c. | 21: n.c. | 8: n.c. | 21: n.c. | 8: n.c. | 21: n.c. |
| | | 9: 24 V _{SEN} | 22: 0 V _{SEN} | 9: 24 V _{SEN} | 22: 0 V _{SEN} | 9: 24 V _{SEN} | 22: 0 V _{SEN} |
| | | 10: 24 V _{SEN} | 23: 0 V _{SEN} | 10: 24 V _{SEN} | 23: 0 V _{SEN} | 10: 24 V _{SEN} | 23: 0 V _{SEN} |
| | | 11: 0 V _{SEN} | 24: 0 V _{SEN} | 11: 0 V _{SEN} | 24: 0 V _{SEN} | 11: 0 V _{SEN} | 24: 0 V _{SEN} |
| | | 12: 0 V _{SEN} | 25: FE | 12: 0 V _{SEN} | 25: FE | 12: 0 V _{SEN} | 25: FE |
| | | 13: Shielding ¹⁾ | Housing: FE | 13: Shielding ¹⁾ | Housing: FE | 13: Shielding ¹⁾ | Housing: FE |

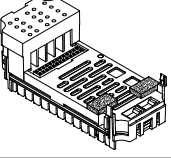
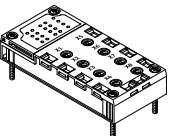
1) Connect shield to functional earth FE

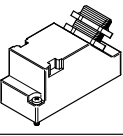
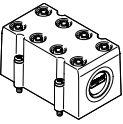
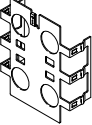
Data sheet – Input module, analogue

| Ordering data | | Part no. | Type | |
|--|--|--|-----------------|-----------------------|
| Input module, analogue | | | | |
|  | 2 analogue current or voltage inputs | 526168 | CPX-2AE-U-I | |
| | 4 analogue current or voltage inputs | 573710 | CPX-4AE-U-I | |
| | 4 analogue current inputs | 541484 | CPX-4AE-I | |
| Connection block | | | | |
|  | Plastic | 4x socket M12, 5-pin | 195704 | CPX-AB-4-M12X2-5POL |
| | | 4x socket, M12 with quick-lock technology, 5-pin | 541254 | CPX-AB-4-M12X2-5POL-R |
| | | Spring-loaded terminal, 32-pin | 195708 | CPX-AB-8-KL-4POL |
| | | 1x socket, Sub-D, 25-pin | 525676 | CPX-AB-1-SUB-BU-25POL |
| | Metal | 4x socket M12, 5-pin | 549367 | CPX-M-AB-4-M12X2-5POL |
| Plug | | | | |
|  | Plug M12, 5-pin | 175487 | SEA-M12-5GS-PG7 | |
|  | Sub-D plug, 25-pin | 527522 | SD-SUB-D-ST25 | |
| Cover | | | | |
|  | Cover for CPX-AB-8-KL-4POL (IP65, IP67) | 538219 | AK-8KL | |
| | <ul style="list-style-type: none"> 8 cable through feeds M9 1 cable through feed for multi-pin plug Fittings kit | 538220 | VG-K-M9 | |
| Screening plate | | | | |
|  | Screening plate for M12 connections | 526184 | CPX-AB-S-4-M12 | |
| User documentation | | | | |
|  | User documentation | German | 526415 | P.BE-CPX-AX-DE |
| | | English | 526416 | P.BE-CPX-AX-EN |
| | | Spanish | 526417 | P.BE-CPX-AX-ES |
| | | French | 526418 | P.BE-CPX-AX-FR |
| | | Italian | 526419 | P.BE-CPX-AX-IT |

Data sheet – Input module, analogue, with pressure sensors

Function

The pressure input modules make it possible to process a maximum of 4 pressures. The internal measured value of the sensor (analogue value with 10-bit resolution) is converted into an internal numerical format as appropriate to the parameterisation and made available to the bus node as a process image. It is additionally also possible to combine 2 channels in each case to form a differential pressure channel.

Area of application

- Measuring range: 0 ... 10 bar or –1 ... +1 bar
- Choice of units of measurement
- Processing a maximum of 4 pressures per module
- Pressure indication via LCD display
- Direct connection via QS4 push-in connectors
- Error message via CPX
- Channel-oriented diagnostics

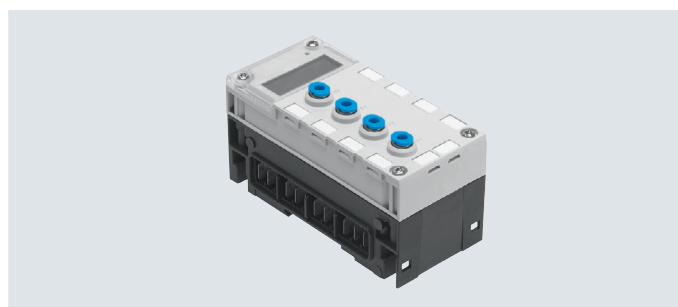

| General technical data | | | CPX-4AE-P-B2 | CPX-4AE-P-D10 |
|---|-------------|-------|---|---------------|
| Type | | | | |
| Number of analogue inputs | | | 4 | |
| Pneumatic connection | | | QS-4 | |
| Nominal operating voltage | [V DC] | | 24 | |
| Operating voltage range | [V DC] | | 18 ... 30 | |
| Intrinsic current consumption | [mA] | | Typically 50 | |
| Measured variable | | | 4 x relative or 2 x differential pressure measurement | |
| Displayable units | | | <ul style="list-style-type: none"> • kPa • mbar • psi | |
| Pressure measuring range | Start value | [bar] | –1 | 0 |
| | Final value | [bar] | 1 | 10 |
| Internal cycle time | [ms] | | 5 | |
| Data format | | | <ul style="list-style-type: none"> • 15 bits + prefix • Binary notation in mbar, kPa, psi | |
| LED displays | | | Group diagnostics | |
| Diagnostics | | | <ul style="list-style-type: none"> • Limit value violation per channel • Parameterisation error • Sensor limit per channel | |
| Parameterisation | | | <ul style="list-style-type: none"> • Diagnostic delay per channel • Hysteresis per module • Unit of measurement • Measured value smoothing per channel • Limit value monitoring per channel • Sensor limit per channel • Measurement of relative/differential pressure | |
| Degree of protection to EN 60529 | | | IP65, IP67 | |
| Operating medium | | | Compressed air to ISO 8573-1:2010 [7:4:4] | |
| Note on the operating/pilot medium | | | Lubricated operation possible (in which case lubricated operation will always be required) | |
| Ambient temperature | [°C] | | –5 ... 50 | |
| Storage temperature | [°C] | | –20 ... 70 | |
| Temperature of medium | [°C] | | 0 ... 50 | |
| Note on materials | | | RoHS-compliant | |
| Materials | | | Reinforced PA, PC | |
| PWIS conformity | | | VDMA24364-B2-L | |
| Grid dimension | [mm] | | 50 | |
| Dimensions (including interlinking block) W x L x H | [mm] | | 50 x 107 x 55 | |
| Product weight | [g] | | 115 | |

 **Note**

Extreme pneumatic conditions, e.g. high cycle rate with high pressure amplitudes, can damage the sensors.

Data sheet – Input module, analogue, with pressure sensors

Connection and display components

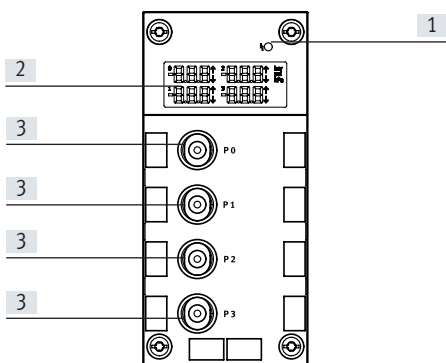

- [1] Error LED (red; module error)
- [2] LCD display with permanent display of the four measured pressures, unit of measurement and if applicable limit value violation
- [3] QS connections

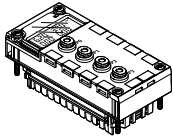
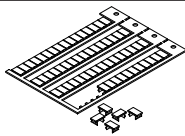
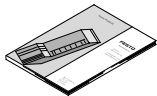
| Ordering data | | Part no. | Type |
|--|--|----------|-----------------------|
| Designation | | | |
| Input module, analogue | | | |
|  | 4 analogue pressure inputs, pressure range -1 ... +1 bar | 560361 | CPX-4AE-P-B2 |
| | 4 analogue pressure inputs, pressure range 0 ... 10 bar | 560362 | CPX-4AE-P-D10 |
| Inscription labels | | | |
|  | Inscription labels 6x10 mm, 64 pieces, in frame | 18576 | IBS-6x10 |
| User documentation | | | |
|  | User documentation | German | 526415 P.BE-CPX-AX-DE |
| | | English | 526416 P.BE-CPX-AX-EN |
| | | Spanish | 526417 P.BE-CPX-AX-ES |
| | | French | 526418 P.BE-CPX-AX-FR |
| | | Italian | 526419 P.BE-CPX-AX-IT |

Data sheet – Input module, analogue, for temperature inputs

Function

The CPX-PT100 analogue input module with 4 channels for temperature measurement enables the connection of up to 4 temperature sensors of the type PT100-PT1000, Ni100-Ni1000, etc. The temperature module supports various connection concepts with different numbers of sockets or terminals as appropriate to the connection block selected.

Area of application

- Temperature module for temperature sensors PT100, PT200, PT500, PT1000, Ni100, Ni120, Ni500, Ni1000
- Supports connection blocks with M12 and terminal connection
- Temperature module features can be parameterised
- 2-wire, 3-wire and 4-wire connection
- The temperature module is provided with voltage supply for the electronics and the sensors via the interlinking block
- Temperature module protection and diagnostics through integrated electronic fuse protection

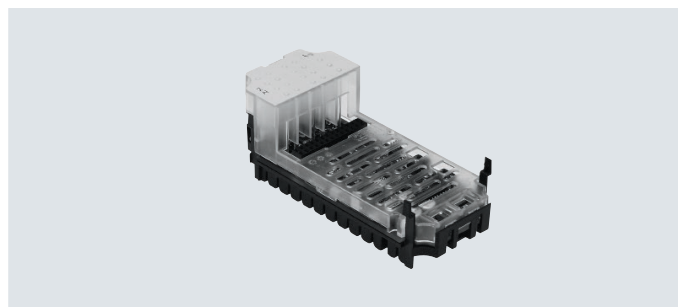

| General technical data | | | CPX-4AE-T |
|---|-------------|------|--|
| Type | | | Temperature input |
| Number of analogue inputs | | | Choice of 2 or 4 |
| Max. power supply per module | [A] | | 0.7 |
| Fuse protection | | | Internal electronic fuse for sensor supply |
| Current consumption from 24 V sensor supply (quiescent current) | [mA] | | Typically 50 |
| Sensor supply voltage | [V DC] | | 24 ±25% |
| Sensor type (parameterisable for each channel with DIL switch) | | | PT100, PT200, PT500, PT1000 Ni100, Ni120, Ni500, Ni1000 |
| Temperature range | Pt standard | [°C] | -200 ... +850 |
| | Pt climatic | [°C] | -120 ... +130 |
| | Ni | [°C] | -60 ... +180 |
| Sensor connection technology | | | 2-wire, 3-wire and 4-wire technology |
| Resolution | | | 15 bits + prefix |
| Operating error limit relative to input range | [%] | | ±0.06 |
| Basic error limit (25°C) | Standard | [K] | ±0.6 |
| | Pt climatic | [K] | ±0.2 |
| Temperature errors relative to input range | [%] | | ±0.001 |
| Linearity errors (no software scaling) | [%] | | ±0.02 |
| Repetition accuracy (at 25°C) | [%] | | ±0.05 |
| Max. line resistance per conductor | [Ω] | | 10 |
| Max. permissible input voltage | [V] | | ±30 |
| Cycle time (module) | [ms] | | ≤ 250 |

Data sheet – Input module, analogue, for temperature inputs

| General technical data | | |
|--|------------------------|---|
| Data format | | 15 bits + prefix, complement of two, binary notation in tenths of a degree |
| Cable length | [m] | Max. 200 (shielded) |
| Galvanic isolation | Channel – channel | No |
| | Channel – internal bus | Yes |
| LED displays | Group diagnostics | 1 |
| | Channel diagnostics | 4 |
| Diagnostics | | <ul style="list-style-type: none"> • Short circuit/overload, channel • Parameterisation error • Value falling below nominal range/full-scale value • Value exceeding nominal range/full-scale value • Wire break |
| Parameterisation | | <ul style="list-style-type: none"> • Unit of measurement and interference frequency suppression • Diagnostic message in the event of a wire break or short circuit • Limit monitoring per channel • Sensor connection technology • Sensor type/temperature coefficient, temperature range • Limit value per channel • Measured value smoothing |
| Degree of protection to EN 60529 | | Depending on connection block |
| Temperature range | Operation | [°C] -5 ... +50 |
| | Storage/transport | [°C] -20 ... +70 |
| Materials | | Reinforced PA, PC |
| PWIS conformity | | VDMA24364-B2-L |
| Grid dimension | [mm] | 50 |
| Dimensions (including interlinking block and connection block) W x L x H | [mm] | 50 x 107 x 50 |
| Product weight | [g] | 47 |

Connection and display components

CPX-4AE-T

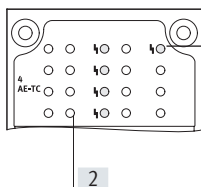

- [1] Error LED (red; module error)
- [2] Channel-related error LEDs (red)

Combinations of connection blocks and analogue module

| Connection blocks | Part no. | Temperature module |
|-----------------------|----------|--------------------|
| | | CPX-4AE-T |
| CPX-AB-4-M12X2-5POL | 195704 | ■ |
| CPX-AB-4-M12X2-5POL-R | 541254 | ■ |
| CPX-AB-8-KL-4POL | 195708 | ■ |
| CPX-M-AB-4-M12X2-5POL | 549367 | ■ |



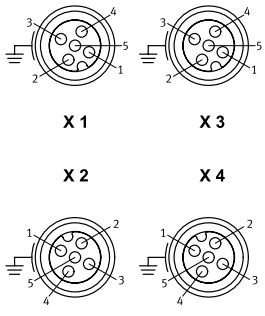
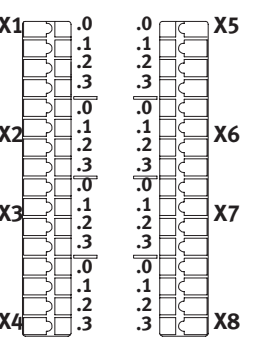

Data sheet – Input module, analogue, for temperature inputs

| Pin allocation | | CPX-4AE-T |
|--|--|---|
| Connection block inputs | | |
| CPX-AB-4-M12X2-5POL, CPX-AB-4-M12X2-5POL-R¹⁾ and CPX-M-AB-4-M12X2-5POL | | |
|  <p>X 1 X 3</p> <p>X 2 X 4</p> | X1.1: Input I0+ X1.2: Input U0+ X1.3: Input I0– X1.4: Input U0– X1.5: FE ²⁾ X2.1: Input I1+ X2.2: Input U1+ X2.3: Input I1– X2.4: Input U1– X2.5: FE ²⁾ | X3.1: Input I2+ X3.2: Input U2+ X3.3: Input I2– X3.4: Input U2– X3.5: FE ²⁾ X4.1: Input I3+ X4.2: Input U3+ X4.3: Input I3– X4.4: Input U3– X4.5: FE ²⁾ |
| CPX-AB-8-KL-4POL | | |
|  <p>X1 .0 .0 X5</p> <p> .1 .1</p> <p> .2 .2</p> <p> .3 .3</p> <p>X2 .0 .0 X6</p> <p> .1 .1</p> <p> .2 .2</p> <p> .3 .3</p> <p>X3 .0 .0 X7</p> <p> .1 .1</p> <p> .2 .2</p> <p> .3 .3</p> <p>X4 .0 .0 X8</p> <p> .1 .1</p> <p> .2 .2</p> <p> .3 .3</p> | X1.0: Input I0+ X1.1: Input I0– X1.2: Input U0– X1.3: FE X2.0: n.c. X2.1: n.c. X2.2: Input U0+ X2.3: FE X3.0: Input I1+ X3.1: Input I1– X3.2: Input U1– X3.3: FE X4.0: n.c. X4.1: n.c. X4.2: Input U1+ X4.3: FE | X5.0: Input I2+ X5.1: Input I2– X5.2: Input U2– X5.3: FE X6.0: n.c. X6.1: n.c. X6.2: Input U12+ X6.3: FE X7.0: Input I3+ X7.1: Input I3– X7.2: Input U3– X7.3: FE X8.0: n.c. X8.1: n.c. X8.2: Input U3+ X8.3: FE |

1) Speedcon quick lock, additional shielding on metal thread

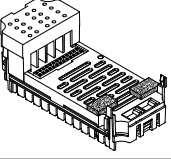
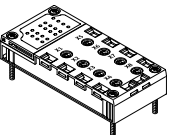
2) FE/shield additionally on metal thread

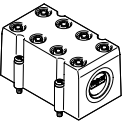
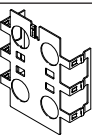
Data sheet – Input module, analogue, for temperature inputs

| Ordering data | | Part no. | Type | |
|--|--|--|-----------------|-----------------------|
| Designation | | | | |
| Input module, analogue | | | | |
|  | 2 or 4 analogue temperature inputs | 541486 | CPX-4AE-T | |
| Connection block | | | | |
|  | Plastic | 4x socket M12, 5-pin | 195704 | CPX-AB-4-M12X2-5POL |
| | | 4x socket, M12 with quick-lock technology, 5-pin | 541254 | CPX-AB-4-M12X2-5POL-R |
| | | Spring-loaded terminal, 32-pin | 195708 | CPX-AB-8-KL-4POL |
| | Metal | 4x socket M12, 5-pin | 549367 | CPX-M-AB-4-M12X2-5POL |
| Plug | | | | |
|  | Plug M12, 5-pin | 175487 | SEA-M12-5GS-PG7 | |
| Cover | | | | |
|  | Cover for CPX-AB-8-KL-4POL (IP65, IP67) | 538219 | AK-8KL | |
| | <ul style="list-style-type: none"> • 8 cable through feeds M9 • 1 cable through feed for multi-pin plug Fittings kit | 538220 | VG-K-M9 | |
| Screening plate | | | | |
|  | Screening plate for M12 connections | 526184 | CPX-AB-S-4-M12 | |
| User documentation | | | | |
|  | User documentation | German | 526415 | P.BE-CPX-AX-DE |
| | | English | 526416 | P.BE-CPX-AX-EN |
| | | Spanish | 526417 | P.BE-CPX-AX-ES |
| | | French | 526418 | P.BE-CPX-AX-FR |
| | | Italian | 526419 | P.BE-CPX-AX-IT |

Data sheet – Input module, analogue, for thermocouple

Function

The CPX-4AE-TC analogue input module with 4 channels for temperature measurement enables up to 4 thermocouple sensors to be connected.

The channels feature wire break and short circuit detection.

If no cold junction compensation sensor is being used, an internal theoretical value of 25°C can be used (accuracy is impaired).

Area of application

- Supports connection blocks with M12 and terminal connection
- Temperature module features can be parameterised
- 2-wire connection
- 2-wire connection for a PT1000 sensor for cold junction compensation
- The temperature module is provided with voltage supply for the electronics and the sensors via the interlinking block
- Temperature module protection and diagnostics through integrated electronic fuse protection

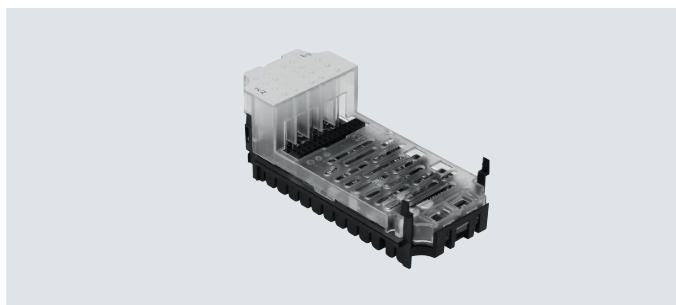

| General technical data | | CPX-4AE-TC |
|--|--------|---|
| Type | | Temperature input |
| Number of analogue inputs | | 4 |
| Fuse protection (short circuit) | | Internal electronic fuse per channel |
| Nominal operating voltage | [V DC] | 24 |
| Operating voltage range | [V DC] | 18 ... 30 |
| Sensor type (parameterisable for each channel with software) | | <ul style="list-style-type: none"> • Type B +400 ... +1820°C, 8 iV/°C • Type E -270 ... +900°C, 60 iV/°C • Type J -200 ... +1200°C, 51 iV/°C • Type K -200 ... +1370°C, 40 iV/°C • Type N -200 ... +1300°C, 38 iV/°C • Type R 0 ... +1760°C, 12 iV/°C • Type S 0 ... +1760°C, 11 iV/°C • Type T -200 ... +400°C, 40 iV/°C |
| Sensor connection technology | | 2-wire technology |
| Operating error limit relative to ambient temperature | [%] | Max. ±0.6 |
| Basic error limit (at 25°C) | [%] | Max. ±0.4 |
| Repetition accuracy (at 25°C) | [%] | ±0.05 |
| Max. line resistance per conductor | [Ω] | 10 |
| Max. residual current per module | [mA] | 30 |
| Max. permissible input voltage | [V] | ±30 |
| Internal cycle time (module) | [ms] | 250 |

Data sheet – Input module, analogue, for thermocouple

| General technical data | | |
|--|------------------------|--|
| Data format | | <ul style="list-style-type: none"> • 15 bits + prefix, complement of two • Binary notation in tenths of a degree |
| Cable length | [m] | Max. 50 (shielded) |
| Galvanic isolation | Channel – channel | No |
| | Channel – internal bus | Yes |
| LED displays | Group diagnostics | 1 |
| | Channel diagnostics | 4 |
| Diagnostics | | <ul style="list-style-type: none"> • Parameterisation error • Wire break per channel • Limit value violation per channel |
| Parameterisation | | <ul style="list-style-type: none"> • Monitoring of wire break per channel • Unit of measurement • Cold-junction compensation • Sensor type per channel • Limit value monitoring per channel • Measured value smoothing |
| Degree of protection to EN 60529 | | Depending on connection block |
| Temperature range | Operation | [°C] –5 ... +50 |
| | Storage/transport | [°C] –20 ... +70 |
| Materials | | Reinforced PA, PC |
| PWIS conformity | | VDMA24364-B2-L |
| Grid dimension | [mm] | 50 |
| Dimensions (including interlinking block and connection block) W x L x H | [mm] | 50 x 107 x 50 |
| Product weight | [g] | 46 |

Connection and display components

CPX-4AE-TC

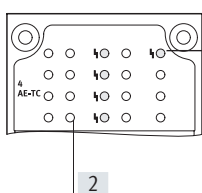

- [1] Error LED (red; module error)
- [2] Channel-related error LEDs (red)

Combinations of connection blocks and analogue module

| Connection blocks | Part no. | Temperature module |
|-----------------------|---------------|--------------------|
| | | CPX-4AE-TC |
| CPX-AB-4-M12X2-5POL | 195704 | ■ |
| CPX-AB-4-M12X2-5POL-R | 541254 | ■ |
| CPX-AB-8-KL-4POL | 195708 | ■ |
| CPX-M-AB-4-M12X2-5POL | 549367 | ■ |

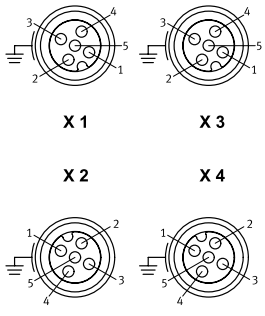
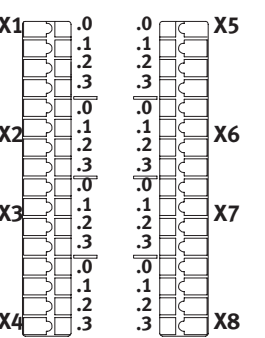

Data sheet – Input module, analogue, for thermocouple

| Pin allocation | | CPX-4AE-TC | |
|--|--|--|--|
| Connection block inputs | | CPX-4AE-TC | |
| CPX-AB-4-M12X2-5POL, CPX-AB-4-M12X2-5POL-R¹⁾ and CPX-M-AB-4-M12X2-5POL | | | |
|  | | X1.1: Cold junction compensation 0+ X1.2: Input signal U0+ X1.3: Cold junction compensation 0- X1.4: Input signal U0- X1.5: FE ²⁾ X2.1: Cold junction compensation 1+ X2.2: Input signal U1+ X2.3: Cold junction compensation 1- X2.4: Input signal U1- X2.5: FE ²⁾ | X3.1: Cold junction compensation 2+ X3.2: Input signal U2+ X3.3: Cold junction compensation 2- X3.4: Input signal U2- X3.5: FE ²⁾ X4.1: Cold junction compensation 3+ X4.2: Input signal U3+ X4.3: Cold junction compensation 3- X4.4: Input signal U3- X4.5: FE ²⁾ |
| CPX-AB-8-KL-4POL | | | |
|  | | X1.0: Cold junction compensation 0+ X1.1: Cold junction compensation 0- X1.2: Input signal U0- X1.3: FE X2.0: n.c. X2.1: n.c. X2.2: Input signal U0+ X2.3: FE X3.0: Cold junction compensation 1+ X3.1: Cold junction compensation 1- X3.2: Input signal U1- X3.3: FE X4.0: n.c. X4.1: n.c. X4.2: Input signal U1+ X4.3: FE | X5.0: Cold junction compensation 2+ X5.1: Cold junction compensation 2- X5.2: Input signal U2- X5.3: FE X6.0: n.c. X6.1: n.c. X6.2: Input signal U2+ X6.3: FE X7.0: Cold junction compensation 3+ X7.1: Cold junction compensation 3- X7.2: Input signal U3- X7.3: FE X8.0: n.c. X8.1: n.c. X8.2: Input signal U3+ X8.3: FE |

1) Speedcon quick lock, additional shielding on metal thread

2) FE/shield additionally on metal thread

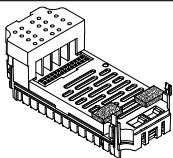
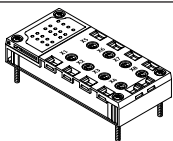
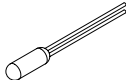
Data sheet – Input module, analogue, for thermocouple

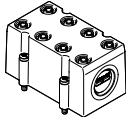
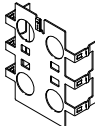
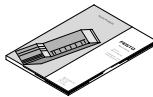
| Ordering data | | Part no. | Type | |
|--|--|--|-----------------|-----------------------|
| Designation | | | | |
| Input module, analogue | | | | |
|  | 4 analogue temperature inputs, with 2-wire connection for a PT1000 sensor for cold junction compensation | 553594 | CPX-4AE-TC | |
| Connection block | | | | |
|  | Plastic | 4x socket M12, 5-pin | 195704 | CPX-AB-4-M12X2-5POL |
| | | 4x socket, M12 with quick-lock technology, 5-pin | 541254 | CPX-AB-4-M12X2-5POL-R |
| | | Spring-loaded terminal, 32-pin | 195708 | CPX-AB-8-KL-4POL |
| | Metal | 4x socket M12, 5-pin | 549367 | CPX-M-AB-4-M12X2-5POL |
| Cold junction compensation | | | | |
|  | PT1000 temperature sensor for cold junction compensation | 553596 | CPX-W-PT1000 | |
| Plug | | | | |
|  | Plug M12, 5-pin | 175487 | SEA-M12-5GS-PG7 | |
| Cover | | | | |
|  | Cover for CPX-AB-8-KL-4POL (IP65, IP67) | 538219 | AK-8KL | |
| | <ul style="list-style-type: none"> • 8 cable through feeds M9 • 1 cable through feed for multi-pin plug Fittings kit | 538220 | VG-K-M9 | |
| Screening plate | | | | |
|  | Screening plate for M12 connections | 526184 | CPX-AB-S-4-M12 | |
| User documentation | | | | |
|  | User documentation | German | 526415 | P.BE-CPX-AX-DE |
| | | English | 526416 | P.BE-CPX-AX-EN |
| | | Spanish | 526417 | P.BE-CPX-AX-ES |
| | | French | 526418 | P.BE-CPX-AX-FR |
| | | Italian | 526419 | P.BE-CPX-AX-IT |

Data sheet – Output module, analogue

Function

Analogue modules control devices with a standard analogue interface such as proportional valves, etc.

Depending on the connection block selected, the analogue module supports various connection concepts with different numbers of sockets or terminals.

Area of application

- Analogue module for 0 ... 10 V, 0 ... 20 mA or 4 ... 20 mA
- Supports connection blocks with Sub-D, terminal connection and M12 connection
- Analogue module features can be parameterised
- Different data formats available
- Operation with and without galvanic isolation possible
- The analogue module receives the voltage supply for the electronics and the actuators from the interlinking block
- Analogue module protection and diagnostics through integrated electronic fuse protection

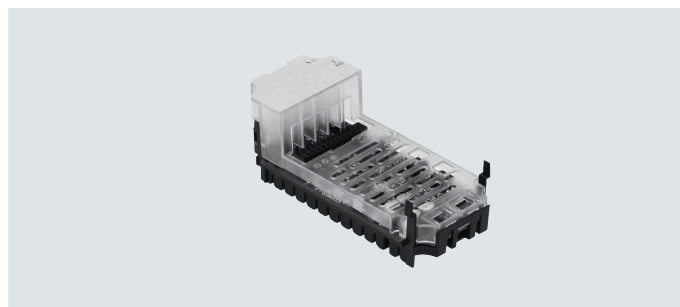

| General technical data | | | | |
|---|--|--|----------------------------|----------|
| Type | | CPX-2AA-U-I | | |
| | | Voltage output | Current output | |
| Number of analogue outputs | | 2 | | |
| Max. actuator supply per module | | [A] | 2.8 | |
| Fuse protection | | Internal electronic fuse for actuator supply | | |
| Current consumption from 24 V sensor supply (at full load) | | [mA] | Max. 150 | |
| Current consumption from 24 V actuator supply (at full load) | | [A] | 4 ... 10 | |
| Supply voltage for actuators | | [V DC] | 24 ±25% | |
| Signal range (parameterisable for each channel with DIL switch or software) | | 0 ... 10 V DC | 0 ... 20 mA 4 ... 20 mA | |
| Resolution | | [bit] | 12 | |
| Number of units | | 4096 | | |
| Absolute accuracy | | [%] | ±0.6 | |
| Linearity errors (no software scaling) | | [%] | ±0.1 | |
| Repetition accuracy (at 25°C) | | [%] | 0.05 | |
| Encoder selection | Load resistance for ohmic load | [kΩ] | Min. 1 | Max. 0.5 |
| | Load resistance for capacitive load | [μF] | Max. 1 | – |
| | Load resistance for inductive load | [mH] | – | Max. 1 |
| | Short circuit protection for analogue output | | Yes | – |
| | Short circuit current of analogue output | [mA] | Approx. 20 | – |
| | Open circuit voltage | [V DC] | – | 18 |
| | Destruction limit against externally applied voltage | [V DC] | 15 | |
| | Actuator connection | | 2 wires | |
| Cycle time (module) | | [ms] | ≤ 4 | |

Data sheet – Output module, analogue

| General technical data | | | CPX-2AA-U-I | |
|--|--|--|----------------|----------------|
| Type | | | Voltage output | Current output |
| Response time | For ohmic load | [ms] | 0.1 | 0.1 |
| | For capacitive load | [ms] | 0.7 | – |
| | For inductive load | [ms] | – | 0.5 |
| Data format | 15 bits + prefix, linear scaling 12 bits right-justified 12 bits left-justified, S7 compatible 12 bits left-justified, S5 compatible | | | |
| Cable length | [m] | Max. 30 (shielded) | | |
| LED displays | Group diagnostics | 1 | | |
| | Channel diagnostics | Yes, via flashing frequency of group diagnostics | | |
| Diagnostics | <ul style="list-style-type: none"> • Short circuit/overload, actuator supply • Parameterisation error • Value falling below nominal range/full-scale value • Value exceeding nominal range/full-scale value • Wire break | | | |
| Parameterisation | <ul style="list-style-type: none"> • Short circuit monitoring, actuator supply • Short circuit monitoring, analogue output • Behaviour after short circuit, actuator supply • Data format • Lower limit value/full-scale value • Upper limit value/full-scale value • Monitoring value falling below nominal range/full-scale value • Monitoring value exceeding nominal range/full-scale value • Monitoring wire break • Signal range | | | |
| Degree of protection to EN 60529 | Depending on connection block | | | |
| Temperature range | Operation | [°C] | –5 ... +50 | |
| | Storage/transport | [°C] | –20 ... +70 | |
| Materials | Reinforced PA, PC | | | |
| PWIS conformity | VDMA24364-B2-L | | | |
| Grid dimension | [mm] | 50 | | |
| Dimensions (including interlinking block and connection block) W x L x H | [mm] | 50 x 107 x 50 | | |
| Product weight | [g] | 49 | | |

Connection and display components

CPX-2AA-U-I

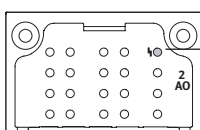

[1] Error LED (red; module error)

Combinations of connection blocks and analogue module

| Connection blocks | Part no. | Analogue module |
|-----------------------|----------|-----------------|
| | | CPX-2AA-U-I |
| CPX-AB-4-M12X2-5POL | 195704 | ■ |
| CPX-AB-4-M12X2-5POL-R | 541254 | ■ |
| CPX-AB-8-KL-4POL | 195708 | ■ |
| CPX-AB-1-SUB-BU-25POL | 525676 | ■ |
| CPX-M-AB-4-M12X2-5POL | 549367 | ■ |

Data sheet – Output module, analogue

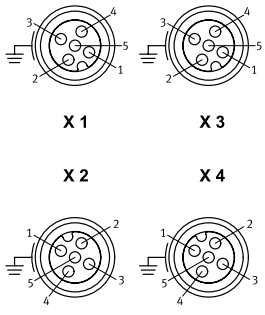
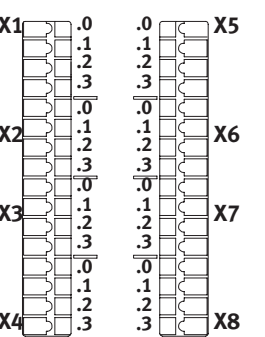
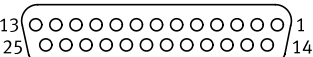



| Pin allocation | | CPX-2AA-U-I |
|--|---|---|
| Connection block outputs | | |
| CPX-AB-4-M12X2-5POL, CPX-AB-4-M12X2-5POL-R¹⁾, CPX-M-AB-4-M12X2-5POL | | |
|  <p>X 1 X 3</p> <p>X 2 X 4</p> | <p>X1.1: 24 V_{OUT}</p> <p>X1.2: Output U0+</p> <p>X1.3: 0 V_{OUT}</p> <p>X1.4: Output GND</p> <p>X1.5: FE²⁾</p> <p>X2.1: 24 V_{OUT}</p> <p>X2.2: Output I0+</p> <p>X2.3: 0 V_{OUT}</p> <p>X2.4: Output GND</p> <p>X2.5: FE²⁾</p> | <p>X3.1: 24 V_{OUT}</p> <p>X3.2: Output U1+</p> <p>X3.3: 0 V_{OUT}</p> <p>X3.4: Output GND</p> <p>X3.5: FE²⁾</p> <p>X4.1: 24 V_{OUT}</p> <p>X4.2: Output I1+</p> <p>X4.3: 0 V_{OUT}</p> <p>X4.4: Output GND</p> <p>X4.5: FE²⁾</p> |
| CPX-AB-8-KL-4POL | | |
|  <p>X1 .0 .0 X5</p> <p> .1 .1</p> <p> .2 .2</p> <p> .3 .3</p> <p>X2 .0 .0 X6</p> <p> .1 .1</p> <p> .2 .2</p> <p> .3 .3</p> <p>X3 .0 .0 X7</p> <p> .1 .1</p> <p> .2 .2</p> <p> .3 .3</p> <p>X4 .0 .0 X8</p> <p> .1 .1</p> <p> .2 .2</p> <p> .3 .3</p> | <p>X1.0: 24 V_{OUT}</p> <p>X1.1: 0 V_{OUT}</p> <p>X1.2: Output GND</p> <p>X1.3: FE</p> <p>X2.0: n.c.</p> <p>X2.1: n.c.</p> <p>X2.2: Output U0+</p> <p>X2.3: FE</p> <p>X3.0: 24 V_{OUT}</p> <p>X3.1: 0 V_{OUT}</p> <p>X3.2: Output GDN</p> <p>X3.3: FE</p> <p>X4.0: n.c.</p> <p>X4.1: n.c.</p> <p>X4.2: Output I0+</p> <p>X4.3: FE</p> | <p>X5.0: 24 V_{OUT}</p> <p>X5.1: 0 V_{OUT}</p> <p>X5.2: Output GND</p> <p>X5.3: FE</p> <p>X6.0: n.c.</p> <p>X6.1: n.c.</p> <p>X6.2: Output U1+</p> <p>X6.3: FE</p> <p>X7.0: 24 V_{OUT}</p> <p>X7.1: 0 V_{OUT}</p> <p>X7.2: Output GND</p> <p>X7.3: FE</p> <p>X8.0: n.c.</p> <p>X8.1: n.c.</p> <p>X8.2: Output I1+</p> <p>X8.3: FE</p> |
| CPX-AB-1-SUB-BU-25POL | | |
|  | <p>1: Output GND</p> <p>2: Output U0+</p> <p>3: Output GND</p> <p>4: Output I0+</p> <p>5: n.c.</p> <p>6: n.c.</p> <p>7: n.c.</p> <p>8: n.c.</p> <p>9: 24 V_{OUT}</p> <p>10: 24 V_{OUT}</p> <p>11: 0 V_{OUT}</p> <p>12: 0 V_{OUT}</p> <p>13: Shielding³⁾</p> | <p>14: Output GND</p> <p>15: Output U1+</p> <p>16: Output GND</p> <p>17: Output I1+</p> <p>18: 24 V_{OUT}</p> <p>19: n.c.</p> <p>20: 24 V_{OUT}</p> <p>21: n.c.</p> <p>22: 0 V_{OUT}</p> <p>23: 0 V_{OUT}</p> <p>24: 0 V_{OUT}</p> <p>25: FE</p> <p>Housing: FE</p> |

1) Speedcon quick lock, additional shielding on metal thread

2) FE/shield additionally on metal thread

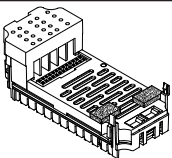
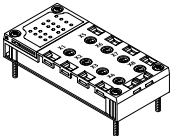
3) Connect shield to functional earth FE

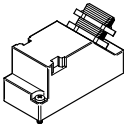
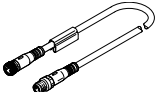
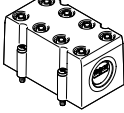
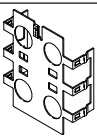
Data sheet – Output module, analogue

| Ordering data | | Part no. | Type |
|--|--|--|------------------------------|
| Designation | | | |
| Output module, analogue | | | |
|  | 2 analogue current or voltage outputs | 526170 | CPX-2AA-U-I |
| Connection block | | | |
|  | Plastic | 4x socket M12, 5-pin | 195704 CPX-AB-4-M12X2-5POL |
| | | 4x socket, M12 with quick-lock technology, 5-pin | 541254 CPX-AB-4-M12X2-5POL-R |
| | | Spring-loaded terminal, 32-pin | 195708 CPX-AB-8-KL-4POL |
| | Metal | 1x socket, Sub-D, 25-pin | 525676 CPX-AB-1-SUB-BU-25POL |
| | | 4x socket M12, 5-pin | 549367 CPX-M-AB-4-M12X2-5POL |
| Plug | | | |
|  | Plug M12, 5-pin | 175487 | SEA-M12-5GS-PG7 |
|  | Sub-D plug, 25-pin | 527522 | SD-SUB-D-ST25 |
| Connecting cable | | | |
|  | Modular system for a choice of connecting cables | – | NEBU-... → Internet: nebu |
| Cover | | | |
|  | Cover for CPX-AB-8-KL-4POL (IP65, IP67) | 538219 | AK-8KL |
| | <ul style="list-style-type: none"> • 8 cable through feeds M9 • 1 cable through feed for multi-pin plug Fittings kit | 538220 | VG-K-M9 |
| Screening plate | | | |
|  | Screening plate for M12 connections | 526184 | CPX-AB-S-4-M12 |
| User documentation | | | |
|  | User documentation | German | 526415 P.BE-CPX-AX-DE |
| | | English | 526416 P.BE-CPX-AX-EN |
| | | Spanish | 526417 P.BE-CPX-AX-ES |
| | | French | 526418 P.BE-CPX-AX-FR |
| | | Italian | 526419 P.BE-CPX-AX-IT |

Data sheet – PROFIsafe shut-off module

Function

The PROFIsafe shut-off module interrupts the contact rails of the interlinking block for valves and outputs. The supply voltage for valves can be switched by the module within the CPX terminal and via a connection block to two consuming devices. Actuation takes place via the bus node (PROFINET) of the CPX terminal.

Area of application

- Output module for 24 V DC supply voltage
- Shut-off module for supply voltage for valves
- Can only be used with PROFINET or PROFIBUS bus nodes
- The shut-off module is supplied with voltage for the electronics and the outputs by the interlinking block
- The outputs are supplied from the power supply for valves (V_{Valves})

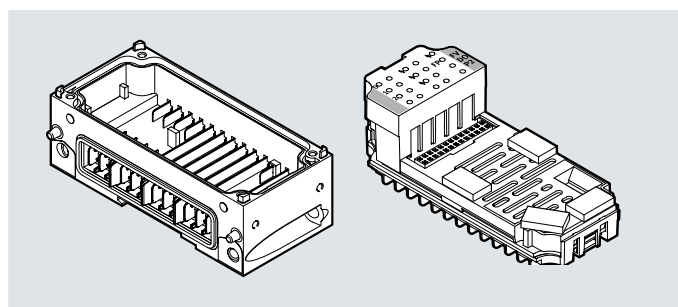

| General technical data | | CPX-FVDA-P2 | |
|--|--------------------------|---|---|
| Type | | CPX-FVDA-P2 | |
| Number of outputs | | 2 | |
| Note on outputs | | 1 internal channel for switching off the supply voltage for valves 2 external outputs | |
| Max. address capacity | Inputs | [B] | 6 |
| | Outputs | [B] | 6 |
| Maximum cable length | | [m] | 200 |
| Max. power supply | Per module | [A] | 5 |
| | Per channel | [A] | 1.5 |
| Fuse protection (short circuit) | | Internal electronic fuse per channel | |
| Current consumption of module | | [mA] | Typically 65 (power supply for valves) |
| | | [mA] | Typically 25 (power supply for electronics) |
| Operating voltage | | [V DC] | 24 |
| | | [V DC] | 20.4 ... 28.8 |
| Voltage drop per channel | | [V] | 0.6 |
| Residual ripple | | [Vss] | 2 within voltage range |
| Load capacity to FE | | [nF] | 400 |
| Max. response time to shut-off command | | [ms] | 23 |
| Galvanic isolation | Channel – channel | No | |
| | Channel – internal bus | Yes, with intermediate supply | |
| Switching logic | Outputs | P-M switching | |
| Safety integrity level | | Safe switch-off, SIL3 | |
| Performance Level | | Safe switch-off/category 3, Performance Level e | |
| Failure rate per hour (PFH) | | 1.0x 10 ⁻⁹ | |
| Certificate issuing authority | | TÜV Rhld 01/205/5294.02/23 | |
| | | TÜV Rhld 01/205U/5294.01/23 | |
| LED displays | Group diagnostics | 1 | |
| | Channel diagnostics | 3 | |
| | Channel status | 3 | |
| | Failsafe protocol active | 1 | |
| Diagnostics | | <ul style="list-style-type: none"> • Short circuit/overload per channel • Undervoltage of valves • Cross circuit • Wire break per channel | |
| Parameterisation | | <ul style="list-style-type: none"> • Monitoring of wire break per channel • Diagnostic behaviour | |
| Degree of protection to EN 60529 | | Depending on connection block | |
| Grid dimension | | [mm] | 50 |
| Dimensions (including interlinking block and connection block) W x L x H | | [mm] | 50 x 107 x 55 |
| Product weight | | [g] | 50 |

Data sheet – PROFIsafe shut-off module

| Materials | |
|-------------------|-------------------|
| Housing | Reinforced PA, PC |
| Note on materials | RoHS-compliant |
| PWIS conformity | VDMA24364-B2-L |

| Operating and environmental conditions | |
|--|---------------------------------|
| Ambient temperature | [°C] -5 ... +50 |
| Storage temperature | [°C] -20 ... +70 |
| CE marking (see declaration of conformity) ¹⁾ | To EU Machinery Directive |
| | To EU EMC Directive |
| | To EU RoHS Directive |
| UKCA marking (see declaration of conformity) ¹⁾ | To UK instructions for machines |
| | To UK instructions for EMC |
| | To UK RoHS instructions |
| Certification | c UL us - Recognized (OL) |

1) Additional information at: www.festo.com/catalogue/... → Support/Downloads.

Connection and display components

CPX-FVDA-P2

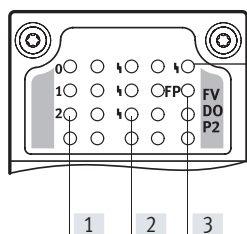

- [1] Status LEDs (yellow):
 - 0: Supply voltage for valves
 - 1: X1
 - 2: X2
- [2] Channel-related error LEDs (red)
- [3] Fail-safe protocol active (green)
- [4] Error LED (red, module error)

Combinations of bus nodes/control blocks and PROFIsafe shut-off module

| Bus node/control block | Part no. | PROFIsafe shut-off module |
|------------------------|----------|---------------------------|
| | | CPX-FVDA-P2 |
| CPX-FB13 | 195740 | ■ |
| CPX-FB43 | 8110369 | ■ |
| CPX-M-FB44 | 8110370 | ■ |
| CPX-M-FB45 | 8110371 | ■ |

Note
 The PROFIsafe shut-off module CPX-FVDA-P2 can only be integrated as of software release 21 or release 30 (in the case of CPX-FB13).

Data sheet – PROFIsafe shut-off module

| Combinations of connection blocks and PROFIsafe shut-off module | | |
|---|----------|---------------------------|
| Connection blocks | Part no. | PROFIsafe shut-off module |
| | | CPX-FVDA-P2 |
| CPX-M-AB-4-M12X2-5POL | 549367 | ■ |
| CPX-AB-8-KL-4POL | 195708 | ■ |

| Pin allocation | |
|--------------------------|-------------|
| Connection block outputs | CPX-FVDA-P2 |

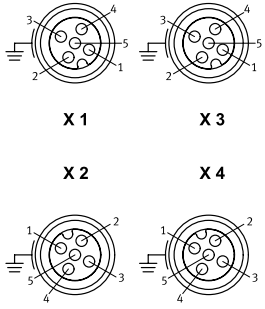
| CPX-M-AB-4-M12X2-5POL | | |
|---|---|---|
|  | <p>X1.1: 0 V_{OUT} 1 (cannot be switched off)</p> <p>X1.2: 24 V_{OUT} 1 (cannot be switched off)</p> <p>X1.3: 0 V_{OUT} 1 (can be switched off via fieldbus)</p> <p>X1.4: 24 V_{OUT} 1 (can be switched off via fieldbus)</p> <p>X1.5: FE</p> <p>X2.1: 0 V_{OUT} 2 (cannot be switched off)</p> <p>X2.2: 24 V_{OUT} 2 (cannot be switched off)</p> <p>X2.3: 0 V_{OUT} 2 (can be switched off via fieldbus)</p> <p>X2.4: 24 V_{OUT} 2 (can be switched off via fieldbus)</p> <p>X2.5: FE</p> | <p>X3.1: n.c.</p> <p>X3.2: n.c.</p> <p>X3.3: n.c.</p> <p>X3.4: n.c.</p> <p>X3.5: FE</p> <p>X4.1: n.c.</p> <p>X4.2: n.c.</p> <p>X4.3: n.c.</p> <p>X4.4: n.c.</p> <p>X4.5: FE</p> |

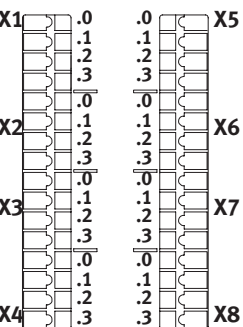
| CPX-AB-8-KL-4POL | | |
|--|---|---|
|  | <p>X1.0: 0 V_{OUT} 1 (cannot be switched off)</p> <p>X1.1: 0 V_{OUT} 1 (can be switched off via fieldbus)</p> <p>X1.2: 24 V_{OUT} 1 (can be switched off via fieldbus)</p> <p>X1.3: FE</p> <p>X2.0: n.c.</p> <p>X2.1: n.c.</p> <p>X2.2: 24 V_{OUT} 1 (cannot be switched off)</p> <p>X2.3: FE</p> <p>X3.0: 0 V_{OUT} 2 (cannot be switched off)</p> <p>X3.1: 0 V_{OUT} 2 (can be switched off via fieldbus)</p> <p>X3.2: 24 V_{OUT} 2 (can be switched off via fieldbus)</p> <p>X3.3: FE</p> <p>X4.0: n.c.</p> <p>X4.1: n.c.</p> <p>X4.2: 24 V_{OUT} 2 (cannot be switched off)</p> <p>X4.3: FE</p> | <p>X5.0: n.c.</p> <p>X5.1: n.c.</p> <p>X5.2: n.c.</p> <p>X5.3: n.c.</p> <p>X6.0: n.c.</p> <p>X6.1: n.c.</p> <p>X6.2: n.c.</p> <p>X6.3: n.c.</p> <p>X7.0: n.c.</p> <p>X7.1: n.c.</p> <p>X7.2: n.c.</p> <p>X7.3: n.c.</p> <p>X8.0: n.c.</p> <p>X8.1: n.c.</p> <p>X8.2: n.c.</p> <p>X8.3: n.c.</p> |



Data sheet – PROFIsafe shut-off module

| Combinations of interlinking blocks and PROFIsafe shut-off module | | |
|---|----------|---------------------------|
| Interlinking blocks | Part no. | PROFIsafe shut-off module |
| | | CPX-FVDA-P2 |
| CPX-GE-EV-S | 195746 | - |
| CPX-GE-EV-S-VL | 8022170 | - |
| CPX-GE-EV-S-7/8-4POL | 541248 | - |
| CPX-GE-EV-S-7/8-5POL | 541244 | - |
| CPX-GE-EV-S-7/8-5POL-VL | 8022172 | - |
| CPX-M-GE-EV-S-7/8-CIP-4P | 568956 | - |
| CPX-M-GE-EV-S-7/8-5POL | 550208 | - |
| CPX-M-GE-EV-S-7/8-5POL-VL | 8022165 | - |
| CPX-M-GE-EV-S-M12-5POL | 8098392 | - |
| CPX-M-GE-EV-S-PP-5POL | 563057 | - |
| CPX-GE-EV | 195742 | - |
| CPX-M-GE-EV | 550206 | - |
| CPX-M-GE-EV-FVO | 567806 | ■ |
| CPX-GE-EV-Z | 195744 | - |
| CPX-GE-EV-Z-VL | 8022166 | - |
| CPX-GE-EV-Z-7/8-4POL | 541250 | - |
| CPX-GE-EV-Z-7/8-5POL | 541246 | - |
| CPX-GE-EV-Z-7/8-5POL-VL | 8022173 | - |
| CPX-M-GE-EV-Z-7/8-5POL | 550210 | - |
| CPX-M-GE-EV-Z-7/8-5POL-VL | 8022158 | - |
| CPX-M-GE-EV-Z-PP-5POL | 563058 | - |
| CPX-GE-EV-V | 533577 | - |
| CPX-GE-EV-V-VL | 8022171 | - |
| CPX-GE-EV-V-7/8-4POL | 541252 | - |
| CPX-M-GE-EV-W-M12-5POL | 8098391 | - |

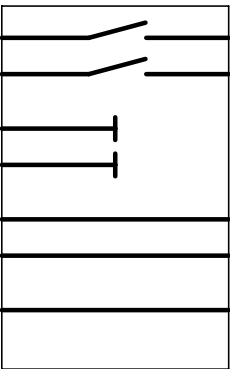
| General technical data | | |
|--|--------|-------------------------------|
| Type | | CPX-M-GE-EV-FVO |
| Nominal operating voltage | [V DC] | 24 |
| Acceptable current load (per contact/contact rail) | [A] | 16 |
| Degree of protection to EN 60529 | | Depending on connection block |
| Ambient temperature | [°C] | -5 ... +50 |
| Certification | | c UL us - Recognized (OL) |
| Note on materials | | RoHS-compliant |
| Materials | | Die-cast aluminium |
| PWIS conformity | | VDMA24364-B2-L |
| Type of mounting | | Angled fitting |
| Grid dimension | [mm] | 50 |
| Dimensions W x L x H | [mm] | 50 x 107 x 35 |
| Product weight | [g] | 170 |

| Pin allocation | | | |
|--|--|-----|------------|
| Circuitry | | Pin | Allocation |
|  <p>0V Valves 24V Valves 0V Output 24V Output 0V El./Sen. 24V El./Sen. FE</p> | | - | - |
| | | - | - |
| | | - | - |
| | | - | - |
| | | | |
| | | | |
| | | | |
| | | | |
| | | | |
| | | | |

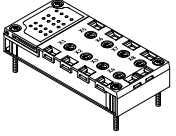
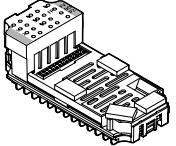
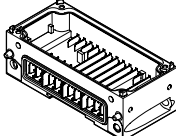
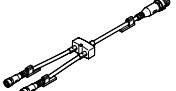
Data sheet – PROFIsafe shut-off module

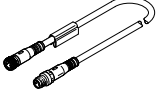
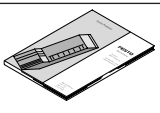
| Ordering data | | Description | Part no. | Type |
|---|---|--|----------------|-------------------------------------|
| PROFIsafe shut-off module | | | | |
|  | Metal connection block | 4x socket, M12, 5-pin | 549367 | CPX-M-AB-4-M12X2-5POL |
| | Plastic connection block | Spring-loaded terminal, 32-pin | 195708 | CPX-AB-8-KL-4POL |
|  | Electronics module (can only be used with CPX-M-GE-EV-FVO) | PROFINET, PROFIBUS | 1971599 | CPX-FVDA-P2 |
|  | Metal interlinking block (for CPX-FVDA-P2 only) | | 567806 | CPX-M-GE-EV-FVO |
| Distributor | | | | |
|  | Modular system for all types of sensor/actuator distributor | | – | NEDY-... → Internet: nedy |
|  | 1x plug M12, 4-pin | 2x socket M12, 5-pin | 8005310 | NEDY-L2R1-V1-M12G5-N-M12G4 |
| Plug | | | | |
|  | Plug | M12, PG7 | 18666 | SEA-GS-7 |
| | | M12, PG7, 4-pin for cable \varnothing 2.5 mm | 192008 | SEA-4GS-7-2.5 |
| | | M12, PG9 | 18778 | SEA-GS-9 |
| | | M12 for 2 cables | 18779 | SEA-GS-11-DUO |
| | | M12 for 2 cables, 5-pin | 192010 | SEA-5GS-11-DUO |
| | | M12, 5-pin | 175487 | SEA-M12-5GS-PG7 |
| Connecting cable | | | | |
|  | Modular system for a choice of connecting cables | | – | NEBU-... → Internet: nebu |
| User documentation | | | | |
|  | User documentation for PROFIsafe shut-off module | German | 8022606 | CPX-FVDA-P2-DE |
| | | English | 8022607 | CPX-FVDA-P2-EN |
| | | Spanish | 8022608 | CPX-FVDA-P2-ES |
| | | French | 8022609 | CPX-FVDA-P2-FR |
| | | Italian | 8022610 | CPX-FVDA-P2-IT |
| | | Chinese | 8022611 | CPX-FVDA-P2-ZH |

Data sheet – End plate with system supply

Function

End plates form the outer edge of the CPX terminal.

The earth connection and mounting holes for wall or H-rail mounting are located on the left-hand end plate.

The end plate with system supply has contact rails from which the other CPX components on the interlinking modules are supplied with power.

Area of application

- 24 V DC supply voltage for the electronics of the CPX terminal
- 24 V DC supply voltage for inputs
- 24 V DC supply voltage for valves
- 24 V DC supply voltage for outputs

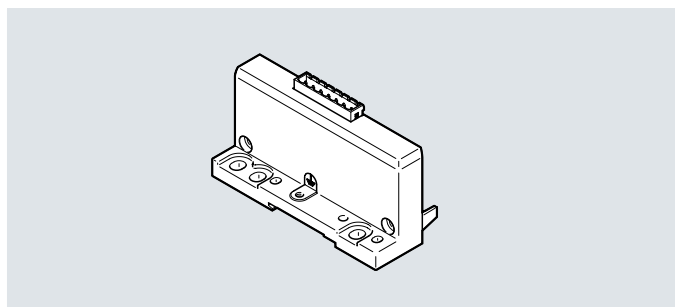

| General technical data | | |
|------------------------|-----|---------------|
| Electrical connection | | Plug, 7-pin |
| Type of mounting | | Tie rods |
| Power supply | | System supply |
| Maximum power supply | [A] | 12 |
| Product weight | [g] | 145 |

| Materials | |
|-------------------|-----------------------------|
| Housing | Die-cast aluminium, painted |
| Note on materials | RoHS-compliant |
| PWIS conformity | VDMA24364-B2-L |

| Operating and environmental conditions | |
|--|---------------------------|
| Certification | c UL us - Recognized (OL) |

| Pin allocation | | |
|--------------------|-----|--|
| Circuitry | Pin | Allocation |
| Plug, 7-pin | | |
| | [1] | 0 V power supply for valves |
| | [2] | 24 V DC load voltage supply for valves |
| | [3] | 0 V power supply for outputs |
| | [4] | 24 V DC load voltage supply for outputs |
| | [5] | 0 V power supply for electronics and sensors |
| | [6] | 24 V DC power supply for electronics and sensors |
| | [7] | FE |

Data sheet – End plate with system supply

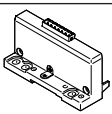
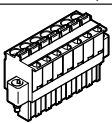
| Ordering data | | Part no. | Type |
|---|--|----------------------------------|--------------|
| End plate with system supply | | | |
|  | End plate for CPX terminal in plastic design | 576315 | CPX-EPL-EV-S |
| Terminal strip | | | |
|  | Plug, 7-pin, straight | Spring-loaded terminal 576319 | NECU-L3G7-C1 |

Data sheet – End plate with extension

Function

End plates form the outer edge of the CPX terminal.
 The earth connection and mounting holes for wall or H-rail mounting are located on the left-hand end plates.
 The end plates with extension enable the CPX terminal to be separated into two interconnected terminals. Control is provided via a common bus node or control block.

Area of application

- Separation of long CPX terminals into two shorter units
- Adaptation for installation in a control cabinet

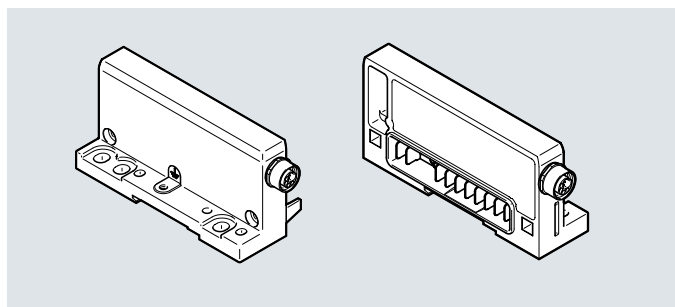

| General technical data | | |
|------------------------|----------|----------------|
| Type | CPX-EP.. | CPX-M-EP.. |
| Type of mounting | Tie rods | Angled fitting |
| Maximum power supply | [A] 6 | 6 |

| Materials | | |
|-------------------|-----------------------------|--------------------|
| Type | CPX-EP.. | CPX-M-EP.. |
| Housing | Die-cast aluminium, painted | Die-cast aluminium |
| Note on materials | RoHS-compliant | RoHS-compliant |
| PWIS conformity | VDMA24364-B2-L | VDMA24364-B2-L |

| Operating and environmental conditions | |
|--|---------------------------|
| Certification | c UL us - Recognized (OL) |

Data sheet – End plate with extension

| Pin allocation – End plate with extension | | | | |
|---|-------------------|---|-----|----------------------------------|
| Circuitry | Pin | Allocation | Pin | Circuitry |
| Right-hand end plate (first row) | Round plug, 8-pin | | | Left-hand end plate (second row) |
| | M12 | | | |
| | 1 | 0 V DC supply voltage for electronics and sensors | 1 | |
| | 2 | 0 V DC load voltage supply for valves | 2 | |
| | 3 | 24 V DC load voltage supply for valves | 3 | |
| | 4 | 24 V DC power supply for electronics and sensors | 4 | |
| | 5 | Bus signal | 5 | |
| | 6 | Bus signal | 6 | |
| | 7 | Bus signal | 7 | |
| | 8 | Bus signal | 8 | |
| Housing | FE | Housing | | |

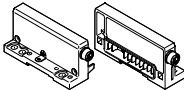
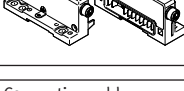
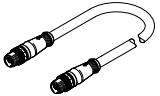
| Ordering data | | | | Weight [g] | Part no. | Type |
|---|------------------------------------|---------------------------------|-----|---------------|-------------------------------------|------|
| End plate with extension | | | | | | |
|  | For CPX terminal in plastic design | First row, right-hand end plate | 190 | 576313 | CPX-EPR-EV-X | |
| | | Second row, left-hand end plate | 175 | 576314 | CPX-EPL-EV-X | |
|  | For CPX terminal in metal design | First row, right-hand end plate | 190 | 576316 | CPX-M-EPR-EV-X | |
| | | Second row, left-hand end plate | 175 | 576317 | CPX-M-EPL-EV-X | |
| Connecting cable | | | | | | |
|  | 8-pin | 0.25 m | 47 | 564189 | NEBC-F12G8-KH-0.25-N-S-F12G8 | |
| | | 0.5 m | 69 | 564190 | NEBC-F12G8-KH-0.5-N-S-F12G8 | |
| | | 1 m | 113 | 564191 | NEBC-F12G8-KH-1-N-S-F12G8 | |
| | | 1.5 m | 154 | 564192 | NEBC-F12G8-KH-1.5-N-S-F12G8 | |
| | | 2 m | 200 | 576015 | NEBC-F12G8-KH-2-N-S-F12G8 | |
| | | 3 m | 280 | 576636 | NEBC-F12G8-KH-3-N-S-F12G8 | |

Data sheet – Interlinking block with system supply

Function

Interlinking blocks ensure the electrical supply of all other CPX modules. They have contact rails, from which the other CPX components on the interlinking modules are supplied with power. Internal division of the power supply makes it possible to switch off specific areas of the sensors and actuators individually.

Area of application

- 24 V DC supply voltage for the electronics of the CPX terminal
- 24 V DC supply voltage for inputs
- 24 V DC supply voltage for valves
- 24 V DC supply voltage for outputs

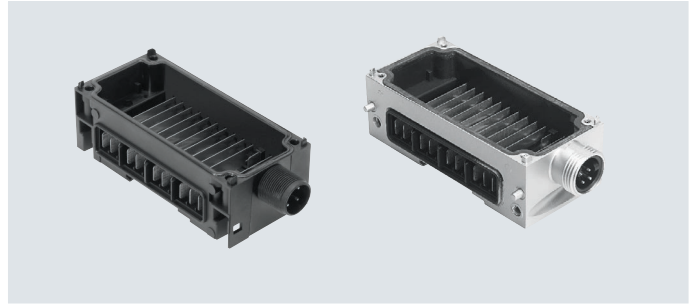

| General technical data | | |
|----------------------------------|--------|-------------------------------|
| Nominal operating voltage | [V DC] | 24 |
| Degree of protection to EN 60529 | | Depending on connection block |
| Ambient temperature | [°C] | -5 ... +50 |
| Note on materials | | RoHS-compliant |
| PWIS conformity | | VDMA24364-B2-L |
| Grid dimension | [mm] | 50 |
| Dimensions W x L x H | [mm] | 50 x 107 x 35 |

| Technical data – Plastic interlinking blocks | | | CPX-GE-EV-S | | | | |
|--|-------------------------|-----|---------------|--------|-------------|-------------|--------------|
| Type | | | | -VL | -7/8-4POL | -7/8-5POL | -7/8-5POL-VL |
| Electrical connection | | | M18 | M18 | 7/8", 4-pin | 7/8", 5-pin | 7/8", 5-pin |
| Power supply | Sensors and electronics | [A] | Max. 16 | Max. 8 | Max. 10 | Max. 8 | Max. 8 |
| | Valves and outputs | [A] | Max. 16 | Max. 8 | Max. 10 | Max. 8 | Max. 8 |
| Corrosion resistance class CRC ¹⁾ | | | 1 | | | | |
| Type of mounting | | | Tie rods | | | | |
| Materials | | | PA-reinforced | | | | |
| Product weight | | [g] | 125 | | | | |

1) Additional information: www.festo.com/x/topic/kbk

Data sheet – Interlinking block with system supply

| Technical data – Metal interlinking blocks | | CPX-M-GE-EV-S | | | | |
|--|-----------------------------|--------------------|-------------|------------------------|--------------|-----------------------|
| | | -7/8-CIP-4P | -7/8-5POL | -M12-5POL | -7/8-5POL-VL | -PP-5POL |
| Type | | | | | | |
| Electrical connection | | 7/8", 4-pin | 7/8", 5-pin | Plug | 7/8", 5-pin | AIDA push-pull, 5-pin |
| | | | | M12x1 | | |
| | | | | 5-pin | | |
| | | | | L-coded | | |
| Power supply | Sensors and electronics [A] | Max. 10 | Max. 8 | Max. 16 | Max. 8 | Max. 16 |
| | Valves and outputs [A] | Max. 10 | Max. 8 | Max. 16 | Max. 8 | Max. 16 |
| Corrosion resistance class CRC ¹⁾ | | 0 | | | | |
| Type of mounting | | Angled fitting | | | | |
| Materials | | Die-cast aluminium | | | | |
| Certification | | – | – | c UL - Recognized (OL) | – | – |
| Product weight [g] | | 187 | 187 | 266 | 187 | 279 |

1) Additional information: www.festo.com/x/topic/kbk

**Note**

Points to note about the interlinking block CPX-M-GE-EV-S-7/8-CIP-4P:

- Must be mounted as the first module to the right of the left-hand end plate
- The functional earth (FE) must be connected via the left-hand end plate
- Only permitted as an interlinking block to a bus node

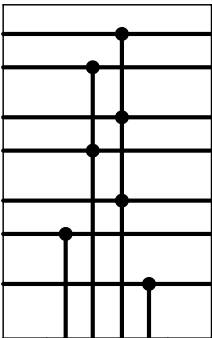
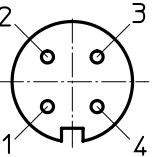
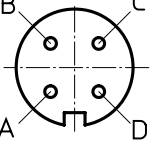

Data sheet – Interlinking block with system supply

Pin allocation – Plastic interlinking blocks

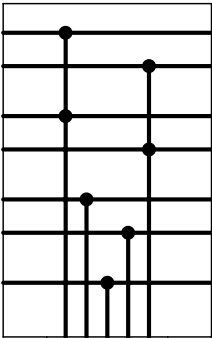
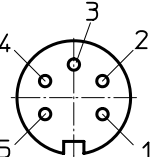
| Circuitry | Pin | Allocation | | | | | | | | | | | | | | | |
|---|---|--|--|--|--|--|----|-----|----|----|--|-----|-----|----|----|--|--|
| Round plug, 4-pin | | | | | | | | | | | | | | | | | |
|  <p>0V Valves 24V Valves 0V Output 24V Output 0V El./Sen. 24V El./Sen. FE</p> |  <p>M18</p> | <table border="1"> <tr><td>1</td><td>24 V DC power supply for electronics and sensors</td></tr> <tr><td>2</td><td>24 V DC load voltage supply for valves and outputs</td></tr> <tr><td>3</td><td>0 V</td></tr> <tr><td>4</td><td>FE</td></tr> </table> | 1 | 24 V DC power supply for electronics and sensors | 2 | 24 V DC load voltage supply for valves and outputs | 3 | 0 V | 4 | FE | | | | | | | |
| | 1 | 24 V DC power supply for electronics and sensors | | | | | | | | | | | | | | | |
| 2 | 24 V DC load voltage supply for valves and outputs | | | | | | | | | | | | | | | | |
| 3 | 0 V | | | | | | | | | | | | | | | | |
| 4 | FE | | | | | | | | | | | | | | | | |
|  <p>7/8"</p> | <table border="1"> <tr><td>A</td><td>24 V DC supply voltage for electronics and sensors</td></tr> <tr><td>B</td><td>24 V DC load voltage supply for valves and outputs</td></tr> <tr><td>C</td><td>FE</td></tr> <tr><td>D</td><td>0V</td></tr> </table> | A | 24 V DC supply voltage for electronics and sensors | B | 24 V DC load voltage supply for valves and outputs | C | FE | D | 0V | | | | | | | | |
| A | 24 V DC supply voltage for electronics and sensors | | | | | | | | | | | | | | | | |
| B | 24 V DC load voltage supply for valves and outputs | | | | | | | | | | | | | | | | |
| C | FE | | | | | | | | | | | | | | | | |
| D | 0V | | | | | | | | | | | | | | | | |
| <table border="1"> <tr><td>M18</td><td>1</td><td>2</td><td>3</td><td>4</td></tr> <tr><td>7/8"</td><td>A</td><td>B</td><td>D</td><td>C</td></tr> <tr><td></td><td>24V</td><td>24V</td><td>0V</td><td>FE</td></tr> </table> | M18 | 1 | 2 | 3 | 4 | 7/8" | A | B | D | C | | 24V | 24V | 0V | FE | | |
| M18 | 1 | 2 | 3 | 4 | | | | | | | | | | | | | |
| 7/8" | A | B | D | C | | | | | | | | | | | | | |
| | 24V | 24V | 0V | FE | | | | | | | | | | | | | |

| | | | | | | | | | | | | | | |
|--|---|---|----|------------------------|-----|-----------------------------|---|----|----|--|-----|--|--|--|
| Round plug, 5-pin | | | | | | | | | | | | | | |
|  <p>0V Valves 24V Valves 0V Output 24V Output 0V El./Sen. 24V El./Sen. FE</p> |  <p>7/8"</p> | <table border="1"> <tr><td>1</td><td>0 V valves and outputs</td></tr> <tr><td>2</td><td>0 V electronics and sensors</td></tr> <tr><td>3</td><td>FE</td></tr> <tr><td>4</td><td>24 V DC power supply for electronics and sensors</td></tr> <tr><td>5</td><td>24 V DC load voltage supply for valves and outputs</td></tr> </table> | 1 | 0 V valves and outputs | 2 | 0 V electronics and sensors | 3 | FE | 4 | 24 V DC power supply for electronics and sensors | 5 | 24 V DC load voltage supply for valves and outputs | | |
| | 1 | 0 V valves and outputs | | | | | | | | | | | | |
| 2 | 0 V electronics and sensors | | | | | | | | | | | | | |
| 3 | FE | | | | | | | | | | | | | |
| 4 | 24 V DC power supply for electronics and sensors | | | | | | | | | | | | | |
| 5 | 24 V DC load voltage supply for valves and outputs | | | | | | | | | | | | | |
| <table border="1"> <tr><td>7/8"</td><td>1</td><td>2</td><td>3</td><td>4</td><td>5</td></tr> <tr><td></td><td>0V</td><td>0V</td><td>FE</td><td>24V</td><td>24V</td></tr> </table> | 7/8" | 1 | 2 | 3 | 4 | 5 | | 0V | 0V | FE | 24V | 24V | | |
| 7/8" | 1 | 2 | 3 | 4 | 5 | | | | | | | | | |
| | 0V | 0V | FE | 24V | 24V | | | | | | | | | |

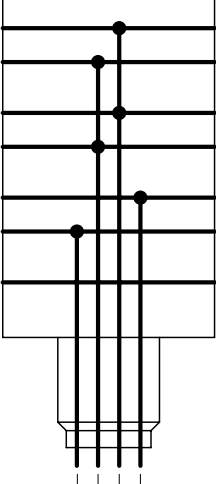
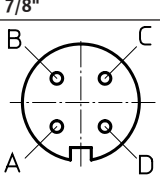

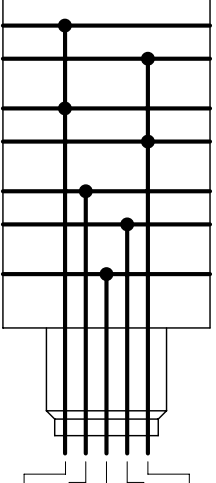
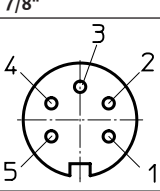
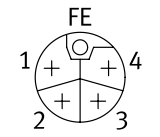

Data sheet – Interlinking block with system supply

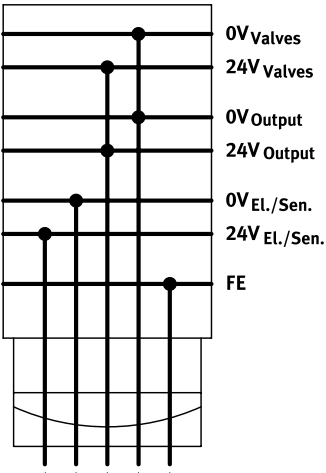
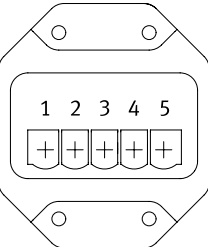
| Pin allocation – Metal interlinking blocks | | Pin | Allocation | | | | | | | | | | | | | | | | | | |
|---|---|---|--|-----|-----|---|-----|-----|----|----|---|---|--|----|----|----|-----|-----|--|--|--|
| Circuitry | | | | | | | | | | | | | | | | | | | | | |
| Round plug, 4-pin | | | | | | | | | | | | | | | | | | | | | |
|  <p>0V Valves 24V Valves 0V Output 24V Output 0V El./Sen. 24V El./Sen. FE</p> |  <p>7/8"</p> | A | 24 V DC supply voltage for electronics and sensors | | | | | | | | | | | | | | | | | | |
| | | B | 24 V DC load voltage supply for valves and outputs | | | | | | | | | | | | | | | | | | |
| | | C | 0 V DC supply voltage for electronics and sensors | | | | | | | | | | | | | | | | | | |
| | | D | 0 V DC load voltage supply for valves and outputs | | | | | | | | | | | | | | | | | | |
| | | <p>-  - Note The functional earth (FE) must be connected via the left-hand end plate.</p> | | | | | | | | | | | | | | | | | | | |
| <table border="1" data-bbox="151 884 391 940"> <tr> <td>7/8"</td> <td>A</td> <td>B</td> <td>D</td> <td>C</td> </tr> <tr> <td></td> <td>24V</td> <td>24V</td> <td>0V</td> <td>0V</td> </tr> </table> | 7/8" | A | B | D | C | | 24V | 24V | 0V | 0V | | | | | | | | | | | |
| 7/8" | A | B | D | C | | | | | | | | | | | | | | | | | |
| | 24V | 24V | 0V | 0V | | | | | | | | | | | | | | | | | |
| Round plug, 5-pin | | | | | | | | | | | | | | | | | | | | | |
|  <p>0V Valves 24V Valves 0V Output 24V Output 0V El./Sen. 24V El./Sen. FE</p> |  <p>7/8"</p> | 1 | 0 V valves and outputs | | | | | | | | | | | | | | | | | | |
| | | 2 | 0 V electronics and sensors | | | | | | | | | | | | | | | | | | |
| | | 3 | FE | | | | | | | | | | | | | | | | | | |
| | | 4 | 24 V DC power supply for electronics and sensors | | | | | | | | | | | | | | | | | | |
| | | 5 | 24 V DC load voltage supply for valves and outputs | | | | | | | | | | | | | | | | | | |
| | | <p>M12</p>  | | | | | | | | | | | | | | | | | | | |
| | | 1 | 24 V DC power supply for electronics and sensors | | | | | | | | | | | | | | | | | | |
| | | 2 | 0 V valves and outputs | | | | | | | | | | | | | | | | | | |
| | | 3 | 0 V electronics and sensors | | | | | | | | | | | | | | | | | | |
| | | 4 | 24 V DC load voltage supply for valves and outputs | | | | | | | | | | | | | | | | | | |
| | | FE | FE | | | | | | | | | | | | | | | | | | |
| <table border="1" data-bbox="127 1512 406 1590"> <tr> <td>7/8"</td> <td>1</td> <td>2</td> <td>3</td> <td>4</td> <td>5</td> </tr> <tr> <td>M12</td> <td>2</td> <td>3</td> <td>5</td> <td>1</td> <td>4</td> </tr> <tr> <td></td> <td>0V</td> <td>0V</td> <td>FE</td> <td>24V</td> <td>24V</td> </tr> </table> | 7/8" | 1 | 2 | 3 | 4 | 5 | M12 | 2 | 3 | 5 | 1 | 4 | | 0V | 0V | FE | 24V | 24V | | | |
| 7/8" | 1 | 2 | 3 | 4 | 5 | | | | | | | | | | | | | | | | |
| M12 | 2 | 3 | 5 | 1 | 4 | | | | | | | | | | | | | | | | |
| | 0V | 0V | FE | 24V | 24V | | | | | | | | | | | | | | | | |

Data sheet – Interlinking block with system supply

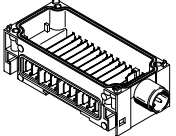
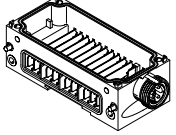
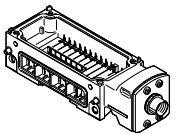
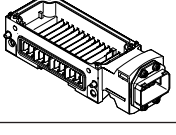
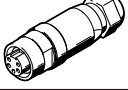
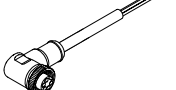
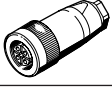
| Pin allocation – Metal interlinking blocks | | Pin | Allocation | | | | | | | | | | | | |
|--|---|--|--|----|----|---|--|-----|----|-----|----|----|--|--|--|
| Circuitry | | | | | | | | | | | | | | | |
| 5-pin push-pull plug | | | | | | | | | | | | | | | |
|  | Plug pattern to PROFINET specification | | | | | | | | | | | | | | |
| |  | 1 | 24 V DC power supply for electronics and sensors | | | | | | | | | | | | |
| | 2 | 0 V electronics and sensors | | | | | | | | | | | | | |
| | 3 | 24 V DC load voltage supply for valves and outputs | | | | | | | | | | | | | |
| | 4 | 0 V valves and outputs | | | | | | | | | | | | | |
| | 5 | FE | | | | | | | | | | | | | |
| <table border="1" data-bbox="111 873 391 940"> <tr> <td>PP</td> <td>1</td> <td>2</td> <td>3</td> <td>4</td> <td>5</td> </tr> <tr> <td></td> <td>24V</td> <td>0V</td> <td>24V</td> <td>0V</td> <td>FE</td> </tr> </table> | PP | 1 | 2 | 3 | 4 | 5 | | 24V | 0V | 24V | 0V | FE | | | |
| PP | 1 | 2 | 3 | 4 | 5 | | | | | | | | | | |
| | 24V | 0V | 24V | 0V | FE | | | | | | | | | | |

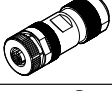

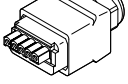
Data sheet – Interlinking block with system supply

| Ordering data | | | | Part no. | Type | |
|---|---|---------------------------|----------------------|----------|--------------------------|------------------------|
| Designation | | | | | | |
| Interlinking block with system supply | | | | | | |
|  | M18 connection, plastic interlinking block | 4-pin | – | 195746 | CPX-GE-EV-S | |
| | | | For ATEX environment | 8022170 | CPX-GE-EV-S-VL | |
|  | 7/8" connection, plastic interlinking block | 4-pin | – | 541248 | CPX-GE-EV-S-7/8-4POL | |
| | | | 5-pin | – | 541244 | CPX-GE-EV-S-7/8-5POL |
| | | | For ATEX environment | 8022172 | CPX-GE-EV-S-7/8-5POL-VL | |
| | 7/8" connection, metal interlinking block | 4-pin | – | 568956 | CPX-M-GE-EV-S-7/8-CIP-4P | |
| | | | 5-pin | – | 550208 | CPX-M-GE-EV-S-7/8-5POL |
| For ATEX environment | 8022165 | CPX-M-GE-EV-S-7/8-5POL-VL | | | | |
|  | M12x1 L-coded connection, metal interlinking block | 5-pin | – | 8098392 | CPX-M-GE-EV-S-M12-5POL | |
|  | Push-pull plug connection (AIDA), metal interlinking block | 5-pin | – | 563057 | CPX-M-GE-EV-S-PP-5POL | |
| Connection sockets 7/8" | | | | | | |
|  | Power supply socket | 5-pin | – | 543107 | NECU-G78G5-C2 | |
| | | 4-pin | – | 543108 | NECU-G78G4-C2 | |
|  | Angled socket, 5-pin – open cable end, 5-wire | 2 m | – | 573855 | NEBU-G78W5-K-2-N-LE5 | |
| M18 connection sockets | | | | | | |
|  | Straight socket, screw terminal | 4-pin | PG9 | 18493 | NTSD-GD-9 | |
| | | | PG13.5 | 18526 | NTSD-GD-13.5 | |
|  | Angled socket, screw terminal | 4-pin | PG9 | 18527 | NTSD-WD-9 | |
| | Angled socket, screw terminal | 4-pin | PG11 | 533119 | NTSD-WD-11 | |
| Power supply sockets M12 | | | | | | |
|  | Straight socket, screw terminal | 5-pin | – | 8166793 | NECL-L12G5-C2-Q10 | |
|  | Angled socket, screw terminal | 5-pin | – | 8166794 | NECL-L12W5-C2-Q10 | |
| Push-pull power supply socket | | | | | | |
|  | Socket, spring-loaded terminal, plug pattern PP, fulfils requirements to AIDA | 5-pin | – | 5195383 | NECU-M-PPG5PP-C1-PN | |

Data sheet – Interlinking block with system supply

| Ordering data | | Part no. | Type |
|--|---|-----------------------------------|----------------------------------|
| Designation | | | |
| Mounting accessories | | | |
|  | Screws for mounting the bus node/connection block on the plastic interlinking block | Bus node/metal connection block | 550218 CPX-DPT-30X32-S-4X |
| | Screws for mounting the bus node/connection block on the metal interlinking block | Bus node/plastic connection block | 550219 CPX-M-M3x22-4x |
| | | Bus node/metal connection block | 550216 CPX-M-M3x22-S-4x |

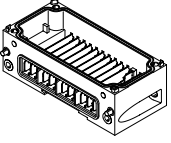
Data sheet – Interlinking block without power supply

| Ordering data | | Part no. | Type | |
|--|---|-----------------------------------|-------------|--------------------|
| Designation | | | | |
| Interlinking block without power supply | | | | |
|  | Plastic interlinking block | 195742 | CPX-GE-EV | |
| | Metal interlinking block | 550206 | CPX-M-GE-EV | |
| Mounting accessories | | | | |
|  | Screws for mounting the bus node/connection block on the plastic interlinking block | Bus node/metal connection block | 550218 | CPX-DPT-30X32-S-4X |
| | | Bus node/plastic connection block | 550219 | CPX-M-M3x22-4x |
| | Screws for mounting the bus node/connection block on the metal interlinking block | Bus node/metal connection block | 550216 | CPX-M-M3x22-S-4x |

Data sheet – Interlinking block with additional supply for outputs

Function

Interlinking blocks ensure the electrical supply of all other CPX modules. They have contact rails, from which the other CPX components on the interlinking modules are supplied with power. Internal division of the power supply makes it possible to switch off specific areas of the sensors and actuators individually.

Area of application

- 24 V DC supply voltage for outputs

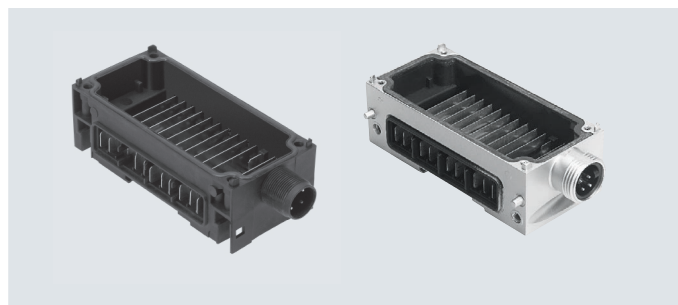

| General technical data | | |
|----------------------------------|--------|-------------------------------|
| Nominal operating voltage | [V DC] | 24 |
| Degree of protection to EN 60529 | | Depending on connection block |
| Ambient temperature | [°C] | -5 ... +50 |
| Note on materials | | RoHS-compliant |
| PWIS conformity | | VDMA24364-B2-L |
| Grid dimension | [mm] | 50 |
| Dimensions W x L x H | [mm] | 50 x 107 x 35 |

| Technical data – Plastic interlinking blocks | | | | | |
|--|---------|---------------|-----------|-------------|--------------|
| Type | | CPX-GE-EV-Z | | | |
| | | -VL | -7/8-4POL | -7/8-5POL | -7/8-5POL-VL |
| Electrical connection | | M18 | M18 | 7/8", 4-pin | 7/8", 5-pin |
| Power supply | Outputs | [A] | Max. 16 | Max. 8 | Max. 10 |
| Materials | | PA-reinforced | | | |
| Product weight | | [g] | 125 | | |

| Technical data – Metal interlinking blocks | | | |
|--|---------|--------------------|--------------|
| Type | | CPX-M-GE-EV-Z | |
| | | -7/8-5POL | -7/8-5POL-VL |
| Electrical connection | | 7/8", 5-pin | 7/8", 5-pin |
| Power supply | Outputs | [A] | Max. 8 |
| Materials | | Die-cast aluminium | |
| Product weight | | [g] | 187 |
| | | | 187 |
| | | | 279 |

Data sheet – Interlinking block with additional supply for outputs

Pin allocation – Plastic interlinking blocks



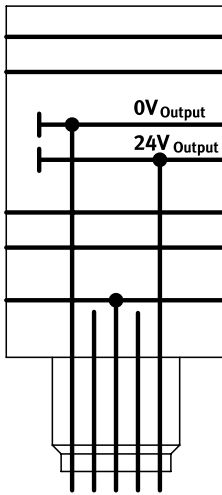
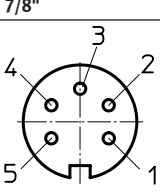
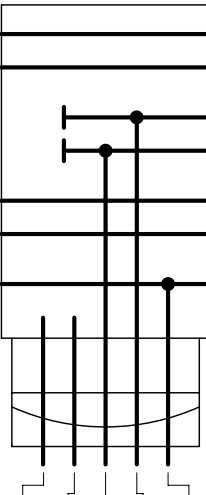
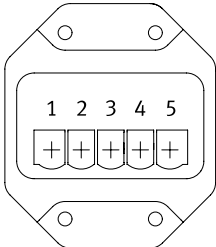

| Circuitry | | Pin | Allocation | | | | | | | | | | | | | | | | |
|--|--------------|-------------|------------|---|---|-------------|---|---|---|---|--|------|-----|----|----|--|--|--|--|
| Round plug, 4-pin | | | | | | | | | | | | | | | | | | | |
| | 0V Valves | | 1 | n.c. | | | | | | | | | | | | | | | |
| | 24V Valves | | 2 | 24 V DC load voltage supply for outputs | | | | | | | | | | | | | | | |
| 0V Output | 0V Output | 3 | 0 V | | | | | | | | | | | | | | | | |
| 24V Output | 24V Output | 4 | FE | | | | | | | | | | | | | | | | |
| 0V EL./Sen. | 0V EL./Sen. | 7/8" | | | | | | | | | | | | | | | | | |
| 24V EL./Sen. | 24V EL./Sen. | | A | n.c. | | | | | | | | | | | | | | | |
| FE | FE | | B | 24 V DC load voltage supply for outputs | | | | | | | | | | | | | | | |
| | | | C | FE | | | | | | | | | | | | | | | |
| | | | D | 0V | | | | | | | | | | | | | | | |
| <table border="1"> <tr> <td>M18</td> <td>1</td> <td>2</td> <td>3</td> <td>4</td> </tr> <tr> <td>7/8"</td> <td>A</td> <td>B</td> <td>D</td> <td>C</td> </tr> <tr> <td></td> <td>n.c.</td> <td>24V</td> <td>0V</td> <td>FE</td> </tr> </table> | M18 | 1 | 2 | 3 | 4 | 7/8" | A | B | D | C | | n.c. | 24V | 0V | FE | | | | |
| M18 | 1 | 2 | 3 | 4 | | | | | | | | | | | | | | | |
| 7/8" | A | B | D | C | | | | | | | | | | | | | | | |
| | n.c. | 24V | 0V | FE | | | | | | | | | | | | | | | |

| | | | | | | | | | | | | | | | | |
|--|--------------|------|---|-------------|-----|---|--|----|------|----|------|-----|--|--|--|--|
| Round plug, 5-pin | | | | | | | | | | | | | | | | |
| | 0V Valves | | 1 | 0 V outputs | | | | | | | | | | | | |
| | 24V Valves | | 2 | n.c. | | | | | | | | | | | | |
| 0V Output | 0V Output | 3 | FE | | | | | | | | | | | | | |
| 24V Output | 24V Output | 4 | n.c. | | | | | | | | | | | | | |
| 0V EL./Sen. | 0V EL./Sen. | 5 | 24 V DC load voltage supply for outputs | | | | | | | | | | | | | |
| 24V EL./Sen. | 24V EL./Sen. | | | | | | | | | | | | | | | |
| FE | FE | | | | | | | | | | | | | | | |
| <table border="1"> <tr> <td>7/8"</td> <td>1</td> <td>2</td> <td>3</td> <td>4</td> <td>5</td> </tr> <tr> <td></td> <td>0V</td> <td>n.c.</td> <td>FE</td> <td>n.c.</td> <td>24V</td> </tr> </table> | 7/8" | 1 | 2 | 3 | 4 | 5 | | 0V | n.c. | FE | n.c. | 24V | | | | |
| 7/8" | 1 | 2 | 3 | 4 | 5 | | | | | | | | | | | |
| | 0V | n.c. | FE | n.c. | 24V | | | | | | | | | | | |

Data sheet – Interlinking block with additional supply for outputs

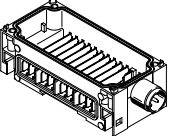
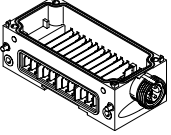
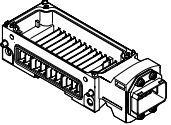
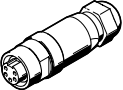
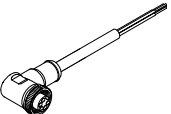
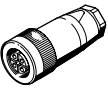
| Pin allocation – Metal interlinking blocks | | Pin | Allocation | | | | | | | | | | | | |
|---|--|---|---|-------------|-------------|---|------|------|---|-----|-------------|-----|---|--|--|
| Circuitry | | | | | | | | | | | | | | | |
| Round plug, 5-pin | | | | | | | | | | | | | | | |
|  | <p>0V Valves</p> <p>24V Valves</p> <p>0V Output</p> <p>24V Output</p> <p>0V EL./Sen.</p> <p>24V EL./Sen.</p> <p>FE</p> |  | <table border="1"> <tr> <td>1</td> <td>0 V outputs</td> </tr> <tr> <td>2</td> <td>n.c.</td> </tr> <tr> <td>3</td> <td>FE</td> </tr> <tr> <td>4</td> <td>n.c.</td> </tr> <tr> <td>5</td> <td>24 V DC load voltage supply for outputs</td> </tr> </table> | 1 | 0 V outputs | 2 | n.c. | 3 | FE | 4 | n.c. | 5 | 24 V DC load voltage supply for outputs | | |
| | | | 1 | 0 V outputs | | | | | | | | | | | |
| 2 | n.c. | | | | | | | | | | | | | | |
| 3 | FE | | | | | | | | | | | | | | |
| 4 | n.c. | | | | | | | | | | | | | | |
| 5 | 24 V DC load voltage supply for outputs | | | | | | | | | | | | | | |
| <table border="1"> <tr> <td>7/8"</td> <td>1</td> <td>2</td> <td>3</td> <td>4</td> <td>5</td> </tr> <tr> <td></td> <td>0V</td> <td>n.c.</td> <td>FE</td> <td>n.c.</td> <td>24V</td> </tr> </table> | 7/8" | 1 | 2 | 3 | 4 | 5 | | 0V | n.c. | FE | n.c. | 24V | | | |
| 7/8" | 1 | 2 | 3 | 4 | 5 | | | | | | | | | | |
| | 0V | n.c. | FE | n.c. | 24V | | | | | | | | | | |
| 5-pin push-pull plug | | | | | | | | | | | | | | | |
|  | <p>0V Valves</p> <p>24V Valves</p> <p>0V Output</p> <p>24V Output</p> <p>0V EL./Sen.</p> <p>24V EL./Sen.</p> <p>FE</p> | <p>Plug pattern to PROFINET specification</p>  | <table border="1"> <tr> <td>1</td> <td>n.c.</td> </tr> <tr> <td>2</td> <td>n.c.</td> </tr> <tr> <td>3</td> <td>24 V DC load voltage supply for outputs</td> </tr> <tr> <td>4</td> <td>0 V outputs</td> </tr> <tr> <td>5</td> <td>FE</td> </tr> </table> | 1 | n.c. | 2 | n.c. | 3 | 24 V DC load voltage supply for outputs | 4 | 0 V outputs | 5 | FE | | |
| | | | 1 | n.c. | | | | | | | | | | | |
| 2 | n.c. | | | | | | | | | | | | | | |
| 3 | 24 V DC load voltage supply for outputs | | | | | | | | | | | | | | |
| 4 | 0 V outputs | | | | | | | | | | | | | | |
| 5 | FE | | | | | | | | | | | | | | |
| <table border="1"> <tr> <td>PP</td> <td>1</td> <td>2</td> <td>3</td> <td>4</td> <td>5</td> </tr> <tr> <td></td> <td>n.c.</td> <td>n.c.</td> <td>24V</td> <td>0V</td> <td>FE</td> </tr> </table> | PP | 1 | 2 | 3 | 4 | 5 | | n.c. | n.c. | 24V | 0V | FE | | | |
| PP | 1 | 2 | 3 | 4 | 5 | | | | | | | | | | |
| | n.c. | n.c. | 24V | 0V | FE | | | | | | | | | | |

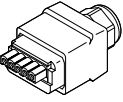
Data sheet – Interlinking block with additional supply for outputs

| Ordering data | | | | Part no. | Type |
|--|---|-----------------------------------|----------------------|---------------------------|-------------------------|
| Designation | | | | | |
| Interlinking block with additional supply for outputs | | | | | |
|  | M18 connection, plastic interlinking block | 4-pin | – | 195744 | CPX-GE-EV-Z |
| | M18 connection, plastic interlinking block | 4-pin | For ATEX environment | 8022166 | CPX-GE-EV-Z-VL |
|  | 7/8" connection, plastic interlinking block | 4-pin | – | 541250 | CPX-GE-EV-Z-7/8-4POL |
| | | 5-pin | – | 541246 | CPX-GE-EV-Z-7/8-5POL |
| | | 5-pin | For ATEX environment | 8022173 | CPX-GE-EV-Z-7/8-5POL-VL |
| | 7/8" connection, metal interlinking block | 5-pin | – | 550210 | CPX-M-GE-EV-Z-7/8-5POL |
| 5-pin | | For ATEX environment | 8022158 | CPX-M-GE-EV-Z-7/8-5POL-VL | |
|  | Push-pull plug connection (AIDA), metal interlinking block | 5-pin | – | 563058 | CPX-M-GE-EV-Z-PP-5POL |
| Connection sockets 7/8" | | | | | |
|  | Power supply socket | 5-pin | | 543107 | NECU-G78G5-C2 |
| | | 4-pin | | 543108 | NECU-G78G4-C2 |
|  | Angled socket, 5-pin – open cable end, 5-wire | 2 m | | 573855 | NEBU-G78W5-K-2-N-LE5 |
| M18 connection sockets | | | | | |
|  | Straight socket, screw terminal | 4-pin | PG9 | 18493 | NTSD-GD-9 |
| | | | PG13.5 | 18526 | NTSD-GD-13.5 |
|  | Angled socket, screw terminal | 4-pin | PG9 | 18527 | NTSD-WD-9 |
| | Angled socket, screw terminal | 4-pin | PG11 | 533119 | NTSD-WD-11 |
| Push-pull power supply socket | | | | | |
|  | Socket, spring-loaded terminal, plug pattern PP, fulfils requirements to AIDA | 5-pin | | 5195383 | NECU-M-PPG5PP-C1-PN |
| Mounting accessories | | | | | |
|  | Screws for mounting the bus node/connection block on the plastic interlinking block | Bus node/metal connection block | | 550218 | CPX-DPT-30X32-S-4X |
| | | Bus node/plastic connection block | | 550219 | CPX-M-M3x22-4x |
| | | Bus node/metal connection block | | 550216 | CPX-M-M3x22-S-4x |

Data sheet – Interlinking block with additional supply for valves

Function

Interlinking blocks ensure the electrical supply of all other CPX modules. They have contact rails, from which the other CPX components on the interlinking modules are supplied with power. Internal division of the power supply makes it possible to switch off specific areas of the sensors and actuators individually.

Area of application



- 24 V DC supply voltage for valves



| General technical data | | CPX-GE-EV-V | CPX-GE-EV-VL | CPX-GE-EV-V-7/8-4POL |
|--|--------|-------------------------------|--------------|----------------------|
| Type | | M18 | | 7/8", 4-pin |
| Electrical connection | | M18 | | 7/8", 4-pin |
| Nominal operating voltage | [V DC] | 24 | | |
| Acceptable current load (per contact/contact rail) | [A] | 16 | 8 | 10 |
| Degree of protection to EN 60529 | | Depending on connection block | | |
| Ambient temperature | [°C] | -5 ... +50 | | |
| Note on materials | | RoHS-compliant | | |
| Materials | | PA-reinforced | | |
| PWIS conformity | | VDMA24364-B2-L | | |
| Grid dimension | [mm] | 50 | | |
| Dimensions W x L x H | [mm] | 50 x 107 x 35 | | |
| Product weight | [g] | 125 | | |

| Pin allocation – Plastic interlinking blocks | | Pin | Allocation | | | | | | | | | | | | | | | |
|--|--|------|---|----|------|-------------|--|---|----|---|----|------|-----|----|----|--|--|--|
| Round plug, 4-pin | | | | | | | | | | | | | | | | | | |
| | M18 | | <table border="1"> <tr><td>1</td><td>n.c.</td></tr> <tr><td>2</td><td>24 V DC load voltage supply for valves</td></tr> <tr><td>3</td><td>0V</td></tr> <tr><td>4</td><td>FE</td></tr> </table> | 1 | n.c. | 2 | 24 V DC load voltage supply for valves | 3 | 0V | 4 | FE | | | | | | | |
| | 1 | n.c. | | | | | | | | | | | | | | | | |
| 2 | 24 V DC load voltage supply for valves | | | | | | | | | | | | | | | | | |
| 3 | 0V | | | | | | | | | | | | | | | | | |
| 4 | FE | | | | | | | | | | | | | | | | | |
| | 7/8" | | <table border="1"> <tr><td>A</td><td>n.c.</td></tr> <tr><td>B</td><td>24 V DC load voltage supply for valves</td></tr> <tr><td>C</td><td>FE</td></tr> <tr><td>D</td><td>0V</td></tr> </table> | A | n.c. | B | 24 V DC load voltage supply for valves | C | FE | D | 0V | | | | | | | |
| A | n.c. | | | | | | | | | | | | | | | | | |
| B | 24 V DC load voltage supply for valves | | | | | | | | | | | | | | | | | |
| C | FE | | | | | | | | | | | | | | | | | |
| D | 0V | | | | | | | | | | | | | | | | | |
| <table border="1"> <tr><td>M18</td><td>1</td><td>2</td><td>3</td><td>4</td></tr> <tr><td>7/8"</td><td>A</td><td>B</td><td>D</td><td>C</td></tr> <tr><td></td><td>n.c.</td><td>24V</td><td>0V</td><td>FE</td></tr> </table> | M18 | 1 | 2 | 3 | 4 | 7/8" | A | B | D | C | | n.c. | 24V | 0V | FE | | | |
| M18 | 1 | 2 | 3 | 4 | | | | | | | | | | | | | | |
| 7/8" | A | B | D | C | | | | | | | | | | | | | | |
| | n.c. | 24V | 0V | FE | | | | | | | | | | | | | | |

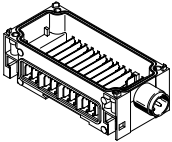
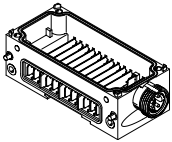
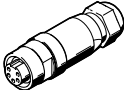
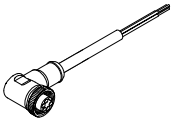
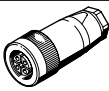
Data sheet – Interlinking block with additional supply for valves

| Ordering data | | | | Part no. | Type |
|--|---|---------------------------------|----------------------|----------|----------------------|
| Designation | | | | | |
| Interlinking block with additional supply for valves | | | | | |
|  | M18 connection, plastic interlinking block | 4-pin | – | 533577 | CPX-GE-EV-V |
| | | | For ATEX environment | 8022171 | CPX-GE-EV-V-VL |
|  | 7/8" connection, plastic interlinking block | 4-pin | – | 541252 | CPX-GE-EV-V-7/8-4POL |
| Connection sockets 7/8" | | | | | |
|  | Power supply socket | 4-pin | | 543108 | NECU-G78G4-C2 |
|  | Angled socket, 5-pin – open cable end, 5-wire | 2 m | | 573855 | NEBU-G78W5-K-2-N-LE5 |
| M18 connection sockets | | | | | |
|  | Straight socket, screw terminal | 4-pin | PG9 | 18493 | NTSD-GD-9 |
| | | 4-pin | PG13.5 | 18526 | NTSD-GD-13.5 |
|  | Angled socket, screw terminal | 4-pin | PG9 | 18527 | NTSD-WD-9 |
| | Angled socket, screw terminal | 4-pin | PG11 | 533119 | NTSD-WD-11 |
| Mounting accessories | | | | | |
|  | Screws for mounting the bus node/connection block on the plastic interlinking block | Bus node/metal connection block | | 550218 | CPX-DPT-30X32-S-4X |

Data sheet – Interlinking block with system forwarding

Function

Interlinking blocks ensure the electrical supply of all other CPX modules. They have contact rails, from which the other CPX components on the interlinking modules are supplied with power. Internal division of the power supply makes it possible to switch off specific areas of the sensors and actuators individually.

Area of application

- Forwarding of 24 V DC supply voltage for the electronics of the CPX terminal
- Forwarding of 24 V DC supply voltage for inputs
- Forwarding of 24 V DC supply voltage for valves
- Forwarding of 24 V DC supply voltage for outputs



| General technical data | | |
|----------------------------------|--------|-------------------------------|
| Nominal operating voltage | [V DC] | 24 |
| Degree of protection to EN 60529 | | Depending on connection block |
| Ambient temperature | [°C] | -5 ... +50 |
| Note on materials | | RoHS-compliant |
| PWIS conformity | | VDMA24364-B2-L |
| Grid dimension | [mm] | 50 |
| Dimensions W x L x H | [mm] | 50 x 107 x 35 |

| Technical data – Metal interlinking blocks | | | |
|--|-------------------------|-----|---------|
| Type | CPX-M-GE-EV-W-M12-5POL | | |
| Electrical connection | Socket | | |
| | M12x1 | | |
| | 5-pin | | |
| | L-coded | | |
| Power supply | Sensors and electronics | [A] | Max. 16 |
| | Valves and outputs | [A] | Max. 16 |
| Corrosion resistance class CRC ¹⁾ | 0 | | |
| Type of mounting | Angled fitting | | |
| Materials | Die-cast aluminium | | |
| Certification | c UL - Recognized (OL) | | |
| Product weight | [g] | 266 | |

1) Additional information: www.festo.com/x/topic/kbk

Note

Points to note about the interlinking block CPX-M-GE-EV-W-M12-5POL:

- Must be mounted as the first module to the right or to the left of the system supply
- Only one interlinking block permitted per CPX terminal

Data sheet – Interlinking block with system forwarding

| Pin allocation – Metal interlinking blocks | | Pin | Allocation |
|--|--|-------------------|--|
| Circuitry | | | |
| Round plug, 5-pin | | | |
| | <p>0V Valves 24V Valves 0V Output 24V Output 0V El./Sen. 24V El./Sen. FE</p> | <p>M12</p> | |
| | | 1 | 24 V DC power supply for electronics and sensors |
| 2 | 0 V valves and outputs | | |
| 3 | 0 V electronics and sensors | | |
| 4 | 24 V DC load voltage supply for valves and outputs | | |
| FE | FE | | |

| Ordering data | | Part no. | Type |
|---|--|----------|--------------------------------|
| Designation | | | |
| Interlinking block with system forwarding | | | |
| | M12x1 L-coded connection, metal interlinking block | 5-pin | 8098391 CPX-M-GE-EV-W-M12-5POL |
| Power supply plugs M12 | | | |
| | Straight plug, screw terminal | 5-pin | 8166791 NECL-S-L12G5-C2-Q10 |
| | Angled plug, screw terminal | 5-pin | 8166792 NECL-S-L12W5-C2-Q10 |

Data sheet – Pneumatic interface for valve terminal MPA-S

Function

The pneumatic interface VMPA-FB establishes the electromechanical connection between the CPX terminal and the valve terminal MPA-S.

The signals from the bus node are forwarded to the control electronics in the electrical modules of the valve terminal MPA-S via the integrated CPX bus. The bus signal for activating the solenoid coils is converted in the electronics module for max. 8 coils.

From a technical point of view, the individual MPA pneumatic modules each represent a separate electrical module with digital outputs. Valves, which are galvanically isolated, can be supplied with power via the interlinking block CPX-GE-EV-V.

Area of application

- Interface to the valve terminal MPA-S
- Max. 128 solenoid coils
- Characteristics of the electronics module of the valve terminal MPA-S can be parameterised; for example, status of the solenoid coils in the event of fieldbus communication being interrupted (fail-safe), individual channel diagnostics can be activated, condition monitoring can be activated individually for each valve
- The pneumatic interface receives the voltage for the electronics and the supply voltage for the valves from the left-hand interlinking block and feeds them through to the electronics modules of the valve terminal MPA-S
- Electronics modules of the valve terminal MPA-S:
 - Undervoltage of valves
 - Short circuit of valves
 - Open load of valves
 - Counter preset reached in condition monitoring



| General technical data | | VMPA-FB-EPL-G | VMPA-FB-EPL-E |
|-----------------------------------|-------|-----------------------------------|---------------|
| Type | | | |
| Valve terminal design | | Modular, valve sizes can be mixed | |
| Maximum number of valve positions | | 64 | |
| Maximum number of pressure zones | | 17 | |
| Signal status indication | | LED | |
| Pilot air supply | | Internal | External |
| Operating pressure | [MPa] | 0.3 ... 0.8 | -0.09 ... 1 |
| | [bar] | 3 ... 8 | -0.9 ... 10 |
| Pilot pressure | [MPa] | 0.3 ... 0.8 | 0.3 ... 0.8 |
| | [bar] | 3 ... 8 | 3 ... 8 |
| Product weight | [g] | 320 | |
| Degree of protection | | IP67 | |

| Technical data – Electrics | | |
|----------------------------------|--------|-----|
| Nominal operating voltage | [V DC] | 24 |
| Permissible voltage fluctuations | [%] | ±25 |

| Materials | |
|------------------------|-------------------|
| Note on materials | RoHS-compliant |
| LABS (PWIS) conformity | VDMA24364-B1/B2-L |

Accessories – Pneumatic interface for valve terminal MPA-S

| Operating and environmental conditions | |
|--|--|
| Operating medium | Compressed air to ISO 8573-1:2010 [7:4:4] |
| Note on the operating/pilot medium | Lubricated operation possible (in which case lubricated operation will always be required) |
| Ambient temperature | [°C] -5 ... +50 |
| Temperature of medium | [°C] -5 ... +50 |
| Storage temperature | [°C] -20 ... +40 |
| Relative humidity | Max. 90% at 40°C |
| Corrosion resistance class CRC ¹⁾ | 1 |
| CE marking (see declaration of conformity) | To EU EMC Directive ²⁾ |
| | To EU RoHS Directive |
| | To EU Explosion Protection Directive (ATEX) |
| UKCA marking (see declaration of conformity) | To UK EMC regulations |
| | To UK RoHS regulations |
| | To UK regulations for explosions |
| KC marking | KC EMC |
| Certification | RCM compliance mark |
| | c UL us - Recognized (OL) |
| Certificate-issuing authority | DNV 15.0193 X |

1) More information www.festo.com/x/topic/crc

2) For information about the area of use, see the EC declaration of conformity at: www.festo.com/catalogue/... → Support/Downloads.

If the devices are subject to usage restrictions in residential, commercial or light-industrial environments, further measures for the reduction of the emitted interference may be necessary.

| ATEX | |
|---|--------------------|
| ATEX category for gas | II 3G |
| Type of (ignition) protection for gas | Ex ec IIC T4 Gc X |
| Explosion ambient temperature | [°C] -5 ≤ Ta ≤ +50 |
| Explosion protection certification outside the EU | EPL Db (GB) |
| | EPL Gb (GB) |

Overview – Pneumatic interface VMPA-FB

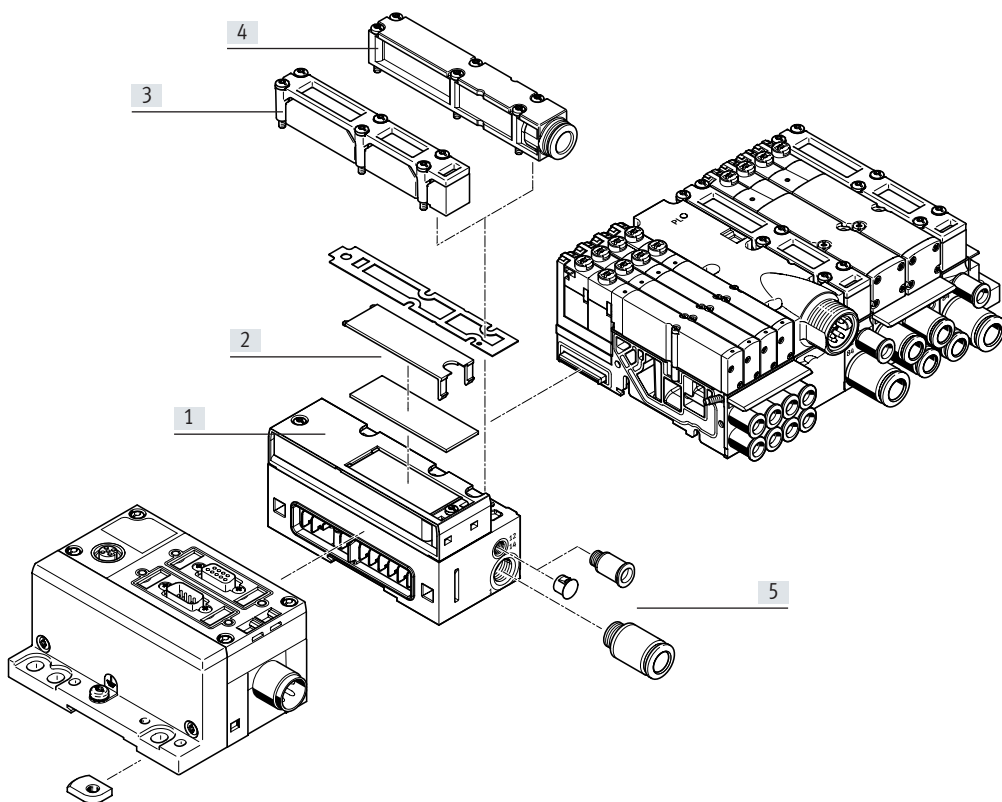

- [1] Pneumatic interface VMPA-FB
- [2] Inscription label
- [3] Flat plate silencer
- [4] Exhaust plate for ducted exhaust air
- [5] Fittings

Accessories – Pneumatic interface for valve terminal MPA-S

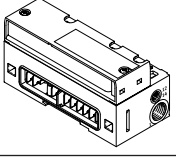
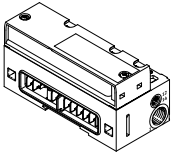
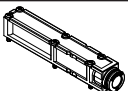
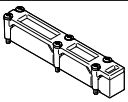
| Ordering data | | Part no. | Type |
|---|--|----------|-----------------|
| Designation | | | |
| Pneumatic interface for CPX plastic interlinking module | | | |
|  | Ducted exhaust air, internal pilot air | 533370 | VMPA-FB-EPL-G |
| | Ducted exhaust air, external pilot air | 533369 | VMPA-FB-EPL-E |
| | Flat plate silencer, internal pilot air | 533372 | VMPA-FB-EPL-GU |
| | Flat plate silencer, external pilot air | 533371 | VMPA-FB-EPL-EU |
| Pneumatic interface for CPX metal interlinking module | | | |
|  | Ducted exhaust air, internal pilot air | 552286 | VMPA-FB-EPLM-G |
| | Ducted exhaust air, external pilot air | 552285 | VMPA-FB-EPLM-E |
| | Flat plate silencer, internal pilot air | 552288 | VMPA-FB-EPLM-GU |
| | Flat plate silencer, external pilot air | 552287 | VMPA-FB-EPLM-EU |
| Exhaust plate | | | |
|  | For ducted exhaust air, with 10 mm push-in connector | 533375 | VMPA-AP |
| | For ducted exhaust air, with QS-3/8 connector | 541629 | VMPA-AP-3/8 |
|  | Flat plate silencer | 533374 | VMPA-APU |

Data sheet – Pneumatic interface for valve terminal MPA-L

Function

The pneumatic interface VMPAL establishes the electromechanical connection between the terminal CPX and the valve terminal MPA-L.

The bus signal for actuating the solenoid coils is converted in the pneumatic interface for the entire valve terminal.

The interlinking within the valve terminal is identical with the interlinking with multi-pin plug connections.

Area of application

- Actuation of the valve terminal MPA-L
- Max. 32 solenoid coils
- The pneumatic interface receives the voltage for the electronics and the supply voltage for the valves from the left-hand interlinking block and feeds them through to the electrical modules of the valve terminal MPA-L



| General technical data | | |
|----------------------------------|--------|-------------------|
| Type | | VMPAL-EPL-CPX |
| Number of solenoid coils | | 32 |
| Operating pressure | [bar] | -0.9 ... 10 |
| Pilot pressure | [bar] | 3 ... 8 |
| Nominal operating voltage | [V DC] | 24 |
| Degree of protection to EN 60529 | | IP67 |
| Ambient temperature | [°C] | -5 ... +50 |
| Note on materials | | RoHS-compliant |
| PWIS conformity | | VDMA24364-B1/B2-L |

Data sheet – Pneumatic interface for valve terminal MPA-L

Overview – Pneumatic interface VMPAL

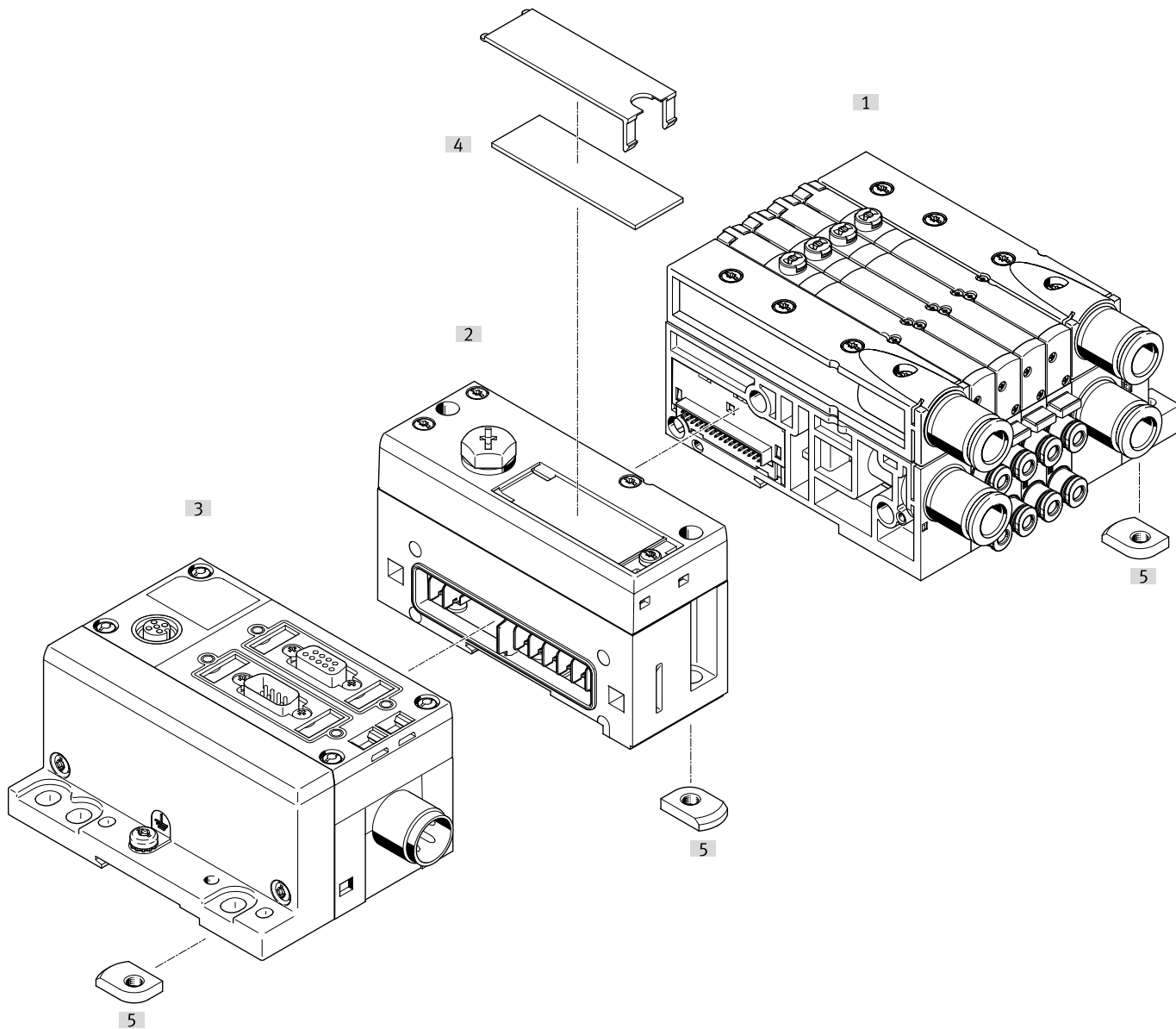

[1] Valve terminal MPA-L
[2] Pneumatic interface VMPAL

[3] Terminal CPX

[4] Inscription label

[5] Mounting for H-rail

Ordering data

Designation

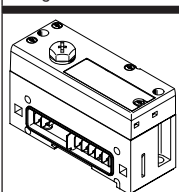

Pneumatic interface for CPX plastic interlinking module

Part no.

570783

Type

VMPAL-EPL-CPX

Data sheet – Pneumatic interface for valve terminal VTSA/VTSA-F

Function

The pneumatic interface VTSA provides the electromechanical connection between the terminal CPX and valve terminal VTSA/VTSA-F.

A complete pneumatic control loop system (FB-valve-drive-sensor-FB) can therefore be connected to the fieldbus using the input modules of the CPX terminal.

Different circuits for valves and electrical outputs are implemented using an additional supply. The integrated valve diagnostics enable the causes of errors to be found quickly, increasing system availability.

Area of application

- Interface to the valve terminal VTSA and VTSA-F
- Max. 32 solenoid coils
- Address space allocation (configuration) of valve terminals can be set using integrated DIL switches
- Properties of the pneumatic interface can be parameterised, e.g. status of the solenoid coil in the event of fieldbus communication being interrupted (fail-safe)
- The pneumatic interface receives the voltage for the electronics and the supply voltage for the valves from the left-hand interlinking block
- Detection of missing solenoid coils and short circuit monitoring for the valves



| General technical data | | | |
|--|-------------|--------|--|
| Max. no. of valve positions | | | 16 with double solenoid valves 32 with single solenoid valves |
| Valve terminal interface | | | Type 44, VTSA |
| Electrical control | | | Fieldbus |
| Electrical connection | | | Via CPX |
| Diagnostics | | | Undervoltage of valves |
| Parameterisation | | | Failsafe per channel |
| | | | Forcing per channel |
| | | | Idle mode per channel |
| | | | Module monitoring |
| LED displays | | | 1 group diagnostics |
| | | | Channel status on valves |
| Fuse protection (short circuit) | | | Internal electronic fuse per valve output |
| Galvanic isolation channel – internal bus | | | Yes, when using an additional supply for the valves |
| Nominal operating voltage | | [V DC] | 24 |
| Operating voltage range | | [V DC] | 21.6 ... 26.4 |
| Intrinsic current consumption at nominal operating voltage | Electronics | [mA] | Typically 15 |
| | Valves | [mA] | Typically 50 |
| Max. power supply per channel | | [A] | 0.2 |
| Max. residual current per module | | [A] | 4 |
| Degree of protection | | | IP65 |
| | | | NEMA 4 |
| Product weight | | [g] | 590 |

Data sheet – Pneumatic interface for valve terminal VTSA/VTSA-F

| Materials | |
|-------------------|--------------------|
| Housing | Die-cast aluminium |
| Cover | PA |
| Note on materials | RoHS-compliant |
| PWIS conformity | VDMA24364-B1/B2-L |

| Operating and environmental conditions | | |
|--|------|------------|
| Ambient temperature | [°C] | -5 ... +50 |
| Corrosion resistance class CRC ¹⁾ | | 0 |

1) Additional information: www.festo.com/x/topic/kbk

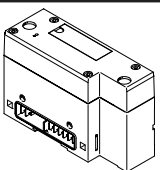
| Ordering data | | | | |
|---|--------------------------------|------------------------------------|---------------------|-----------------------|
| Designation | | Part no. | Type | |
|  | For plastic interlinking block | 543416 | VABA-S6-1-X1 | |
| | For metal interlinking block | Diagnostics via fieldbus | 550663 | VABA-S6-1-X2 |
| | | Diagnostics via process data image | 573613 | VABA-S6-1-X2-D |

Data sheet – Pneumatic interface for valve terminal VTSA-F-CB

Function

The pneumatic interface provides the electromechanical connection between the terminal CPX and valve terminal VTSA-F-CB.

A complete pneumatic control loop system (FB-valve-drive-sensor-FB) can therefore be connected to the fieldbus using the input modules of the CPX terminal.

Different circuits for valves and electrical outputs are implemented using an additional supply. The integrated valve diagnostics enable the causes of errors to be found quickly, increasing system availability.

Area of application

- Interface to valve terminal VTSA-F-CB
- Max. 24 solenoid coils
- Properties of the pneumatic interface can be parameterised, e.g. status of the solenoid coil in the event of fieldbus communication being interrupted (fail-safe)
- The pneumatic interface receives the voltage for the electronics and the supply voltage for the valves from the left-hand interlinking block
- The supply voltage for the valves is provided from the left-hand interlinking block or externally
- Detection of missing solenoid coils and short circuit monitoring for the valves

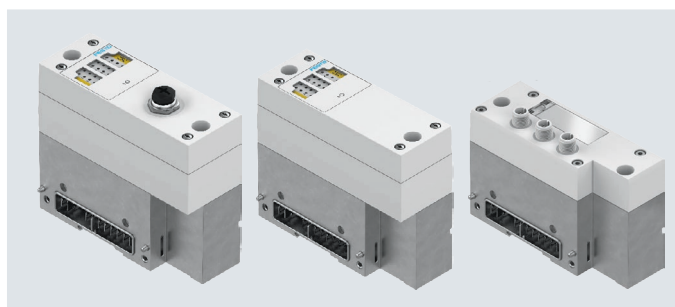

| General technical data | | Pneumatic interface | | |
|---|-----------------------|--|----------------------------------|--|
| | | Without voltage zones | With safe voltage zones | With external power supply to the valves |
| Max. no. of valve positions | | 12 with double solenoid valves 24 with single solenoid valves | | |
| Valve terminal interface | | Type 44, VTSA | | |
| Electrical control | | Fieldbus | | |
| Electrical connection | | Via CPX | | |
| Electrical connection output | Function | – | Safe digital output | – |
| | Connection type | – | Socket | – |
| | Connection technology | – | M12x1, A-coded to EN 61076-2-101 | – |
| | Number of pins/wires | – | 5 | – |
| Electrical connection, power supply to valves | Function | – | – | – |
| | Connection type | – | – | Plug |
| | Connection technology | – | – | 3x M12x1, A-coded |
| | Number of pins/wires | – | – | 5 |
| Diagnostics | | Wire break per valve coil | | |
| | | Short circuit of valves | | |
| | | Undervoltage of valves | | |
| Parameterisation | | Failsafe per channel | | |
| | | Forcing per channel | | |
| | | Idle mode per channel | | |
| | | Module monitoring | | |
| LED displays | | 1 group diagnostics | 1 group diagnostics | 1 group diagnostics |
| | | Channel status on valves | – | Channel status on valves |
| | | – | – | 3 load supply |

Data sheet – Pneumatic interface for valve terminal VTSA-F-CB

| Technical data – Electrics | | Pneumatic interface | | | |
|--|-------------|---|---|--|--------------|
| | | Without voltage zones | With safe voltage zones | With external power supply to the valves | |
| Nominal operating voltage | [V DC] | 24 | | | |
| Operating voltage range | [V DC] | 21.6 ... 26.4 | | | |
| Intrinsic current consumption at nominal operating voltage | Electronics | [mA] | Typically 11 | <ul style="list-style-type: none"> Typically 45 for electronics without CPX-FVDA-P2 Typically 110 for electronics with CPX-FVDA-P2 | Typically 11 |
| | Valves | [mA] | Typically 45 | <ul style="list-style-type: none"> Typically 25 for valves without CPX-FVDA-P2 Typically 90 for valves with CPX-FVDA-P2 | Typically 45 |
| Max. power supply per channel | [A] | 0.2 | 0.2 | 0.2 | |
| Max. residual current per module | [A] | 6 | 4.5 | 6 | |
| Fuse protection (short circuit) | | Internal electronic fuse per valve output | Internal electronic fuse per valve output | Internal electronic fuse per valve output | |
| Galvanic isolation channel – internal bus | | Yes, when using an additional supply for the valves | Yes, when using an additional supply for the valves | Yes | |

| Materials | | Pneumatic interface | | |
|-------------------|--|-----------------------|-------------------------|--|
| | | Without voltage zones | With safe voltage zones | With external power supply to the valves |
| Housing | | Die-cast aluminium | – | Die-cast aluminium |
| Cover | | PA | PA | PA |
| Sub-base | | – | Die-cast aluminium | – |
| Seals | | – | NBR | – |
| Screws | | – | Steel | – |
| Note on materials | | RoHS-compliant | RoHS-compliant | RoHS-compliant |
| PWIS conformity | | VDMA24364-B1/B2-L | VDMA24364-B1/B2-L | VDMA24364-B1/B2-L |

| Operating and environmental conditions | | Pneumatic interface | | |
|--|------|-----------------------|--|--|
| | | Without voltage zones | With safe voltage zones | With external power supply to the valves |
| Ambient temperature | [°C] | –5 ... +50 | –5 ... +50 | –5 ... +50 |
| Storage temperature | [°C] | – | –20 ... +60 | – |
| Corrosion resistance class CRC ¹⁾ | | 0 | 0 | 0 |
| Shock resistance | | – | Shock test with severity level 2 to FN 942017-5 and EN 60068-2-27 | – |
| Vibration resistance | | – | Transport application test with severity level 2 to FN 942017-4 and EN 60068-2-6 | – |
| CE marking (see declaration of conformity) ³⁾ | | – | To EU EMC Directive ²⁾ | – |
| | | – | To EU RoHS Directive | – |
| UKCA marking (see declaration of conformity) ³⁾ | | – | To UK instructions for EMC | – |
| | | – | To UK RoHS instructions | – |
| Degree of protection | | IP65 | IP65 | IP65 |
| | | NEMA 4 | – | NEMA 4 |

1) Additional information: www.festo.com/x/topic/kbk

2) For information about the area of use, see the EC declaration of conformity at: www.festo.com/catalogue/... → Support/Downloads.

If the devices are subject to usage restrictions in residential, commercial or light-industrial environments, further measures for the reduction of the emitted interference may be necessary.

3) Additional information: www.festo.com/catalogue/... → Support/Downloads.

Data sheet – Pneumatic interface for valve terminal VTSA-F-CB

| Combinations of bus nodes/control blocks with pneumatic interface | | | | | |
|---|----------------|---------------------|----------------|-------------------|-------------------|
| Bus node/control block | Part no. | Pneumatic interface | | | |
| | | VABA-...-X1-CB | VABA-...-X2-CB | VABA-...-X2-F1-CB | VABA-...-X2-F2-CB |
| CPX-FB13 | 195740 | ■ | ■ | ■ | ■ |
| CPX-FB36 | 1912451 | ■ | ■ | – | – |
| CPX-FB37 | 2735960 | ■ | ■ | – | – |
| CPX-FB43 | 8110369 | ■ | ■ | ■ | ■ |
| CPX-M-FB44 | 8110370 | ■ | ■ | ■ | ■ |

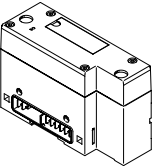
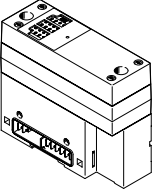
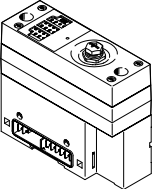
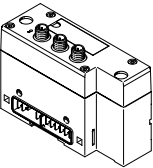
| Ordering data | | | | | |
|--|--------------------------------|--|--------------------|----------------|---------------------------|
| | Description | | Product weight [g] | Part no. | Type |
| Pneumatic interface without voltage zones | | | | | |
|  | For plastic interlinking block | | 560 | 8082877 | VABA-S6-1-X1-CB |
| | For metal interlinking block | | 560 | 8082876 | VABA-S6-1-X2-CB |
| Pneumatic interface with voltage zones | | | | | |
|  | For metal interlinking block | Division of the connected valves into up to 3 safe voltage zones | 734 | 8068240 | VABA-S6-1-X2-F1-CB |
|  | For metal interlinking block | <ul style="list-style-type: none"> • Division of the connected valves into up to 2 safe voltage zones • 1 external safe voltage zone | 754 | 8068241 | VABA-S6-1-X2-F2-CB |
|  | For plastic interlinking block | <ul style="list-style-type: none"> • Division of the connected valves into up to 3 voltage zones • External power supply for each voltage zone | 580 | 8082879 | VABA-S6-1-X1-3V-CB |
| | For metal interlinking block | <ul style="list-style-type: none"> • Division of the connected valves into up to 3 voltage zones • External power supply for each voltage zone | 580 | 8082878 | VABA-S6-1-X2-3V-CB |

Data sheet

Dimensions – Plastic interlinking module

Download CAD data → www.festo.com

With bus nodes and connection blocks

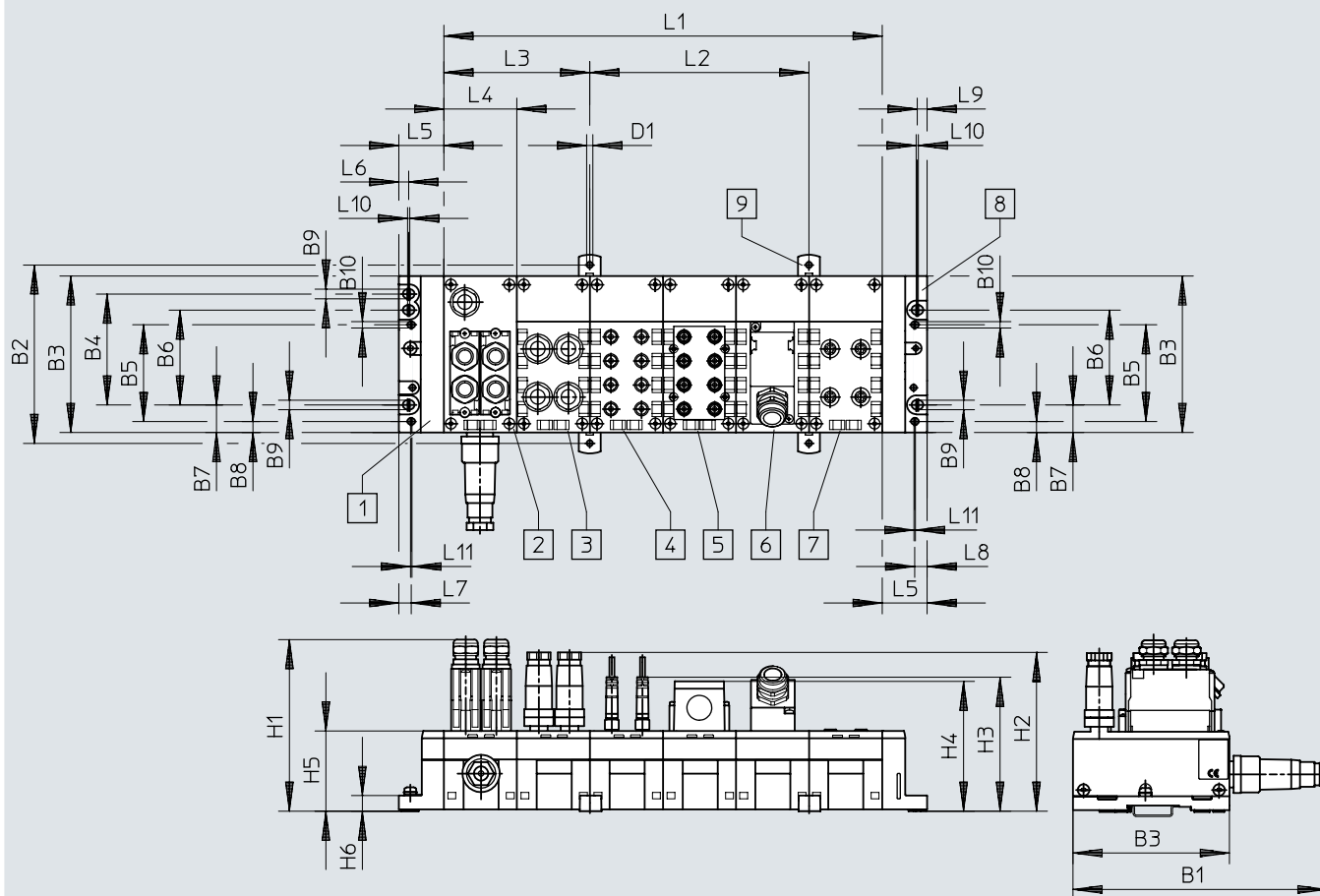

[1] Left-hand end plate (earthing plate optional)

[2] Bus node

[3] Connection block CPX-AB-4-M12-8POL

[4] Connection block CPX-AB-8-M8-3POL

[5] Connection block CPX-AB-8-KL-4POL

[6] Connection block CPX-AB-1-SUB-BU-25POL

[7] Connection block CPX-AB-4-M12-8POL

[8] Right-hand end plate

[9] Mounting clip for wall mounting (required every 2 ... 3 connection blocks)

n Number of CPX modules

| Type | B1 | B2 | B3 | B4 | B5 | B6 | B7 | B8 | B9 | B10 | D1 |
|-------|-----|-------|-------|----|------|----|------|-----|-----|-----|-----|
| CPX-M | 175 | 122.3 | 107.3 | 78 | 66.3 | 65 | 18.9 | 7.5 | 6.6 | 4.4 | 4.3 |

| Type | H1 | H2 | H3 | H4 | H5 | H6 |
|-------|-----|-----|----|------|------|------|
| CPX-M | 118 | 110 | 92 | 89.1 | 55.1 | 10.8 |

| Type | L1 ¹⁾ | L2 | L3 ²⁾ | L4 | L5 ³⁾ | L6 | L7 | L8 | L9 | L10 | L11 |
|-------|------------------|-------|------------------|------|------------------|-----|-----|-----|-----|-----|-----|
| CPX-M | nx50.1 | 150.3 | 100.2 | 50.1 | 30.8 | 7.1 | 8.8 | 8.5 | 6.8 | 1.5 | 1 |

1) n = Number of CPX modules

Data sheet

Dimensions – Metal interlinking block

Download CAD data → www.festo.com

With bus nodes and connection blocks

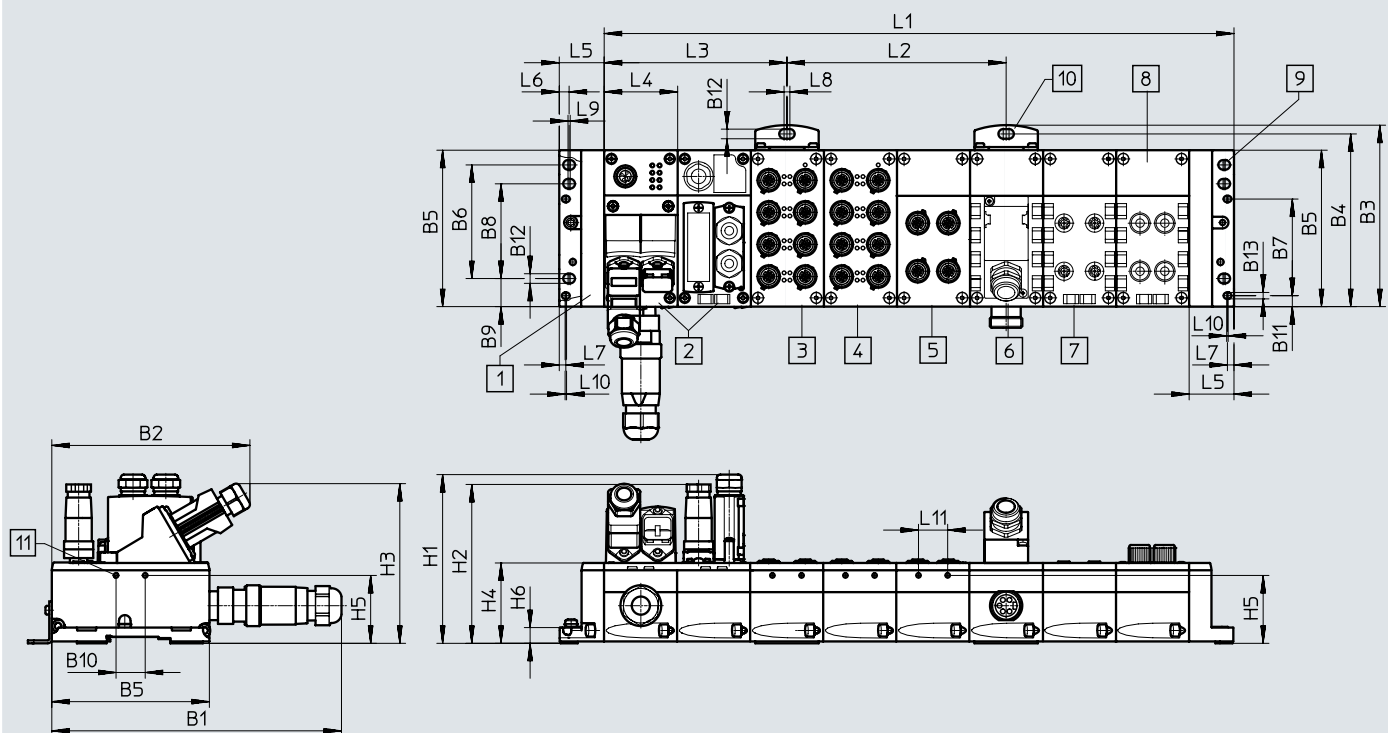

- [1] Left-hand end plate
- [2] Bus node
- [3] Connection block
CPX-M-AB-8-M12X2-5POL
- [4] Connection block
CPX-M-AB-8-M12X2-5POL
- [5] Connection block
CPX-M-AB-4-M12X2-5POL
- [6] Connection block
CPX-AB-1-SUB-BU-25POL
- [7] Connection block
CPX-AB-4-M12-8POL
- [8] Right-hand end plate
- [9] Mounting bracket for wall
mounting
- [10] Hole for self-tapping screw
M2.5

| Type | B1 | B2 | B3 | B4 | B5 | B6 | B7 | B8 | B9 | B10 | B11 | B12 | B13 |
|-------|-----|-----|-------|--------|-------|-------|------|----|-------|-----|-----|-----|-----|
| CPX-M | 199 | 136 | 124.9 | 118.85 | 108.1 | 77.95 | 66.3 | 65 | 19.25 | 20 | 7.9 | 6.6 | 4.4 |

| Type | H1 | H2 | H3 | H4 | H5 | H6 |
|-------|-----|-----|-------|------|-------|------|
| CPX-M | 116 | 109 | 109.5 | 55.1 | 46.55 | 10.8 |

| Type | L1 ¹⁾ | L2 | L3 ²⁾ | L4 | L5 ³⁾ | L6 | L7 | L8 | L9 | L10 | L11 |
|-------|------------------|-------|------------------|------|------------------|------|-----|----|-----|-----|-----|
| CPX-M | nx50.1+30.4 | 150.3 | 125.25 | 50.1 | 30.4 | 6.75 | 4.5 | 4 | 1.5 | 1 | 20 |

1) n = Number of CPX modules

Data sheet

Dimensions

Download CAD data → www.festo.com

With bus node and valve terminal VTSA/VTSA-F/VTSA-F-CB

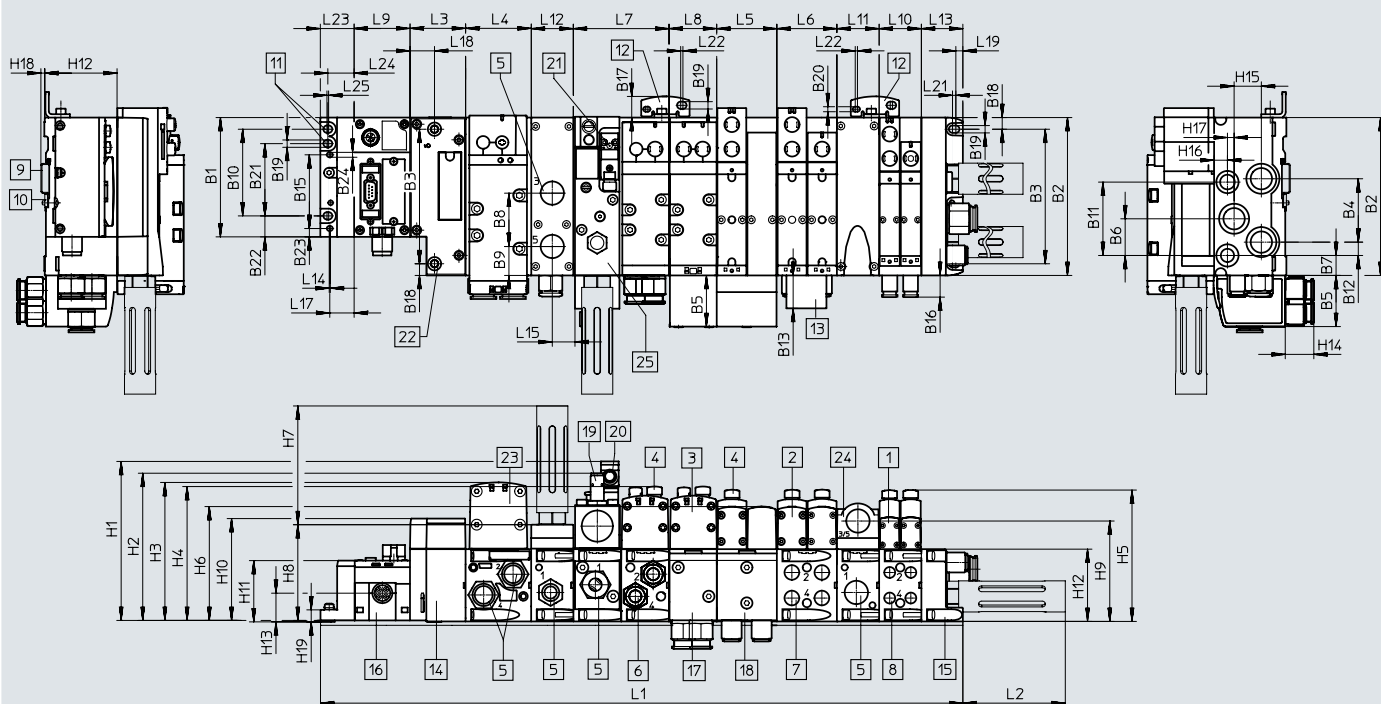

- [1] Solenoid valve, width 18 mm
- [2] Solenoid valve, width 26 mm
- [3] Solenoid valve, width 42 mm
- [4] Cover cap/manual override
- [5] Threaded connection G1/2
- [6] Threaded connection G3/8
- [7] Threaded connection G1/4
- [8] Threaded connection G1/8
- [9] H-rail
- [10] H-rail mounting
- [11] Mounting hole
- [12] Additional mounting bracket
- [13] Inscription label holder
- [14] Pneumatic interface CPX
- [15] End plate
- [16] CPX module/bus node
- [17] 90°-connection plate 43 mm, G3/8
- [18] 90°-connection plate 54 mm, G1/4
- [19] Proximity switch M12x1
- [20] Plug socket M12x1
- [21] Electrical connection to EN 175301-803, type C
- [22] Additional mounting bracket
- [23] Hole for additional mounting, diameter 6.4 2x
- [24] Solenoid valve, width 52 mm
- [25] Supply plate
- [26] Soft-start valve

| Dim. | B1 | B2 | B3 | B4 | B5 | B6 | B7 | B8 | B9 | B10 | B11 | B12 | B13 | B14 | B16 | B18 | B19 | B20 | B21 | B22 | B23 | B24 |
|------|-------|-----|-----|----|----|----|----|----|----|-----|-----|-----|------|-----|------|------|-----|-----|-----|------|-----|-----|
| [mm] | 107.3 | 142 | 121 | 57 | 46 | 33 | 18 | 48 | 26 | 78 | 66 | 12 | 29.6 | 23 | 19.5 | 10.5 | 6.6 | 4.5 | 65 | 18.9 | 7.5 | 4.4 |

| Dim. | L2 | L3 | L4 | L5 | L6 | L7 | L8 | L9 | L10 | L11 | L12 | L13 | L14 | L15 | L17 | L18 | L19 | L20 | L21 | L22 |
|------|------|----|-------|--------|----|-------|----|----------|--------|--------|-----|------|-----|------|-----|-----|-----|-----|-----|-----|
| [mm] | 92.4 | 50 | n2x59 | n01x54 | 54 | n1x43 | 43 | m x 50.1 | n02x38 | n x 38 | 38 | 37.3 | 1 | 20.5 | 22 | 22 | 6.3 | 5.5 | 3 | 2 |

| Dim. | L23 | L24 | L25 | H1 | H2 | H3 | H4 | H5 | H6 | H7 | H8 | H9 | H10 | H11 | H12 | H13 | H14 | H15 | H16 | H17 | H18 | H19 |
|------|------|------|-----|-------|-------|-----|-------|-------|-----|-------|----|------|------|------|-----|------|------|------|-----|-----|-----|------|
| [mm] | 30.4 | 23.7 | 1.5 | 143.9 | 133.3 | 125 | 121.3 | 118.2 | 103 | 106.8 | 87 | 90.3 | 92.9 | 55.1 | 65 | 25.8 | 25.7 | 24.5 | 12 | 6 | 3.5 | 10.8 |

| Width | L1 ¹⁾ |
|--|--|
| 40 mm | 30.4 + m x 50.1 + 50 + n02 x 38 + n x 38 + 37.3 |
| 26 mm | 30.4 + m x 50.1 + 50 + n01 x 54 + n x 38 + 37.3 |
| 42 mm | 30.4 + m x 50.1 + 50 + n1 x 43 + n x 38 + 37.3 |
| 52 mm | 30.4 + m x 50.1 + 50 + n2 x 59 + n x 38 + 37.3 |
| Mixture of 18 mm, 26 mm, 42 mm and 52 mm | 30.4 + m x 50.1 + 50 + n02 x 38 + n01 x 54 + n1 x 43 + n2 x 59 + n x 38 + 37.3 |

- 1) n02 Number of manifold sub-bases 38 mm
- n01 Number of manifold sub-bases 54 mm
- n1 Number of manifold sub-bases 43 mm
- n2 Number of manifold sub-bases 59 mm
- n Number of supply plates (only with end plate with pilot air selector)
- m Number of CPX modules

† Note: This product conforms to ISO 1179-1 and ISO 228-1.

Data sheet

Dimensions

Download CAD data → www.festo.com

With bus node and valve terminal MPA-S

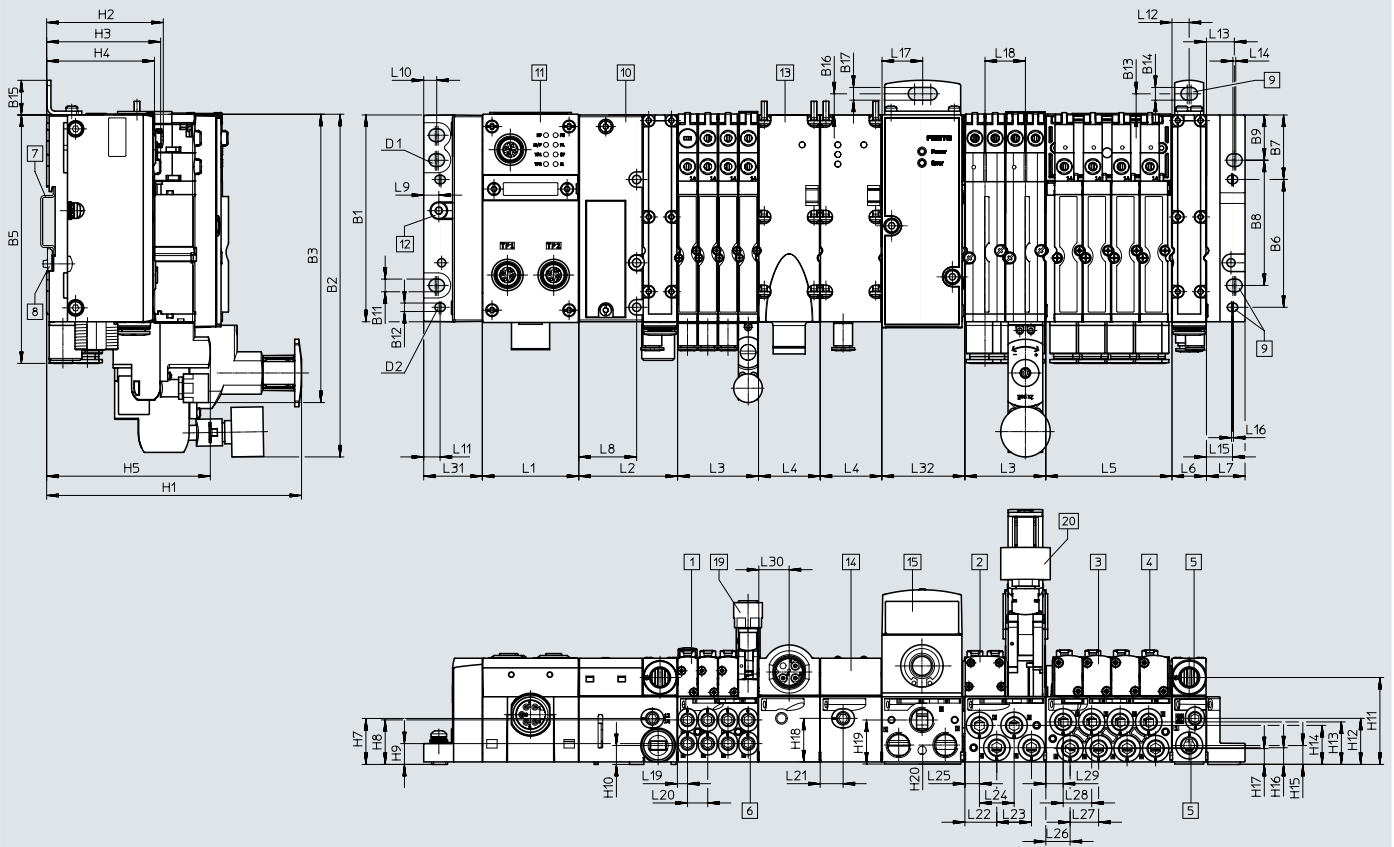

- [1] Solenoid valve
- [2] Working ports
- [3] H-rail
- [4] Pneumatic interface VMPA-FB
- [5] CPX module
- [6] Earthing screw
- [7] Electrical supply plate
- [8] Pressure sensor
- [9] Proportional pressure regulator



| Type | B1 | B2 | B3 | B5 | B6 | B7 | B8 | B9 | B11 | B12 | B13 | B14 | B15 | B17 |
|-------|-------|-----|-------|-----|------|------|----|------|-----|-----|-----|-----|-----|-----|
| MPA-S | 107.3 | 178 | 149.2 | 129 | 66.4 | 33.5 | 65 | 23.5 | 6.6 | 4.4 | 11 | 6.6 | 18 | 6.6 |

| Type | D2 | H1 | H5 | H7 | H11 | H12 | H15 | H21 | L1 ¹⁾ | L2 | L3 ²⁾ | L4 | L5 ³⁾ | L6 |
|-------|----|-------|------|------|------|------|-----|------|------------------|------|------------------|----|------------------|------|
| MPA-S | M4 | 132.3 | 84.9 | 23.9 | 45.1 | 23.9 | 9.8 | 93.4 | m x 50.1 | 51.3 | n x 42 | 32 | o x 65.5 | 17.9 |

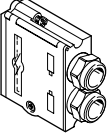

| Type | L7 | L8 | L10 | L12 | L13 | L14 | L15 | L17 | L21 | L30 | L31 | L32 | L33 |
|-------|----|----|-----|-----|------|-----|------|-----|------|------|------|-----|-----|
| MPA-S | 20 | 30 | 6.8 | 9 | 14.5 | 1.5 | 13.5 | 21 | 11.9 | 15.8 | 30.4 | 42 | 27 |

1) m = Number of CPX modules
 2) n = number of sub-bases with 4 valve positions (width 10 mm) or 2 valve positions (width 20 mm)
 3) o = number of sub-bases with 4 valve positions (width 14 mm)

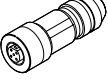
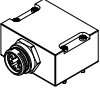
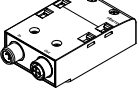
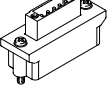
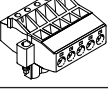
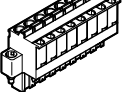
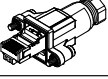
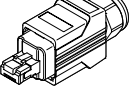
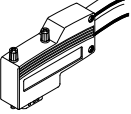
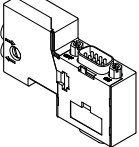



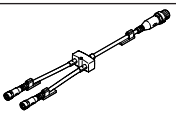

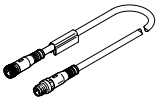
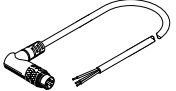
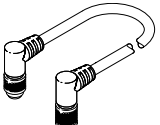
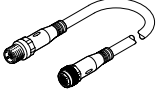
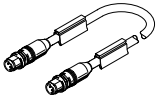
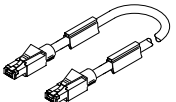

Accessories

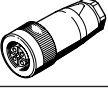
| Ordering data – Accessories | | | | Part no. | Type |
|--|---|----------------|---|----------|-----------------------|
| Designation | | | | | |
| Connectors and accessories | | | | | |
|  | Sub-D plug for INTERBUS | | Incoming | 532218 | FBS-SUB-9-BU-IB-B |
| | | | Outgoing | 532217 | FBS-SUB-9-GS-IB-B |
| | Sub-D plug for DeviceNet/CANopen | | | 532219 | FBS-SUB-9-BU-2x5POL-B |
| | Sub-D plug for PROFIBUS DP | | | 532216 | FBS-SUB-9-GS-DP-B |
| | Sub-D plug for CC-Link | | | 532220 | FBS-SUB-9-GS-2x4POL-B |
|  | Sub-D plug | | | 534497 | FBS-SUB-9-GS-1x9POL-B |
| | Bus connection M12 adapter (B-coded) for PROFIBUS DP | | | 533118 | FBA-2-M12-5POL-RK |
| | Micro style bus connection, 2xM12 for DeviceNet/CANopen | | | 525632 | FBA-2-M12-5POL |
|  | For micro style connection, M12 | | Socket | 18324 | FBSD-GD-9-5POL |
| | | | Plug | 175380 | FBS-M12-5GS-PG9 |
| | M12x1 bus connection, 4-pin (D-coded) for Ethernet | | | 543109 | NECU-M-S-D12G4-C2-ET |
| | For FBA-2-M12-5POL-RK and CPX-AB-2-M12-RK-DP, M12x1, 5-pin, straight | | Socket | 1067905 | NECU-M-B12G5-C2-PB |
| | | | Plug | 1066354 | NECU-M-S-B12G5-C2-PB |
| | Plug M12x1, 4-pin, straight, A-coded | Screw terminal | Connection cross section 0.14 ... 0.5 mm ² | | 192008 |
| Permissible cable ø 4 ... 6 mm | | | 18666 | SEA-GS-7 | |
| Permissible cable ø 6 ... 8 mm | | | 18778 | SEA-GS-9 | |
|  | Connection block, 9-pin Sub-D socket, 5-pin 7/8" plug for DeviceNet | | | 571052 | CPX-AB-1-7/8-DN |
|  | Connection block M12 adapter (B-coded) | | For PROFIBUS DP | 541519 | CPX-AB-2-M12-RK-DP |
|  | Open style bus connection for 5-pin terminal strip for DeviceNet/CANopen | | | 525634 | FBA-1-SL-5POL |
|  | Terminal strip for open style connection, 5-pin | | | 525635 | FBSD-KL-2x5POL |
|  | 8-pin socket | | Spring-loaded terminal | 565712 | NECU-L3G8-C1 |
| | | | Screw terminal | 565710 | NECU-L3G8-C2 |
|  | RJ45/plug | | | 534494 | FBS-RJ45-8-GS |
|  | RJ45 plug, 8-pin, push-pull | | | 552000 | FBS-RJ45-PP-GS |
| | Plug SCRJ, 2-pin, push-pull, for CPX-M-FB45 | | | 571017 | FBS-SCRJ-PP-GS |
|  | Plug for CAN bus interface, electric axes Sub-D, 9-pin, without terminating resistor | | | 533783 | FBS-SUB-9-WS-CO-K |
|  | Sub-D socket with terminating resistor and programming interface | | For CANopen | 574588 | NECU-S1W9-C2-ACO |
| | Sub-D plug, straight, with terminating resistor and programming interface | | For PROFIBUS | 574589 | NECU-S1W9-C2-APB |

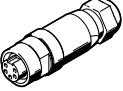
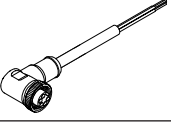

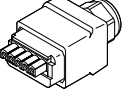

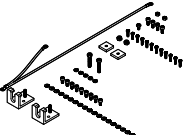
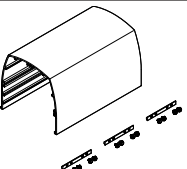
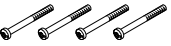

Accessories

| Ordering data – Accessories | | | | Part no. | Type | |
|---|--|---|----------------------------|----------|------------------------------|-----------------------------|
| Designation | | | | | | |
| Distributor | | | | | | |
|  | Modular system for all types of sensor/actuator distributor | | | – | NEDY-... → Internet: nedy | |
|  | Push-in T-connector | 1x plug M8, 4-pin | 2x socket M8, 3-pin | 8005312 | NEDY-L2R1-V1-M8G3-N-M8G4 | |
| | | 1x plug M12, 4-pin | 2x socket M8, 3-pin | 8005311 | NEDY-L2R1-V1-M8G3-N-M12G4 | |
| | | | 2x socket M12, 5-pin | 8005310 | NEDY-L2R1-V1-M12G5-N-M12G4 | |
| Connecting cables | | | | | | |
|  | Modular system for a choice of connecting cables | | | – | NEBU-... → Internet: nebu | |
| | Connecting cable M8-M8, straight plug/straight socket | | 0.5 m | 541346 | NEBU-M8G3-K-0.5-M8G3 | |
| | | | 1.0 m | 541347 | NEBU-M8G3-K-1-M8G3 | |
| | | | 2.5 m | 541348 | NEBU-M8G3-K-2.5-M8G3 | |
| | | | 5.0 m | 541349 | NEBU-M8G3-K-5-M8G3 | |
| | Connecting cable M12-M12, 5-pin, straight plug/straight socket | | 1.5 m | 529044 | KV-M12-M12-1.5 | |
| | | | 3.5 m | 530901 | KV-M12-M12-3.5 | |
| | Connecting cable for CPX-CTEL, M12-M12, 5-pin, straight plug/straight socket | | 5 m | 574321 | NEBU-M12G5-E-5-Q8N-M12G5 | |
| | | | 7.5 m | 574322 | NEBU-M12G5-E-7.5-Q8N-M12G5 | |
| | | | 10 m | 574323 | NEBU-M12G5-E-10-Q8N-M12G5 | |
| | Connecting cable M12-M12, 8-pin, straight plug/straight socket | | 2.0 m | 525617 | KM12-8GD8GS-2-PU | |
| | | | | | | |
|  | Connecting cable M9, 5-pin, angled plug/open cable end 3-pin | | 2 m | 563711 | NEBC-M9W5-K-2-N-LE3 | |
| | | | 5 m | 563712 | NEBC-M9W5-K-5-N-LE3 | |
|  | Connecting cable M9, angled plug/angled socket | | 0.25 m | 540327 | KVI-CP-3-WS-WD-0.25 | |
| | | | 0.5 m | 540328 | KVI-CP-3-WS-WD-0.5 | |
| | | | 2 m | 540329 | KVI-CP-3-WS-WD-2 | |
| | | | 5 m | 540330 | KVI-CP-3-WS-WD-5 | |
| | | | 8 m | 540331 | KVI-CP-3-WS-WD-8 | |
|  | Connecting cable M9, Straight plug/straight socket | | 2 m | 540332 | KVI-CP-3-GS-GD-2 | |
| | | | 5 m | 540333 | KVI-CP-3-GS-GD-5 | |
| | | | 8 m | 540334 | KVI-CP-3-GS-GD-8 | |
|  | Connecting cable, straight plug, M12x1, 4-pin, D-coded | Straight plug, M12x1, 4-pin, D-coded | 0.5 m | 8040446 | NEBC-D12G4-ES-0.5-S-D12G4-ET | |
| | | | | 1 m | 8040447 | NEBC-D12G4-ES-1-S-D12G4-ET |
| | | | | 3 m | 8040448 | NEBC-D12G4-ES-3-S-D12G4-ET |
| | | | | 5 m | 8040449 | NEBC-D12G4-ES-5-S-D12G4-ET |
| | | | | 10 m | 8040450 | NEBC-D12G4-ES-10-S-D12G4-ET |
| | | | Straight plug, RJ45, 8-pin | 1 m | 8040451 | NEBC-D12G4-ES-1-S-R3G4-ET |
| | | | | 3 m | 8040452 | NEBC-D12G4-ES-3-S-R3G4-ET |
| | | | | 5 m | 8040453 | NEBC-D12G4-ES-5-S-R3G4-ET |
| | | | Open end, 4-wire | 10 m | 8040454 | NEBC-D12G4-ES-10-S-R3G4-ET |
| | | | | 5 m | 8040456 | NEBC-LE4-ES-5-D12G4-ET |
|  | Connecting cable, Straight plug, RJ45, 8-pin | | 1 m | 8040455 | NEBC-R3G4-ES-1-S-R3G4-ET | |

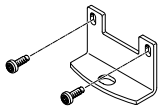
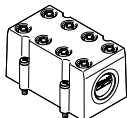
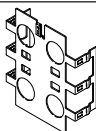
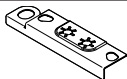
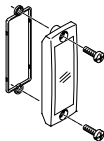
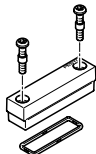

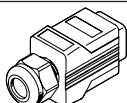
Accessories

| Ordering data – Accessories | | Part no. | Type |
|--|---|-----------------------------------|------------------------------------|
| Designation | | | |
| Connectors and accessories – Power supply | | | |
|  | Plug socket for mains connection M18, straight | For 1.5 mm ² | 18493 NTSD-GD-9 |
| | | For 2.5 mm ² | 18526 NTSD-GD-13.5 |
|  | Plug socket for mains connection M18, angled | For 1.5 mm ² | 18527 NTSD-WD-9 |
| | | For 2.5 mm ² | 533119 NTSD-WD-11 |
|  | Power supply socket, straight | 7/8" connection, 5-pin | 543107 NECU-G78G5-C2 |
| | | 7/8" connection, 4-pin | 543108 NECU-G78G4-C2 |
|  | 7/8" power supply socket, 5-pin, angled socket/open cable end, 5-wire | 2 m | 573855 NEBU-G78W5-K-2-N-LE5 |
|  | Power supply socket M12x1, L-coded, straight | 5-pin | 8166793 NECL-L12G5-C2-Q10 |
| | Power supply plug M12x1, L-coded, straight | 5-pin | 8166791 NECL-S-L12G5-C2-Q10 |
|  | Power supply socket M12x1, L-coded, angled | 5-pin | 8166794 NECL-L12W5-C2-Q10 |
| | Power supply plug M12x1, L-coded, angled | 5-pin | 8166792 NECL-S-L12W5-C2-Q10 |
|  | Push-pull power supply socket, plug pattern PP, fulfils requirements to AIDA | 5-pin | 5195383 NECU-M-PPG5PP-C1-PN |
|  | Straight plug, spring-loaded terminal, for left-hand end plate with system supply | 7-pin | 576319 NECU-L3G7-C1 |
| Hood | | | |
|  | Mounting rail for attaching the hood | 1000 mm | 572256 CAFC-X1-S |
|  | Mounting kit for CPX hood | | 572257 CAFC-X1-BE |
|  | Hood section for CPX terminal including mounting attachments for connecting several hood sections in series | 200 mm | 572258 CAFC-X1-GAL-200 |
| | | 300 mm | 572259 CAFC-X1-GAL-300 |
| Screws | | | |
|  | Screws for mounting the bus node/connection block on the plastic interlinking block | Bus node/metal connection block | 550218 CPX-DPT-30X32-S-4X |
| | Screws for mounting the bus node/connection block on the metal interlinking block | Bus node/plastic connection block | 550219 CPX-M-M3x22-4x |
| | | Bus node/metal connection block | 550216 CPX-M-M3x22-S-4x |
|  | Screws for mounting an inscription label on the bus node CPX-M-FB45 | 12 pieces | 550222 CPX-M-M2.5X8-12X |

Accessories

| Ordering data – Accessories | | Part no. | Type |
|---|--|--------------------------------|---------------------------------|
| Designation | | | |
| Mounting | | | |
|  | Attachment for wall mounting (for long valve terminals, 10 pieces) | Version for manifold sub-bases | 529040 CPX-BG-RW-10x |
|  | Attachment for wall mounting, version for metal manifold sub-bases | 2 mounting brackets, 4 screws | 550217 CPX-M-BG-RW-2X |
| | | 1 mounting bracket, 2 screws | 2721419 CPX-M-BG-VT-2X |
| Covers and attachments | | | |
|  | Cover for CPX-AB-8-KL-4POL (IP65, IP67) | | 538219 AK-8KL |
| | <ul style="list-style-type: none"> • 8 cable through feeds M9 • 1 cable through feed for multi-pin plug Fittings kit | | 538220 VG-K-M9 |
|  | Screening plate for M12 connections | | 526184 CPX-AB-S-4-M12 |
|  | Earthing element (5 pieces), for right-hand/left-hand end plate (plastic interlinking blocks) | | 538892 CPX-EPFE-EV |
|  | Inspection cover, transparent | | 533334 AK-SUB-9/15-B |
|  | Transparent cover for DIL switch | | 548757 CPX-AK-P |
| | Cover for DIL switch | | 548754 CPX-M-AK-M |
|  | Cover for RJ45 connection | | 534496 AK-RJ45 |
|  | Cover cap for RJ45 push-pull connection | | 548753 CPX-M-AK-C |
|  | Cover cap for bus connection | | 2873540 CPX-M-AK-D |
|  | Cover cap for closing off unused connections (10 pieces) | For M8 connections | 177672 ISK-M8 |
| | | For M12 connections | 165592 ISK-M12 |
|  | Coding element, so that a coded socket NECU-L3G8 can only be inserted in the matching coded connection block CPX-P-AB-2XKL (96 of each) | For NECU-L3G8 | 565713 CPX-P-KDS-AB-2XKL |

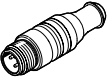
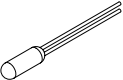
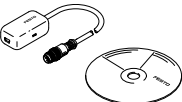
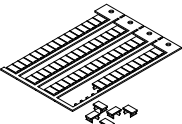
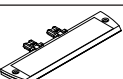
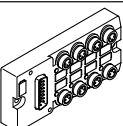
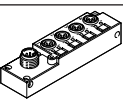
Accessories

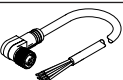
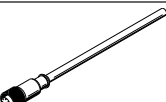
| Ordering data – Accessories | | Part no. | Type | |
|--|--|----------------------|---------------------|-----------------------|
| Designation | | | | |
| Function blocks | | | | |
|  | Terminating resistor, M12, B-coded for PROFIBUS | 1072128 | CACR-S-B12G5-220-PB | |
|  | PT1000 temperature sensor for cold junction compensation | 553596 | CPX-W-PT1000 | |
|  | 5-pin M12 to mini USB socket adapter and controller software | 547432 | NEFC-M12G5-0.3-U1G5 | |
| Inscription labels | | | | |
|  | Inscription labels 6x10 mm, 64 pieces, in frame | 18576 | IBS-6x10 | |
|  | Inscription label holder for connection block | 536593 | CPX-ST-1 | |
| Multi-pin plug distributor | | | | |
|  | Sub-D plug, 15-pin | 8x socket M8, 3-pin | 177669 | MPV-E/A08-M8 |
| | | 12x socket M8, 3-pin | 177670 | MPV-E/A12-M8 |
|  | Plug M12, 8 pin | 4x socket M8, 3-pin | 574586 | NEDU-L4R1-M8G3L-M12G8 |
| | | 6x socket, M8, 3-pin | 574587 | NEDU-L6R1-M8G3L-M12G8 |
| Connecting cable for multi-pin plug distributor | | | | |
|  | Sub-D socket, 15-pin Open cable end, 15-wire | 5 m | 177673 | KMPV-SUB-D-15-5 |
| | | 10 m | 177674 | KMPV-SUB-D-15-10 |
|  | Angled socket, M12, 8-pin, Open cable end, 8-wire | Length: 2 m | 542256 | NEBU-M12W8-K-2-N-LE8 |
| | | Length: 5 m | 542257 | NEBU-M12W8-K-5-N-LE8 |
| | | Length: 10 m | 570007 | NEBU-M12W8-K-10-N-LE8 |
|  | Straight socket, M12, 8-pin, Open cable end, 8-wire | Length: 2 m | 525616 | SIM-M12-8GD-2-PU |
| | | Length: 5 m | 525618 | SIM-M12-8GD-5-PU |
| | | Length: 10 m | 570008 | SIM-M12-8GD-10-PU |