

Servo drive CMMT-AS

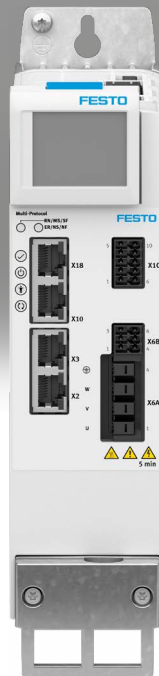

Festo Core Range
Solves the majority of your automation tasks

Worldwide: Quickest delivery – wherever, whenever
Simply good: Expected high Festo quality
Fast: Easy and fast to select

With the Festo Core Range, we have selected the most important products and functions from our broad product catalogue, and added the quickest delivery.

The Core Range offers you the best value for your automation tasks.

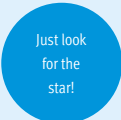

Key features

At a glance

- Universal servo drive for PM-synchronous servo motors with up to 12000 W continuous power
- Supports the motor series EMMT-AS, EMME-AS and EMMB-AS as well as third-party motors
- Integrated single-phase/three-phase mains connection 230/400 V AC, mains filter and braking resistor, connection option for external braking resistor
- Precise torque, speed and position control
- Motion from point-to-point to interpolated motion
- Comprehensively integrated protective functions for the servo drive, motor and axis with automatic motor shut-down/quick stop
- Bus protocols
- Configuration:
 - Automatically with the "Festo Automation Suite" as well as auto-tuning
 - Directly via fieldbus and PLC
 - Data backup concept via PLC or operating panel CDSB
- Supports digital absolute encoders (EnDat, Hiperface, Nikon-A) in the motor as well as incremental (A/B, Sin/Cos) displacement encoders on the axis
- Integrated safety functions:
 - Safe torque off (STO) up to SIL3/Cat. 4 PL e
 - Safe stop 1 (SS1) when using a suitable external safety relay unit and suitable circuitry for the servo drive
 - Safe brake control (SBC) up to SIL3/Cat. 3 PL e
 - Diagnostic outputs STA and SBA for feedback of the active safety function

EtherCAT

PROFI
NET

EtherNet/IP

Modbus

- Modbus TCP is available as an additional protocol for all EtherNet/IP devices
- Prepared device description files and function blocks for integration in PLC systems

The technology in detail

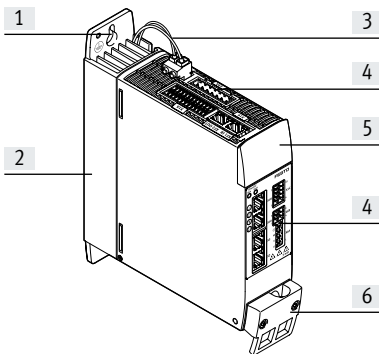

- [1] Elongated hole for mounting the servo drive on the control cabinet back wall
- [2] Cooling element for dissipating heat. The internal braking resistor is housed in the cooling element
- [3] Connection for braking resistor
- [4] Connections
- [5] Blind plate (optionally with plug-on operating panel CDSB → page 16)
- [6] Shield clamp and strain relief

Electric Motion Sizing

Configuring electromechanical drives



Create the optimum drive package quickly and reliably. Electric Motion Sizing calculates suitable combinations of electric axis, electric motor and servo drive using just a few application details. It provides you with all the relevant data including the bill of materials and documentation for the selected combination. This avoids design errors and results in significantly improved energy efficiency for the system.

A smooth connection to the Festo Automation Suite also makes commissioning easier for you.

To find out more, go to www.festo.com/ems

Key features

Library for EPLAN

→ www.festo.de/eplan

EPLAN macros for fast and reliable planning of electrical projects in combination with servo drives, motors and cables. This enables a high level of planning reliability, standardised documentation, and there is no need to create symbols, graphics and master data.

Festo Automation Suite

Parameterisation and programming software for electronic devices from Festo

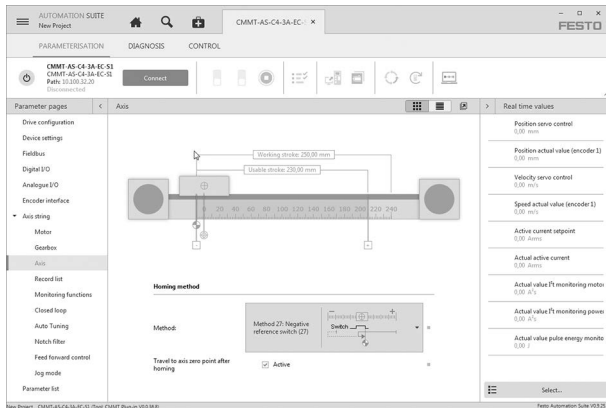

- Parameterisation, programming and commissioning in a clear and user-friendly interface
- Optimum support for complex processes thanks to guided wizards (e.g. for commissioning, drive configuration, etc.)
- Fast access to the required documents and additional information
- Easy integration of electric drives in the controller programming

System overview

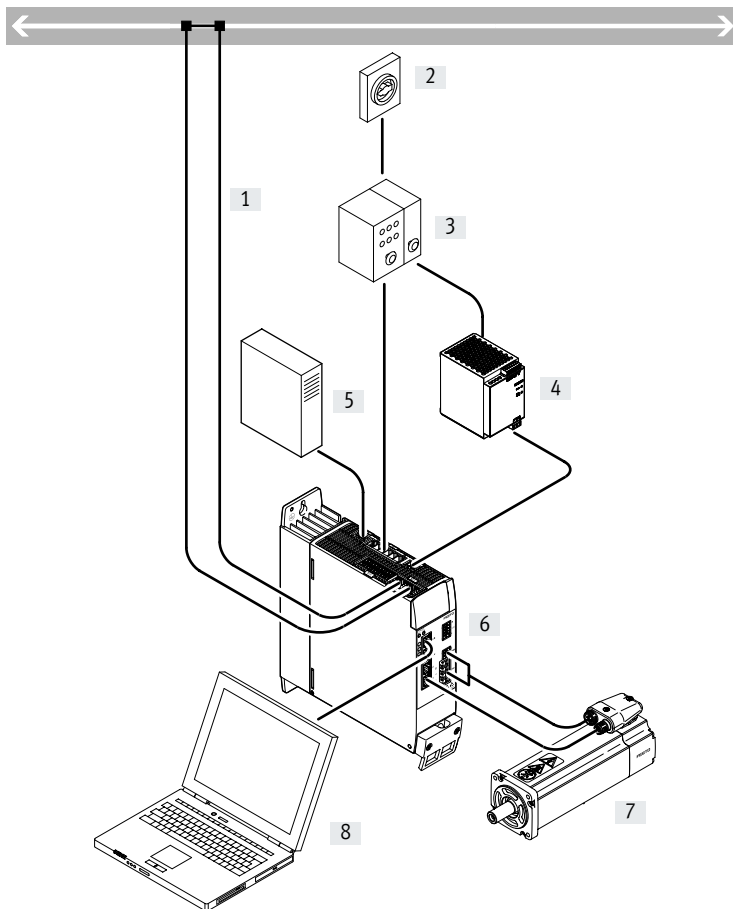

- [1] Bus/network
- [2] Main switch
- [3] Circuit breaker/fuses
- [4] Power supply unit for logic voltage supply 24 V DC (PELV)
- [5] External braking resistor (optional)
- [6] Servo drive CMMT-AS
- [7] Servo motor
- [8] PC with Ethernet connection for parameterisation

Type codes

| 001 | Series |
|-------------|------------------|
| CMMT | Motor controller |

| 002 | Motor type |
|-----------|----------------|
| AS | AC synchronous |

| 003 | Nominal current |
|------------|-----------------|
| C2 | 2 A |
| C3 | 3 A |
| C4 | 4 A |
| C5 | 5 A |
| C7 | 7 A |
| C12 | 12 A |
| C18 | 18 A |
| C25 | 25 A |

| 004 | Nominal input voltage |
|------------|-----------------------|
| 3A | 230 V AC/50-60Hz |
| 11A | 400 V AC/50-60Hz |

| 005 | Number of phases |
|-----------|------------------|
| | Single-phase |
| P3 | Three-phase |

| 006 | Bus protocol/activation |
|-----------|-------------------------|
| MP | Multiprotocol |

| 007 | Safety function |
|-----------|-----------------|
| S1 | Standard safety |

Datasheet

Bus protocols



EtherNet/IP



General technical data

| CMMT-AS- | C2-3A | C4-3A | C2-11A | C3-11A | C5-11A | C7-11A | C12-11A | C18-11A | C25-11A |
|---------------------------|------------------------------------------------------------------------------------------------------------------------------------------------------------------------------------------------------------------------------------------------------------------------------------------------------------------------------------------------------------------------------------------------------------------------------------------------------------------------------------------------------------------------------------------------------------------------|-------|--------|--------|--------|--------|---------|---------|---------|
| Type of mounting | Mounting plate, screwed in | | | | | | | | |
| Display | Green/yellow/red LED or operating panel CDSB with plain-text message | | | | | | | | |
| Controller operating mode | <ul style="list-style-type: none"> • Cascade controller • P position controller • PI speed controller • PI current controller for F or M • Profile operation with record and direct mode • Interpolated mode via fieldbus • Homing/setup mode/auto-tuning | | | | | | | | |
| Operating mode | <ul style="list-style-type: none"> • Field-oriented control, position resolution 24-bit/rev. • Sampling rate 16 kHz • PWM with 8 or 16 kHz, vector modulation with third harmonic (16 kHz only with CMMT-AS-C2-3A and CMMT-AS-C4-3A) • Real-time data acquisition: <ul style="list-style-type: none"> – 2x input position capture – 2x output position trigger – 2x position encoder input – 1x SYNC interface for encoder emulation or encoder input | | | | | | | | |
| Mounting position | Vertical | | | | | | | | |
| Product weight [g] | 1300 | 1400 | 2100 | 2100 | 2200 | 4100 | 4100 | 4300 | 4300 |

Bus protocols

| Interface | EtherCAT® | PROFINET RT/IRT | EtherNet/IP | Modbus TCP |
|----------------------------------------|----------------------------------|---------------------------------------|----------------------------------|----------------------------------|
| Function | Bus connection incoming/outgoing | | | |
| Process interfacing | Interpolated mode CSP | AC1: adjustable-speed drives | Adjustable-speed drives | Adjustable-speed drives |
| | Interpolated mode CSV | AC3: drives with positioning function | Drives with positioning function | Drives with positioning function |
| | Interpolated mode CST | AC4: synchronous servo application | | |
| | Point-to-point mode PP | | | |
| | Point-to-point mode PV | | | |
| | Point-to-point mode PT | | | |
| | Homing mode HM | | | |
| | Record table with 128 entries | | | |
| Communication profile | CiA402 | PROFIdrive | DriveProfile | DriveProfile |
| | CoE (CANopen over EtherCAT) | | | |
| | EoE (Ethernet over EtherCAT) | | | |
| Max. fieldbus transmission rate [Mbps] | 100 | | | |
| Connection type | 2x bushing | | | |
| Connection technology | RJ45 | | | |

Datasheet

| Electrical data | | C2-3A | C4-3A | C2-11A | C3-11A | C5-11A |
|------------------------------------------------|---------------------|-------------------------|-------|-------------------------|--------|-----------------------|
| Output connection data | | | | | | |
| Output voltage range | [V AC] | 3x (0 – Input) | | | | |
| Nominal current per phase | [A _{eff}] | 2 | 4 | 1.7 | 2.5 | 5 |
| Peak current per phase | [A _{eff}] | 6 | 12 | 5.1 | 7.5 | 15 |
| Max. peak current duration (at fs ≥ 5 Hz) | [s] | 2 | | | | |
| Nominal power | [W] | 350 | 700 | 800 | 1200 | 2500 |
| Peak power | [W] | 1000 | 2000 | 2400 | 3600 | 7500 |
| Output frequency | [Hz] | 0 ... 599 | | | | |
| Max. motor cable length ¹⁾ | [m] | 25/50 | | 50/100 | | |
| Load voltage AC | | | | | | |
| Nominal operating voltage phases | | 1-phase | | 3-phase | | |
| Voltage input range | [V AC] | 100 ... 230 (–20%/+15%) | | 200 ... 480 (–10%/+10%) | | |
| Nominal operating voltage | [V AC] | 230 | | 400 | | |
| Nominal current | [A _{eff}] | 2.8 | 5.6 | 2 | 3 | 6 |
| Peak current | | 8.4 | 16.8 | 6 | 9 | 18 |
| Mains frequency | [Hz] | 48 ... 62 | | | | |
| System voltage in accordance with EN 61800-5-1 | [V] | 300 | | | | |
| Max. short circuit current rating of the mains | [kA] | 100 | | 10 | | |
| Mains types of system earthing | | TN, TT, IT | | TN, IT | | |
| Mains filters | | Built in | | | | |
| Load voltage DC | | | | | | |
| Voltage input range | [V DC] | 80 ... 360 | | 80 ... 700 | | |
| Max. intermediate circuit voltage | [V DC] | 395 | | 800 | | |
| Nominal current | | | | | | |
| at 320 V DC | [A] | 1.3 | 2.6 | – | – | – |
| at 560 V DC | [A] | – | – | 1.5 | 2.3 | 4.7 |
| Logic supply | | | | | | |
| Nominal voltage | [V DC] | 24 ±20% | | | | |
| Max. current consumption | [A] | 0.5/2.3 ²⁾ | | | | 0.5/2.5 ²⁾ |

- 1) Without/with external mains filter
- 2) Max. current at full expansion, with two position encoders, brake output and all I/Os with max. specified loads connected

| Braking resistor | | C2-3A | C4-3A | C2-11A | C3-11A | C5-11A |
|-----------------------|------|-------------|------------|-------------|-------------|------------|
| Integrated | | | | | | |
| Resistance | [Ω] | 100 | | 130 | | |
| Pulse power | [kW] | 1.6 | | 5 | | |
| Pulse energy | [Ws] | 230 | | 850 | | |
| Nominal power | [W] | 23 | | 48 | 48 | 58 |
| External | | | | | | |
| Resistance | [Ω] | 100 ... 160 | 67 ... 100 | 130 ... 250 | 130 ... 250 | 80 ... 130 |
| Max. continuous power | [W] | 180 | 350 | 400 | 600 | 1200 |

Datasheet

| Electrical data | | C7-11A | C12-11A | C18-11A | C25-11A |
|------------------------------------------------|---------------------|-------------------------|---------|-----------------------|---------|
| CMMT-AS- | | | | | |
| Output connection data | | | | | |
| Output voltage range | [V AC] | 3x (0 – Input) | | | |
| Nominal current per phase | [A _{eff}] | 7 | 12 | 18 | 25 |
| Peak current per phase | [A _{eff}] | 21 | 36 | 54 | 75 |
| Max. peak current duration (at fs ≥ 5 Hz) | [s] | 2 | | | |
| Nominal power | [W] | 4000 | 6000 | 9000 | 12000 |
| Peak power | [W] | 12000 | 18000 | 27000 | 36000 |
| Output frequency | [Hz] | 0 ... 599 | | | |
| Max. motor cable length ¹⁾ | [m] | 25/100 | | 50/100 | |
| Load voltage AC | | | | | |
| Nominal operating voltage phases | | 3-phase | | | |
| Voltage input range | [V AC] | 200 ... 480 (-10%/+10%) | | | |
| Nominal operating voltage | [V AC] | 400 | | | |
| Nominal current | [A _{eff}] | 9 | 15 | 22 | 29 |
| Peak current | | 27 | 45 | 66 | 87 |
| Mains frequency | [Hz] | 48 ... 62 | | | |
| System voltage in accordance with EN 61800-5-1 | [V] | 300 | | | |
| Max. short circuit current rating of the mains | [kA] | 10 | | | |
| Mains types of system earthing | | TN, IT | | | |
| Mains filters | | Built in | | | |
| Load voltage DC | | | | | |
| Voltage input range | [V DC] | 80 ... 700 | | | |
| Max. intermediate circuit voltage | [V DC] | 800 | | | |
| Nominal current | | | | | |
| at 560 V DC | [A] | 7.5 | 11.2 | 17 | 23.5 |
| Logic supply | | | | | |
| Nominal voltage | [V DC] | 24 ±20% | | | |
| Max. current consumption | [A] | 0.5/2.5 ²⁾ | | 0.5/3.5 ²⁾ | |

1) Without/with external mains filter

2) Max. current at full expansion, with two position encoders, brake output and all I/Os with max. specified loads connected

| Braking resistor | | C7-11A | C12-11A | C18-11A | C25-11A |
|-----------------------|------|-----------|-----------|-----------|-----------|
| CMMT-AS- | | | | | |
| Integrated | | | | | |
| Resistance | [Ω] | 47 | | 24 | |
| Pulse power | [kW] | 13.6 | | 24 | |
| Pulse energy | [Ws] | 1200 | | | |
| Nominal power | [W] | 100 | | | |
| External | | | | | |
| Resistance | [Ω] | 60 ... 85 | 40 ... 60 | 30 ... 40 | 20 ... 30 |
| Max. continuous power | [W] | 1500 | 3000 | 4500 | 5000 |

Datasheet

| Motor auxiliary connections | | C2-3A | C4-3A | C2-11A | C3-11A | C5-11A |
|------------------------------|------------------------------------------------------------------------|-------|-------|--------|--------|--------|
| CMMT-AS- | | | | | | |
| Motor temperature monitoring | | | | | | |
| Digital | Connection for temperature switch (PTC, N/C contact or N/O contact) | | | | | |
| Analogue | Connection for analogue temperature sensor (KTY81 ... 84, NTC, Pt1000) | | | | | |
| Output for holding brake | | | | | | |
| Version | High-side switch; 24 V; monitored internally | | | | | |
| Output current | [A] | 1.0 | | | | 1.3 |
| Output for 2nd brake | | | | | | |
| Version | High-side switch; 24 V; monitored internally | | | | | |
| Output current | [A] | 0.1 | | | | |

| Motor auxiliary connections | | C7-11A | C12-11A | C18-11A | C25-11A | |
|------------------------------|------------------------------------------------------------------------|--------|---------|---------|---------|--|
| CMMT-AS- | | | | | | |
| Motor temperature monitoring | | | | | | |
| Digital | Connection for temperature switch (PTC, N/C contact or N/O contact) | | | | | |
| Analogue | Connection for analogue temperature sensor (KTY81 ... 84, NTC, Pt1000) | | | | | |
| Output for holding brake | | | | | | |
| Version | High-side switch; 24 V; monitored internally | | | | | |
| Output current | [A] | 1.5 | | | 2.3 | |
| Output for 2nd brake | | | | | | |
| Version | High-side switch; 24 V; monitored internally | | | | | |
| Output current | [A] | 0.1 | | | | |

Datasheet

| Interfaces | | |
|---------------------------------|---------------------------------------------------------------|----------|
| Ethernet | | |
| Function | Parameterisation and commissioning | |
| Protocol | DHCP | |
| | TCP/IP | |
| Position encoders | | |
| Function of position encoder 1 | ENDAT 2.1 encoder | |
| | ENDAT 2.2 encoder | |
| | HIPERFACE encoder | |
| | Incremental encoder | |
| | SIN/COS encoder | |
| | BISS-C | |
| | Nikon-A | |
| Function of position encoder 2 | Incremental encoder | |
| | ENDAT 2.2 encoder | |
| | HIPERFACE encoder | |
| | SIN/COS encoder | |
| Synchronisation | | |
| Function | Encoder emulation A/B/Z | |
| | Encoder input A/B/Z | |
| Encoder output, characteristics | 1 MHz maximum output frequency | |
| | Resolution up to 16384 ppr | |
| Encoder input, characteristics | 1 MHz maximum input frequency | |
| | Resolution up to 16384 ppr | |
| Input/output | | |
| Digital inputs | | |
| Number | 10 ... 12 (depending on device design) | |
| Number of high-speed | 2 | |
| Time resolution of high-speed | [μ s] | 1 |
| Switching logic | PNP | |
| Characteristics | Not galvanically isolated | |
| | Freely configurable in some cases | |
| | Safety inputs in some cases | |
| Specification | Based on IEC 61131-2, type 3 | |
| Operating range | [V] | 0 ... 30 |
| Digital outputs | | |
| Number | 4 ... 6 (depending on device design) | |
| Number of high-speed | 2 | |
| Time resolution of high-speed | [μ s] | 1 |
| Switching logic | PNP | |
| Characteristics | Not galvanically isolated | |
| | Freely configurable in some cases | |
| Max. current | [mA] | 20 |
| Analogue setpoint inputs | | |
| Number | 1 | |
| Characteristics | Differential input | |
| | Configurable for current/force, rotational speed and position | |
| Operating range | [V] | ± 10 |
| Impedance | [k Ω] | 70 |
| Floating switching outputs | | |
| Number | 1 | |
| Max. current | [mA] | 50 |

Datasheet

| Safety characteristics | | |
|-------------------------------------------------------|------|-----------------------------------------------------------------------------------------------------------------------|
| Safety function to EN 61800-5-2 | | Safe torque off (STO) Safe stop 1 (SS1) Safe brake control (SBC) |
| Performance Level (PL) to EN ISO 13849-1 | | |
| Safe torque off (STO) | | Category 4, Performance Level e |
| Safe brake control (SBC) | | Category 3, Performance Level e |
| Safety integrity level (SIL) to EN 62061 and EN 61508 | | |
| Safe torque off (STO) | | SIL 3/SILCL 3 |
| Safe brake control (SBC) | | SIL 3/SILCL 3 |
| Certificate issuing authority and no. | | German Technical Control Board (TÜV) Rheinland 01/205/5640.01/23 |
| Proof test interval | | |
| Safe torque off (STO) | | Up to 20a |
| Safe brake control (SBC) | | 24 h |
| Diagnostic coverage | [%] | Up to 97 |
| Safe failure fraction (SFF) | [%] | Up to 99 |
| Hardware fault tolerance | | 1 |
| Operating and environmental conditions | | |
| Degree of protection | | IP20 |
| Ambient temperature ¹⁾ | [°C] | 0 ... +50 |
| Storage temperature | [°C] | -25 ... +55 |
| Relative humidity | [%] | 5 ... 90 (non-condensing) |
| Protection class | | I |
| Overvoltage category | | III |
| Pollution degree | | 2 |
| Surge resistance | [kV] | 6 |
| Max. setup altitude ²⁾ | [m] | 2000 |
| Shock and vibration resistance | | To EN 61800-2 and EN 61800-5-1 |
| CE marking (see declaration of conformity) | | To EU EMC Directive ³⁾ To EU Machinery Directive To EU Low Voltage Directive To EU RoHS Directive |
| UKCA marking (see declaration of conformity) | | To UK EMC regulations To UK RoHS regulations To UK regulations for machines |
| KC marking | | KC EMC |
| Certification | | c UL us - Listed (OL) RCM |
| LABS (PWIS) conformity | | VDMA24364 zone III |
| Note on materials | | RoHS-compliant |

1) Above 40 °C, the power is reduced by 3% per K.

2) Above 1000 m, the power is reduced by 1% per 100 m.

3) For information about the area of use, see the EC declaration of conformity at: www.festo.com/sp → Certificates.

If the devices are subject to usage restrictions in residential, commercial or light-industrial environments, further measures for the reduction of the emitted interference may be necessary.

Datasheet

View of servo drives

Front view

- [1] PE connection, housing
- [2] [X5] Connection for operating panel (behind blind plate)
- [3] [X18] Standard Ethernet
- [4] [X10] Device synchronisation
- [5] [X3] Position sensor 2
- [6] [X2] Position sensor 1

- [7] [X9B] Connection for braking resistor
- [8] [X1C] Inputs/outputs for the axis
- [9] [X6B] Motor auxiliary connection
- [10] [X6A] Motor phase connection
- [11] Shield clamp and strain relief
- [12] DIL switch for the manual changeover of the fieldbuses

CMMT-AS-...-3A

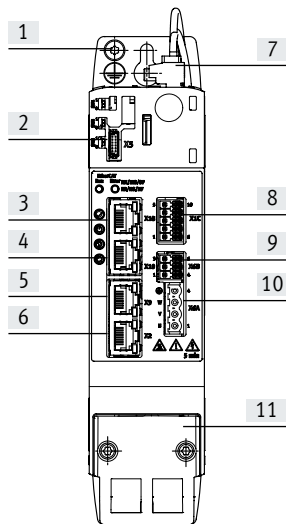

CMMT-AS-C2/C3/C5-...-11A

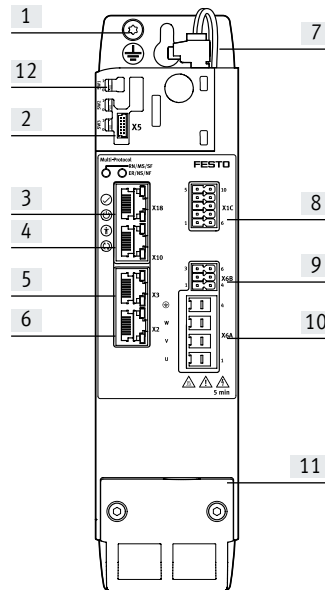

CMMT-AS-C7/C12/C18/C25-...-11A

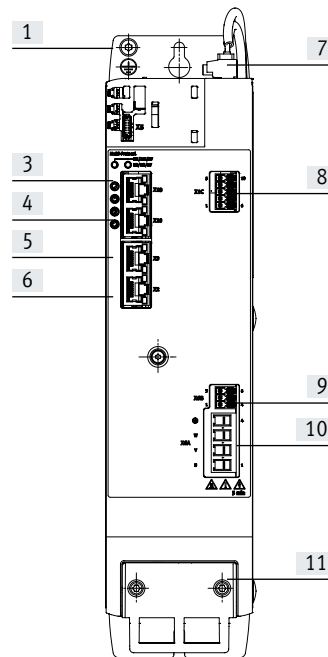

Top view

- [1] Cooling element
- [2] [X1A] I/O interface
- [3] [XF2 OUT] RTE interface port 2
- [4] [XF1 IN] RTE interface port 1

- [5] [X9B] Connection for braking resistor
- [6] [X9A] Supply: mains, DC link and logic voltage
- [7] [X9A] Supply: mains and DC link voltage
- [8] [X9C] Supply: logic voltage

CMMT-AS-...-3A

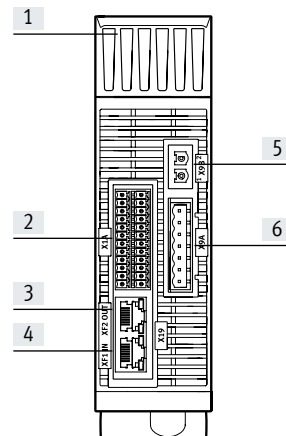

CMMT-AS-C2/C3/C5-...-11A

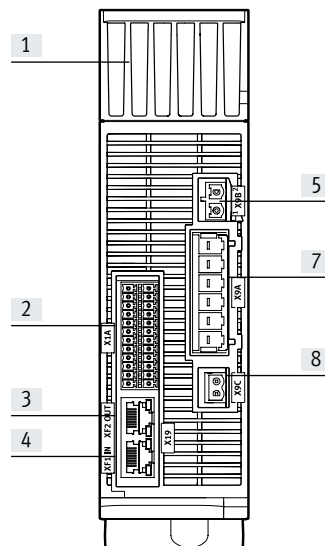

CMMT-AS-C7/C12/C18/C25-...-11A

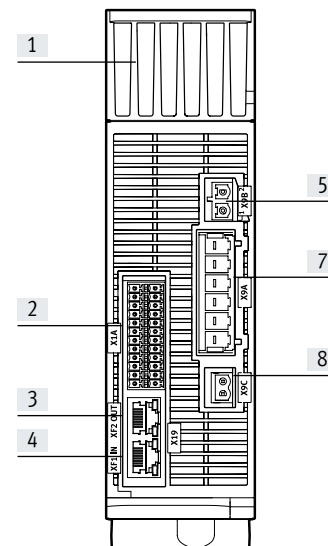

Datasheet

Installation clearance for servo drives

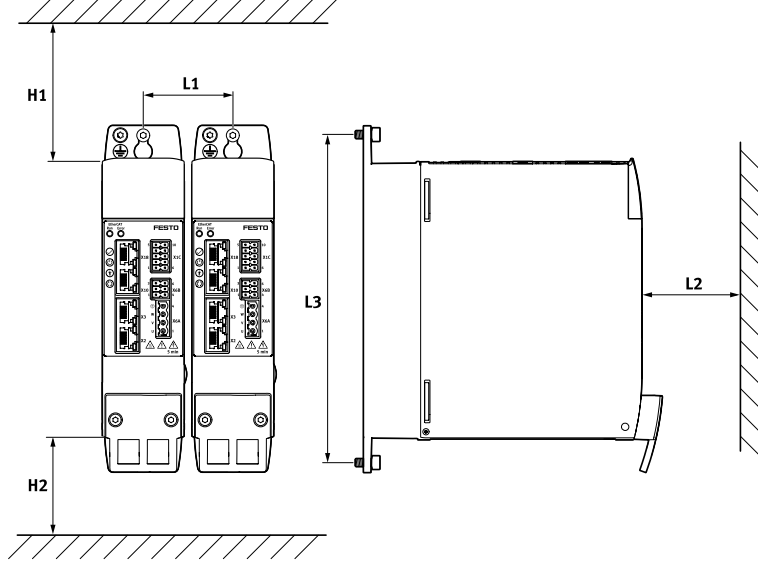

| Type | H1 | H2 ¹⁾ | L1 | L2 | L3 |
|-----------------|-----|------------------|----|----|-----|
| CMMT-AS-C2-3A | 70 | 70 | 52 | 70 | 200 |
| CMMT-AS-C4-3A | | | | | |
| CMMT-AS-C2-11A | 100 | 70 | 62 | 70 | 230 |
| CMMT-AS-C3-11A | | | | | |
| CMMT-AS-C5-11A | | | | | |
| CMMT-AS-C7-11A | 100 | 70 | 78 | 70 | 300 |
| CMMT-AS-C12-11A | | | | | |
| CMMT-AS-C18-11A | | | | | |
| CMMT-AS-C25-11A | | | | | |

1) An installation clearance of 150 mm underneath the servo drive is recommended for optimum wiring of the motor or encoder cable

Datasheet

Dimensions

Download CAD data → www.festo.com

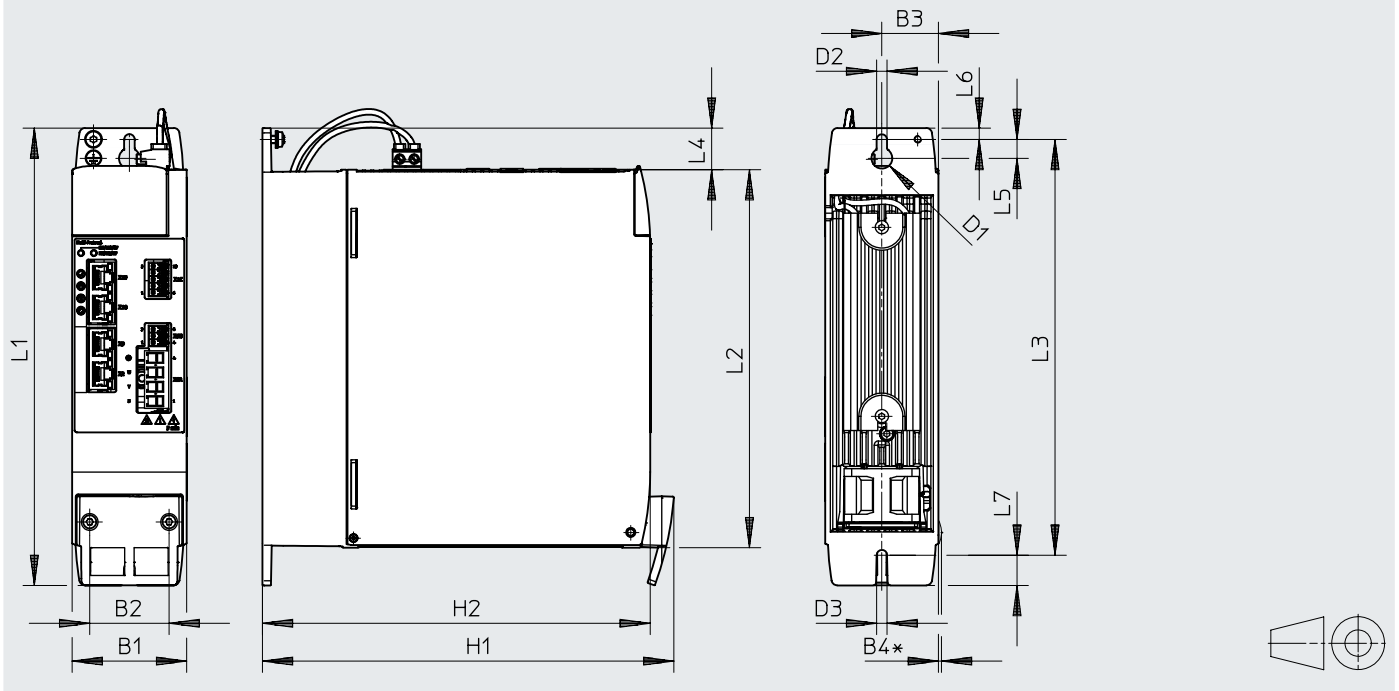

| Type | B1 | B2 | B3 | B4 | D1 ∅ | D2 | D3 | H1 |
|-----------------|----|----|------|-----|---------|-----|-----|-----|
| CMMT-AS-C2-3A | 50 | 34 | 25 | - | 11 | 5.5 | 5.5 | 183 |
| CMMT-AS-C4-3A | | | | | | | | |
| CMMT-AS-C2-11A | 60 | 42 | 29.7 | 1.6 | 11 | 5.5 | 5.5 | 218 |
| CMMT-AS-C3-11A | | | | | | | | |
| CMMT-AS-C5-11A | | | | | | | | |
| CMMT-AS-C7-11A | 75 | 44 | 37.5 | 1.6 | 11 | 5.5 | 5.5 | 224 |
| CMMT-AS-C12-11A | | | | | | | | |
| CMMT-AS-C18-11A | | | | | | | | |
| CMMT-AS-C25-11A | | | | | | | | |

| Type | H2 | L1 | L2 | L3 | L4 | L5 | L6 | L7 |
|-----------------|-----|-----|-----|-----|----|----|----|----|
| CMMT-AS-C2-3A | 170 | 212 | 170 | 200 | 22 | 10 | 6 | 9 |
| CMMT-AS-C4-3A | | | | | | | | |
| CMMT-AS-C2-11A | 205 | 242 | 198 | 220 | 22 | 10 | 6 | 16 |
| CMMT-AS-C3-11A | | | | | | | | |
| CMMT-AS-C5-11A | | | | | | | | |
| CMMT-AS-C7-11A | 205 | 319 | 276 | 300 | 22 | 10 | 6 | 13 |
| CMMT-AS-C12-11A | | | | | | | | |
| CMMT-AS-C18-11A | | | | | | | | |
| CMMT-AS-C25-11A | | | | | | | | |

Datasheet

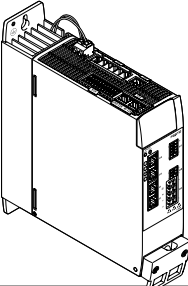
| Ordering data | Description | Number of phases | Nominal current | Part no. | Type |
|----------------------------------------------------------------------------------|---------------------------------------------------------------------------------------------------|------------------|-----------------|--------------------------|-------------------------|
|  | The assortment of plugs NEKM (→ page 16) is included in the scope of delivery of the servo drive. | 1-phase | 2 | ★ 8143163 | CMMT-AS-C2-3A-MP-S1 |
| | | 4 | ★ 8143164 | CMMT-AS-C4-3A-MP-S1 | |
| | | 3-phase | 2 | ★ 8143165 | CMMT-AS-C2-11A-P3-MP-S1 |
| | | 3 | ★ 8143166 | CMMT-AS-C3-11A-P3-MP-S1 | |
| | | 5 | ★ 8143167 | CMMT-AS-C5-11A-P3-MP-S1 | |
| | | 7 | ★ 8143168 | CMMT-AS-C7-11A-P3-MP-S1 | |
| | | 12 | ★ 8143169 | CMMT-AS-C12-11A-P3-MP-S1 | |
| | | 18 | ★ 8157801 | CMMT-AS-C18-11A-P3-MP-S1 | |
| | | 25 | ★ 8157802 | CMMT-AS-C25-11A-P3-MP-S1 | |

Ordering data – Modular product system

| Ordering table | | | | | |
|-------------------------|-----------------|----------------|-----------------|-------------|---------------|
| Series | | | Condi- tions | Code | Enter code |
| CMMT-AS-... | -3A | -11A | | | |
| Module no. | 5111184 | 5111189 | | | |
| Series | CMMT | | | CMMT | CMMT |
| Motor type | AC synchronous | | | -AS | -AS |
| Nominal current | | | | | |
| 2 A | | | | -C2 | |
| 3 A | – | | [1] | -C3 | |
| 4 A | | – | [2] | -C4 | |
| 5 A | – | | [1] | -C5 | |
| 7 A | – | | [1] | -C7 | |
| 12 A | – | | [1] | -C12 | |
| 18 A | – | | [1] | -C18 | |
| 25 A | – | | [1] | -C25 | |
| Nominal input voltage | | | | | |
| 230 VAC/50-60 Hz | | – | | -3A | |
| 400 VAC | – | | | -11A | |
| Number of phases | | | | | |
| Single-phase | | – | | | |
| Three-phase | – | | | -P3 | |
| Bus protocol/activation | Multiprotocol | | | -MP | |
| Safety function | Standard safety | | | -S1 | -S1 |

[1] C3, C5, C7, C12, C18, C25 Only with nominal input voltage 11A

[2] C4) Only with nominal input voltage 3A

Accessories

Ordering data – Included in the scope of delivery of the servo drive

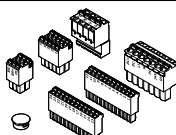
| | Description | For CMMT-AS... | | Part no. | Type |
|----------------------------------------------------------------------------------|-----------------------------------------------------------------------------------------------|----------------|------|-----------|------------------|
| | | -3A | -11A | | |
| Assortment of plugs | | | | | |
|  | For single wiring connection | ■ | - | ★ 4325822 | NEKM-C6-C16-S |
| | For double wiring connection | ■ | - | ★ 5054513 | NEKM-C6-C16-D |
| | For single wiring connection | - | ■ | ★ 5119205 | NEKM-C6-C45-P3-S |
| | For double wiring connection | - | ■ | ★ 5118001 | NEKM-C6-C45-P3-D |
| | The assortment of plugs for double wiring connection is always supplied with the servo drive. | | | | |

Ordering data – Optional accessories

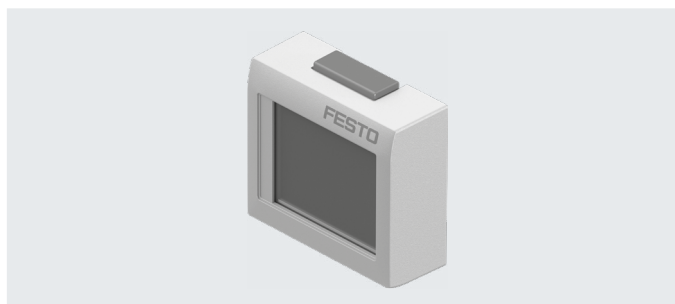

Operating panel CDSB-A1

- Text messages can be displayed in full. This allows errors, warnings and selected data to be read at a glance
 - Easy data backup of parameters and firmware in the unit for e.g. serial commissioning or device replacement
 - One operating panel can be used for several servo drives
 - Control element: Touchscreen
 - Display: colour TFT
 - Display size: 1.77"
 - User memory: 3 GB
 - USB interface: USB 2.0 type mini
- Additional technical data:
→ Internet: cdsb

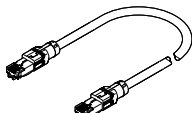

| Ambient temperature [°C] | Storage temperature [°C] | Degree of protection | Weight [g] | Part no. | Type |
|----------------------------------------------------------|--------------------------|----------------------|------------|-----------|---------|
| 0 ... 60 | -20 ... +70 | IP20 | 40 | ★ 8070984 | CDSB-A1 |
| Not included in the scope of delivery of the servo drive | | | | | |

Ordering data – Optional accessories

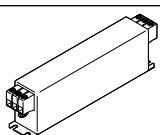
| | Description | Part no. | Type |
|------------------------------------------------------------------------------------|-----------------------------------------------------------------------------------------------------------------------------------------------------------------------------------------------------------------------------------------------------------------------------------------------------|-----------|------------------------------|
| Connecting cable | | | |
|  | <ul style="list-style-type: none"> • Patch cable for the daisy-chain connection of the bus interfaces X19A/B • Patch cable for master/slave functionality (X10-X11) • Ethernet category Cat 5e • Not included in the scope of delivery of the servo drive | ★ 8082383 | NEBC-R3G8-KS-0.2-N-S-R3G8-ET |
| Mains filters | | | |
|  | Single-phase, 8 A, sufficient for: 2x CMMT-AS-C2-3A or 1x CMMT-AS-C4-3A | ★ 8088928 | CAMF-C6-F-C8-3A |
| | Single-phase, 20 A, sufficient for: 6x CMMT-AS-C2-3A or 3x CMMT-AS-C4-3A | ★ 8088929 | CAMF-C6-F-C20-3A |
|  | Three-phase, 16 A, sufficient for: 8x CMMT-AS-C2-11A or 5x CMMT-AS-C3-11A or 2x CMMT-AS-C5-11A or 2x CMMT-AS-C7-11A or 1x CMMT-AS-C12-11A | 8096868 | CAMF-C6-F-C16-11A |
| | 3-phase, 42 A, sufficient for: 21x CMMT-AS-C2-11A or 14x CMMT-AS-C3-11A or 7x CMMT-AS-C5-11A or 5x CMMT-AS-C7-11A or 3x CMMT-AS-C12-11A or 1x CMMT-AS-C18-11A or 1x CMMT-AS-C25-11A | 8096894 | CAMF-C6-F-C42-11A |
| Not included in the scope of delivery of the servo drive | | | |

Accessories

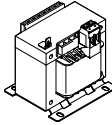
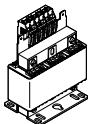
| Ordering data – Optional accessories | | | | | |
|-----------------------------------------------------------------------------------|-----------------------------------------------------------------------------------------------------|-----------|-------------------|--|--|
| Description | | Part no. | Type | | |
| Line choke | | | | | |
|  | Single-phase, 6 A, sufficient for: 2x CMMT-AS-C2-3A or 1x CMMT-AS-C4-3A | ★ 8088930 | CAMF-C6-FD-C6-3A | | |
|  | Three-phase, 6 A, sufficient for: 3x CMMT-AS-C2-11A or 2x CMMT-AS-C3-11A or 1x CMMT-AS-C5-11A | 8096867 | CAMF-C6-FD-C6-11A | | |
| Not included in the scope of delivery of the servo drive | | | | | |

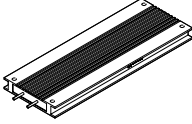
| Ordering data – Optional accessories | | | | | | Datasheets → Internet: cacr | |
|-----------------------------------------------------------------------------------|-------|-------------------------|----------------------------------|----------------------------------|----------|-----------------------------|--|
| | | Resistance value [Ω] | Nominal power at 380 V [W] | Pulse energy at 380 V [Ws] | Part no. | Type | |
| Braking resistor | | | | | | | |
|  | | | | | | | |
| For type CMMT-AS- | | | | | | | |
| C2-3A | C4-3A | | | | | | |
| – | ■ | 72 | 150 | 2000 | 1336611 | CACR-LE2-72-W500 | |
| ■ | ■ | 100 | 150 | 2000 | 1336615 | CACR-LE2-100-W500 | |
| – | ■ | 67 | 720 | 10800 | 1336617 | CACR-KL2-67-W1800 | |
| ■ | ■ | 100 | 720 | 10800 | 8091545 | CACR-KL2-100-W1800 | |
| Not included in the scope of delivery of the servo drive | | | | | | | |

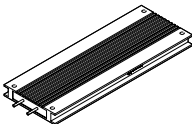

| Ordering data – Optional accessories | | | | | | Datasheets → Internet: cacr | | | |
|-------------------------------------------------------------------------------------|--------|-------------------------|----------------------------------|----------------------------------|----------|-----------------------------|-------|---------|--------------------|
| | | Resistance value [Ω] | Nominal power at 780 V [W] | Pulse energy at 780 V [Ws] | Part no. | Type | | | |
| Braking resistor | | | | | | | | | |
|  | | | | | | | | | |
| For type CMMT-AS- | | | | | | | | | |
| C2-11A | C3-11A | C5-11A | C7-11A | C12-11A | | | | | |
| – | – | – | – | ■ | 50 | 120 | 1800 | 2882342 | CACR-LE2-50-W500 |
| – | – | – | ■ | – | 72 | 120 | 1800 | 1336611 | CACR-LE2-72-W500 |
| – | – | ■ | – | – | 100 | 120 | 1800 | 1336615 | CACR-LE2-100-W500 |
| ■ | ■ | – | – | – | 240 | 120 | 1800 | 8091543 | CACR-LE2-240-W500 |
| – | – | – | – | ■ | 40 | 480 | 7200 | 2882343 | CACR-KL2-40-W2000 |
| – | – | – | ■ | – | 67 | 720 | 10800 | 1336617 | CACR-KL2-67-W1800 |
| ■ | ■ | – | – | – | 240 | 720 | 10800 | 8091544 | CACR-KL2-240-W1800 |
| – | – | ■ | – | – | 100 | 720 | 10800 | 8091545 | CACR-KL2-100-W1800 |
| Not included in the scope of delivery of the servo drive | | | | | | | | | |

Accessories

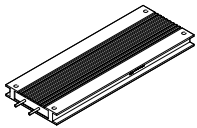
| Ordering data – Optional accessories | | | | | | Datasheets → Internet: cacr |
|--------------------------------------|------------------|------------------------|-----------------------|----------|------|-----------------------------|
| | Resistance value | Nominal power at 780 V | Pulse energy at 780 V | Part no. | Type | |
| | [Ω] | [W] | [Ws] | | | |

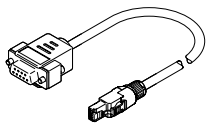
| Braking resistor | | | | | | |
|----------------------------------------------------------------------------------|---------|----|------|-------|----------------|--------------------------|
|  | | | | | | |
| For type CMMT-AS- | | | | | | |
| C18-11A | C25-11A | | | | | |
| ■ | – | 40 | 480 | 7200 | 2882343 | CACR-KL2-40-W2000 |
| – | ■ | 21 | 1440 | 21600 | 8140961 | CACR-KL2-21-W3600 |
| Not included in the scope of delivery of the servo drive | | | | | | |

| Ordering data – Optional accessories | | | |
|----------------------------------------------------------------------------------|------------------------------------------------------------------------------------------------------------------------------------------------------------------------------------------------------------------|----------------|-----------------------------|
| | Description | Part no. | Type |
| Adapter | | | |
|  | Required in combination with the linear drives EGC...-M1/M2, ELGA...-M1/M2 or ELCC...-M1 (external displacement encoder) as adapter between encoder cable NEBM-M12G8...-V3 and interface X3 (position encoder 2) | 8106112 | NEFM-S1G9-K-0.5-R3G8 |
| Not included in the scope of delivery of the servo drive | | | |

| Ordering data – Optional accessories | | | | | | |
|------------------------------------------------------------------------------------|------------------------------------------------------------------------------------------------------------------------------------------------------------------------------|-----------------|---------------------|-------------------------------|------------------|----------------------|
| | Description | For CMMT-AS- | | | Part no. | Type |
| | | C2/C4 ...-3A | C2/C3/C5 ...-11A | C7/C12/ C18/C25 ...-11A | | |
| Blanking plate | | | | | | |
|  | <ul style="list-style-type: none"> Used to cover the connections if no operating panel is used Included in the scope of delivery of the servo drive | ■ | ■ | ■ | ★ 5395254 | CAFC-06-C |
| Shield clamp | | | | | | |
|  | <ul style="list-style-type: none"> For fitting the shield and strain relief for the motor cable Included in the scope of delivery of the servo drive | ■ | – | – | 5326867 | CAMA-C6-SK-S2 |
| | | – | ■ | – | 5335956 | CAMA-C6-SK-S3 |
| | | – | – | ■ | ★ 8114689 | CAMA-C6-SK-S4 |