

Mini guided drives DFC

FESTO

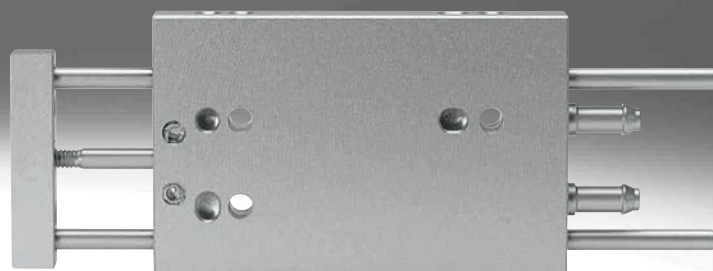

Peripherals overview

Piston \varnothing 4 mm

Piston \varnothing 6, 10 mm

Push-in fittings are integrated.

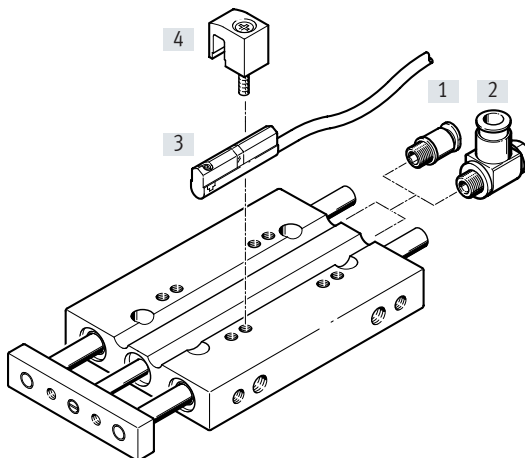
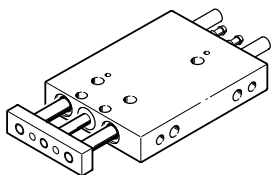

Accessories		Description	Piston \varnothing 4 mm	Piston \varnothing 6 mm	Piston \varnothing 10 mm	→ Page/Internet
[1]	Push-in fitting QSM	For connecting tubing with standard O.D.	–	■	■	qs
[2]	One-way flow control valve GRLZ	For regulating speed	–	–	■	10
[3]	Proximity switch SME/SMT-10	–	–	■	■	10
[4]	Sensor bracket	Included in the scope of delivery of the mini guide unit	–	■	■	–

Mounting options

Horizontal mounting from above

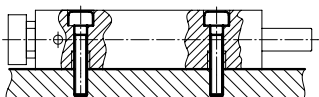

Horizontal mounting from below

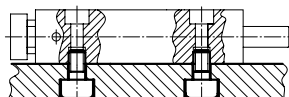

Side mounting from below

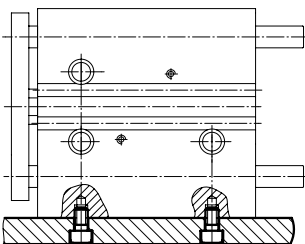

Yoke mounting

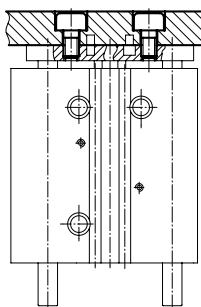

Type codes

001	Series	
DFC	Mini guided drive, double-acting	

002	Piston diameter	
4	4	
6	6	
10	10	

003	Stroke	
...	5 ... 30	

004	Cushioning	
P	Elastic cushioning rings/plates on both sides	

005	Position sensing	
	None	
A	For proximity sensor	

006	Guide	
GF	Plain bearing	
KF	Recirculating ball bearing guide	

Data sheet

Without position sensing

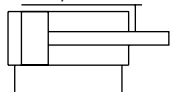

With position sensing

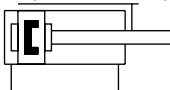

⊘ - Diameter
4, 6, 10 mm

┆ - Stroke length
5 ... 30 mm

www.festo.com

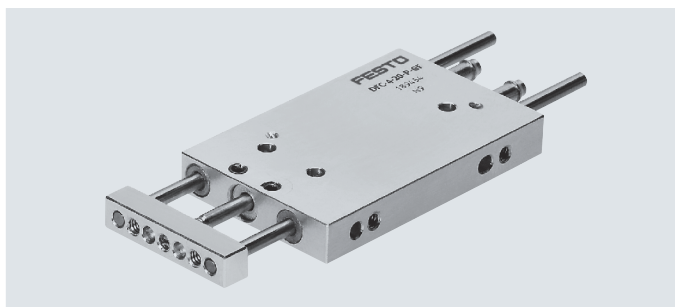

General technical data		4	6	10
Piston ∅		4	6	10
Pneumatic connection		Barbed connector PK-3 for 3 mm plastic tubing	M3	M5
Operating medium		Compressed air to ISO 8573-1:2010 [7:4:4]		
Note on operating/pilot medium		Lubricated operation possible (in which case lubricated operation will always be required)		
Operating pressure	[MPa]	0.35 ... 0.7	0.15 ... 1	0.1 ... 1
	[bar]	3.5 ... 7.0	1.5 ... 10.0	1.0 ... 10.0
Design		Piston		
		Piston rod		
		Guide rods with yoke		
Cushioning		Elastic cushioning rings/pads at both ends		
Position sensing		-	Via proximity switch	
Type of mounting		With through-hole		
		Via female thread		
Mounting position		Any		
Protection against rotation/guide		Guide rod with yoke with plain-bearing guide		Guide rod with yoke with plain-bearing or recirculating ball bearing guide

Environmental conditions		Plain-bearing guide GF	Recirculating ball bearing guide KF
Variant		Plain-bearing guide GF	Recirculating ball bearing guide KF
Ambient temperature ¹⁾	[°C]	-5 ... +60	
Corrosion resistance class CRC ²⁾		2	-

1) Note operating range of proximity switches

2) Corrosion resistance class 2 to Festo standard 940070

Components subject to moderate corrosion stress. Externally visible parts with primarily decorative surface requirements which are in direct contact with a normal industrial environment or media such as coolants or lubricating agents

Speeds [m/s] with maximum stroke length		4	6	10
Piston ∅		4	6	10
Maximum speed		1.0	1.0	1.0
Minimum speed		0.1	0.1	0.1

Forces [N]		4	6	10
Piston ∅		4	6	10
Theoretical force at 0.6 MPa (6 bar), advancing		7.5	17	47
Theoretical force at 0.6 MPa (6 bar), retracting		5.5	12.5	35

Impact energy [J]		4	6	10
Piston ∅		4	6	10
Max. impact energy at the end positions		0.006	0.008	0.05

Permissible impact velocity:

$$v = \sqrt{\frac{2 \cdot E}{m_1 + m_2}}$$

Maximum permissible mass:

$$m_2 = \frac{2 \cdot E}{v^2} - m_1$$

v Perm. impact velocity
E Max. impact energy
m₁ Moving mass (drive)
m₂ Moving payload

Note
These specifications represent the maximum values that can be achieved. The maximum permissible impact energy must be observed.

Data sheet

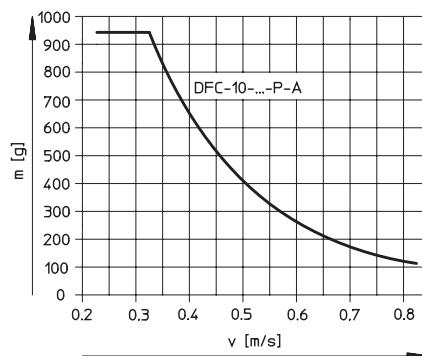
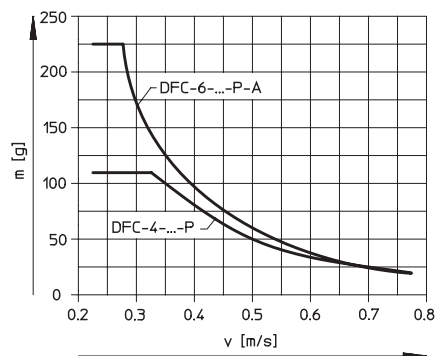
 Maximum permissible mass m as a function of the impact speed v

Weight [g]		Piston \varnothing		
		4	6	10
Product weight	with 5 mm stroke	10	28	91
	with 10 mm stroke	12	34	100
	with 15 mm stroke	15	39	108
	with 20 mm stroke	18	44	117
	with 25 mm stroke	-	49	125
	with 30 mm stroke	-	55	134
Moving mass with 0 mm stroke		3.2	8.8	27.2
Moving mass per 10 mm stroke		1.3	2.8	7.2

Materials

Sectional view

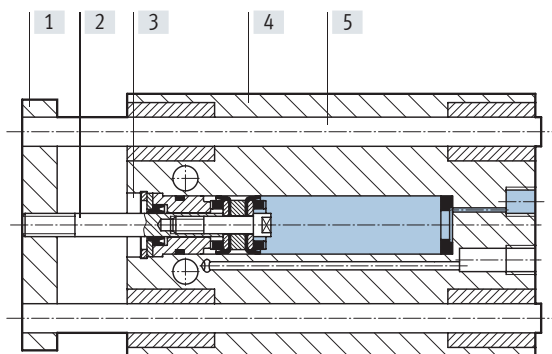

Mini guided drive	
[1] Yoke plate	Wrought aluminium alloy
[2] Piston rod	High-alloy stainless steel
[3] Cover	Wrought aluminium alloy
[4] Housing	Wrought aluminium alloy
[5] Guide rods	High-alloy steel
- Seals	Polyurethane, nitrile rubber
- PWIS conformity	VDMA24364-B2-L

Data sheet

Maximum payload F [N]

Plain-bearing guide GF and recirculating ball bearing guide KF

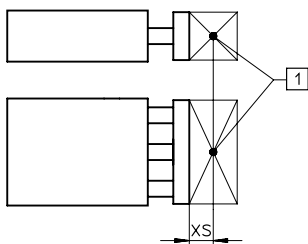

Piston diameter [mm]	XS [mm]	Stroke [mm]						
		5	10	15	20	25	30	
4	GF	5	1.7	1.7	1.7	1.7	–	–
	KF	5	–	–	–	–	–	–
6	GF	10	4.8	4.8	4.8	4.8	4.8	4.8
	KF	10	4.6	4.6	4.6	4.6	4.6	4.6
10	GF	15	12.2	12.2	12.2	12.2	12.2	12.2
	KF	15	9.8	9.8	9.8	9.8	9.8	9.8

[1] Centre of gravity of payload

Permissible torque load M [Nm]

Plain-bearing guide GF and recirculating ball bearing guide KF

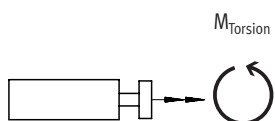

Piston diameter [mm]		Stroke [mm]					
		5	10	15	20	25	30
4	GF	0.02	0.02	0.02	0.02	–	–
	KF	–	–	–	–	–	–
6	GF	0.1	0.1	0.1	0.1	0.1	0.1
	KF	0.1	0.1	0.1	0.1	0.1	0.1
10	GF	0.4	0.4	0.4	0.4	0.4	0.4
	KF	0.3	0.3	0.3	0.3	0.3	0.3

Torsional backlash p

Plain-bearing guide GF and recirculating ball bearing guide KF

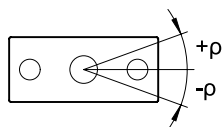

Piston ø		4	6	10
In retracted state				
Torsional backlash [°]	GF	±0.07	±0.05	±0.04
	KF	±0.07	±0.05	±0.03
In advanced state with maximum stroke				
Torsional backlash [°]	GF	±0.11	±0.07	±0.06
	KF	±0.12	±0.08	±0.05

Data sheet

Deflection of the piston rod

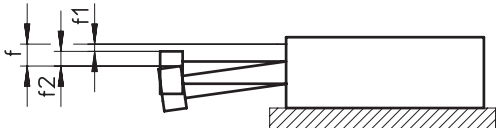

$$f = f_1 + f_2$$

f = Total deflection of the piston rod

f₁ = Deflection due to bearing backlash = max. 0.02 mm

f₂ = Deflection due to lateral force

Deflection f₂ due to lateral force F as a function of the stroke

Piston ø 4 mm

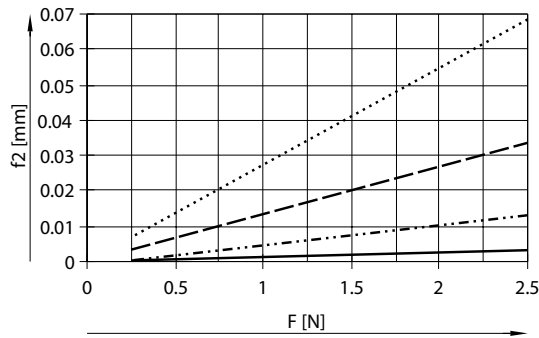

Piston ø 6 mm

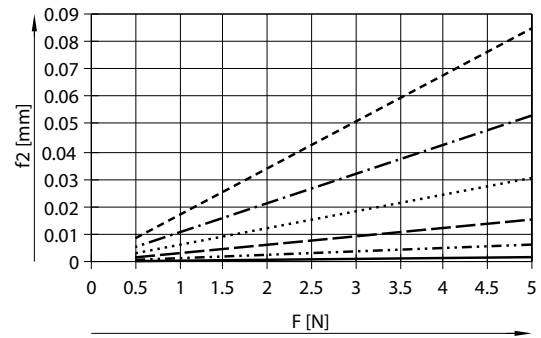

Piston ø 10 mm

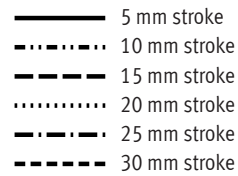
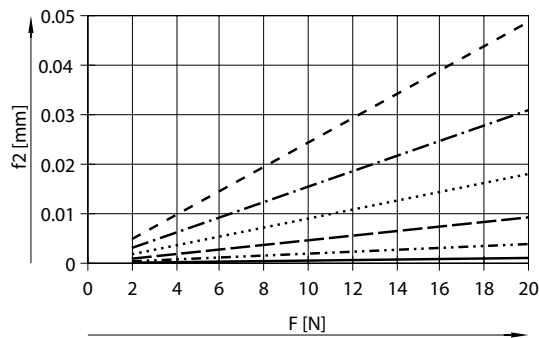

Data sheet

Dimensions

Download CAD data → www.festo.com

Basic type – Ø 4 ... 10 mm

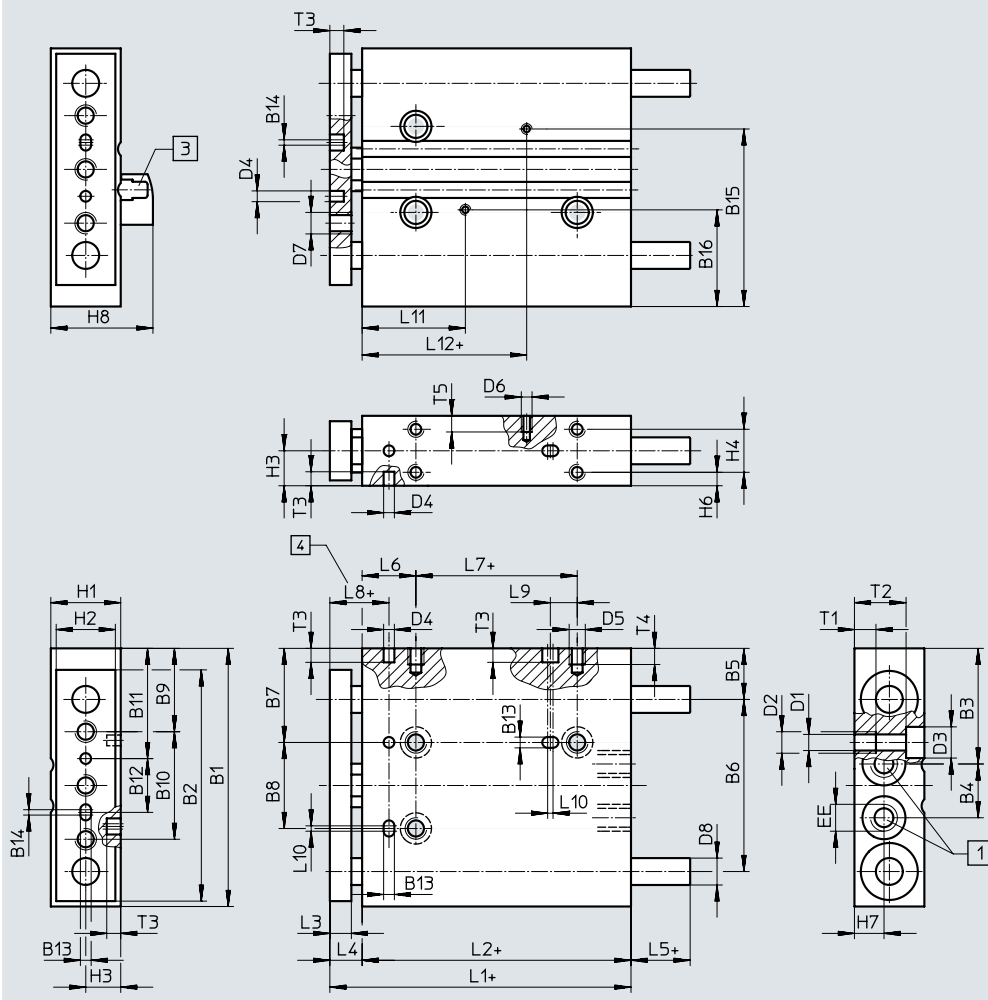

- [1] Supply ports
- [3] Sensor bracket
(included in the scope of delivery of the mini guide unit)
- [4] Dimension L8 set in advanced state

+ = plus stroke length

Deviating dimensions – Ø 4 mm

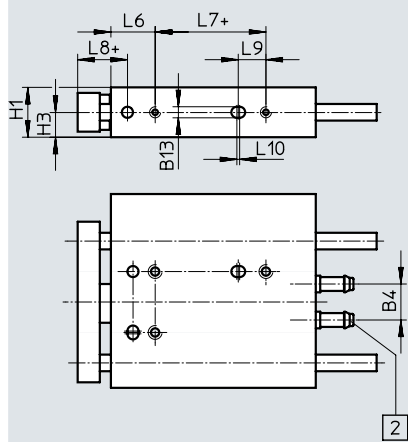

- [2] Barbed connector PK-3 for 3 mm plastic tubing

+ = plus stroke length

Data sheet

∅ [mm]	B1	B2	B3	B4	B5	B6	B7	B8	B9	B10	B11	B12	B13 H8	B14	B15	B16	D1 ∅
4	24	20	9.8	7.4	6	15	9.5	8	8.5	10	11	5	2	–	–	–	2.1
6	35	29	17	6.5	8.5	22	14	11	12	15	15.75	8	2	1	26.2	12.8	2
10	48	43	21.5	10	9.5	32	17.5	16	15.5	20	20.5	10	2	1	33	18	3.2

∅ [mm]	D2	D3 ∅	D4 ∅ H8	D5	D6 ∅	D7	D8 ∅	EE	H1	H2	H3	H4	H6	H7	H8	L1	L2
4	–	–	2	M2	–	M2	2	–	5.5	4.5	2.75	–	2.75	2.75	–	24	18
6	M2.5	4	2	M2.5	M2	M2.5	3	M3	9	7	4.5	–	4.5	3.5	15	34	27
10	M4	5.8	2	M3	M2	M4	5	M5	13	11	6.5	8	2.5	5.5	19	48	40

∅ [mm]	L3	L4 +0.3 –0.9	L5	L6	L7	L8 +0.2	L9	L10	L11	L12	T1	T2	T3	T4	T5
4	4	6	1	8	3	11	3.5	0.5	–	–	–	5.5	2	4	–
6	5	7	1	8	10	10	5	0.5	16	19.35	3	6.1	2.6	5	2.5
10	6	8	1	10	20	13	5	1	22.2	25.6	4	9.6	2.6	3	3

Ordering data

Piston ∅ [mm]	Stroke [mm]	Plain-bearing guide GF		Recirculating ball bearing guide KF	
		Part no.	Type	Part no.	Type
4	5	189479	DFC-4-5-P-GF	–	–
	10	189452	DFC-4-10-P-GF		
	15	189453	DFC-4-15-P-GF		
	20	189454	DFC-4-20-P-GF		
6	5	189455	DFC-6-5-P-A-GF ¹⁾	189461	DFC-6-5-P-A-KF ¹⁾
	10	189456	DFC-6-10-P-A-GF ¹⁾	189462	DFC-6-10-P-A-KF ¹⁾
	15	189457	DFC-6-15-P-A-GF ¹⁾	189463	DFC-6-15-P-A-KF ¹⁾
	20	189458	DFC-6-20-P-A-GF ¹⁾	189464	DFC-6-20-P-A-KF ¹⁾
	25	189459	DFC-6-25-P-A-GF ¹⁾	189465	DFC-6-25-P-A-KF ¹⁾
	30	189460	DFC-6-30-P-A-GF ¹⁾	189466	DFC-6-30-P-A-KF ¹⁾
10	5	189467	DFC-10-5-P-A-GF ¹⁾	189473	DFC-10-5-P-A-KF ¹⁾
	10	189468	DFC-10-10-P-A-GF ¹⁾	189474	DFC-10-10-P-A-KF ¹⁾
	15	189469	DFC-10-15-P-A-GF ¹⁾	189475	DFC-10-15-P-A-KF ¹⁾
	20	189470	DFC-10-20-P-A-GF ¹⁾	189476	DFC-10-20-P-A-KF ¹⁾
	25	189471	DFC-10-25-P-A-GF ¹⁾	189477	DFC-10-25-P-A-KF ¹⁾
	30	189472	DFC-10-30-P-A-GF ¹⁾	189478	DFC-10-30-P-A-KF ¹⁾

1) Mounting kits for proximity switches included in scope of delivery

Accessories



Ordering data – Proximity switch for C-slot, magneto-resistive							Data sheets → Internet: smt
	Type of mounting	Switching output	Electrical connection, outlet direction of connection	Cable length [m]	Part no.	Type	

N/O contact						
	Inserted in the slot from above	PNP	Plug M8x1, 3-pin, in-line	0.3	551375	SMT-10M-PS-24V-E-0.3-L-M8D
			Cable, 3-wire, lengthwise	2.5	551373	SMT-10M-PS-24V-E-2.5-L-OE

Ordering data – Proximity switch for C-slot, magnetic reed							Data sheets → Internet: sme
	Type of mounting	Switching output	Electrical connection, outlet direction of connection	Cable length [m]	Part no.	Type	

N/O contact						
	Insertable in the slot lengthwise	Contacting	Plug M8x1, 3-pin, in-line	0.3	173212	SME-10-SL-LED-24
			Cable, 3-wire, lengthwise	2.5	173210	SME-10-KL-LED-24

Ordering data – Connecting cables							Data sheets → Internet: nebu
	Electrical connection, left		Electrical connection, right	Cable length [m]	Part no.	Type	

	Straight socket, M8x1, 3-pin		Cable, open end, 3-wire	2.5	541333	NEBU-M8G3-K-2.5-LE3
				5	541334	NEBU-M8G3-K-5-LE3
	Angled socket, M8x1, 3-pin		Cable, open end, 3-wire	2.5	541338	NEBU-M8W3-K-2.5-LE3
				5	541341	NEBU-M8W3-K-5-LE3

Ordering data – One-way flow control valves							Data sheets → Internet: grlz
	Connection Thread		Material	Part no.	Type		

	M5	3	Metal design	193153	GRLZ-M5-QS-3-D
		4		193154	GRLZ-M5-QS-4-D
		6		193155	GRLZ-M5-QS-6-D

Festo - Your Partner in Automation



1 Festo Inc.
5300 Explorer Drive
Mississauga, ON L4W 5G4
Canada

Festo Customer Interaction Center
Tel: 1 877 463 3786
Fax: 1 877 393 3786
Email: customer.service.ca@festo.com

2 Festo Pneumatic
Av. Ceylán 3,
Col. Tequesquináhuac
54020 Tlalnepantla,
Estado de México

Multinational Contact Center
01 800 337 8669
ventas.mexico@festo.com

3 Festo Corporation
1377 Motor Parkway
Suite 310
Islandia, NY 11749

Festo Customer Interaction Center
1 800 993 3786
1 800 963 3786
customer.service.us@festo.com

4 Regional Service Center
7777 Columbia Road
Mason, OH 45040

Connect with us



www.festo.com/socialmedia



www.festo.com

Subject to change