

Mini slide DGSS

FESTO



Characteristics

At a glance

Further information → dgss

- Compact drive
- Optimum price/performance ratio
- Slide and yoke plate as a single component
- Excellent positioning accuracy
- Precise and resilient rolling bearing guide
- Operation possible without additional cushioning elements.
- Optional: stroke adjustment and external cushioning using accessories
- Very flexible thanks to wide choice of mounting and attachment options
- Simple design thanks to symmetrical mounting interface

Diagrams

Further information → dgss



The diagrams shown in this document are also available online. These can be used to display precise values.

Overview

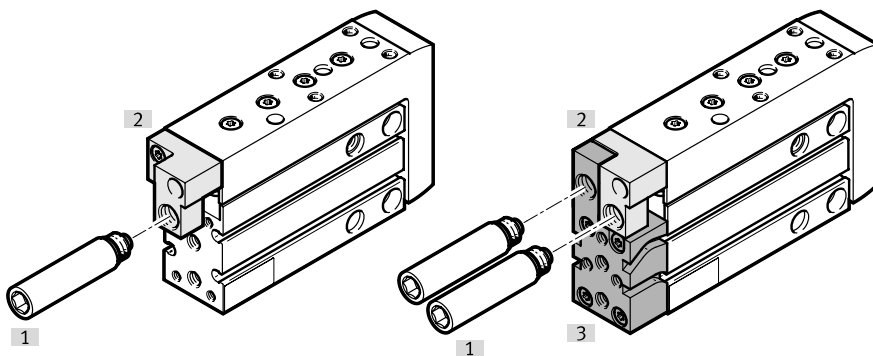

External cushioning via accessories:

- [1] Shock absorber DYEF/DYSS
- [2] Stop kit DADP-...-F
- [3] Stop kit DADP-...-R (stop kit DADP-...-F included in the scope of delivery)

Cushioning

End-position cushioning has the following functions:

- Reduces kinetic energy in the end positions
- Avoids vibrations
- Reduces noise generation

Operation possible without additional cushioning elements.

Can be operated with external cushioning components:

- Higher permissible energy (payload and speed)
- Reduced cycle times
- Easy stroke reduction possible from one side
- Precision end-position adjustment

[E1] Elastomer cushioning, double-sided, stroke not adjustable

- Standard design
- Internal cushioning, without stroke adjustment
- Elastic cushioning
- For lower cushioning energy
- Without metal fixed stop

[P] Elastic cushioning rings/plates on both sides

- External cushioning via shock absorber DYEF-G8-...-Y1, with stroke adjustment
- Elastic cushioning
- For medium cushioning energy
- Stroke reduction to the next smaller stroke is possible
- Without metal fixed stop
- Available from stroke 10 mm

Characteristics

[P1] Elastomer cushioning, adjustable on both sides, with fixed stop

- External cushioning via shock absorber DYEFG8-...-Y1F, with stroke adjustment
- Elastic cushioning
- For low to mid-range cushioning energies
- Stroke reduction to the next smaller stroke is possible
- With metal fixed stop for a very precise end position
- Available from stroke 10 mm

[E] Elastomer cushioning, short, on both sides

- External cushioning via shock absorber DYEFG8-S-...-Y1, with stroke adjustment
- Elastic cushioning
- For medium cushioning energy
- Stroke reduction, space-saving
- Without metal fixed stop
- Available from stroke 10 mm

[Y12] Shock absorber, self-adjusting, linear at both ends, external

- External cushioning via shock absorber DYSSG8-...-Y1F, with stroke adjustment
- Hydraulic cushioning
- For high cushioning energy
- Stroke reduction to the next smaller stroke is possible
- With metal fixed stop for a very precise end position
- Available from stroke 10 mm

Position sensing

[A] For proximity sensor

By using proximity switches, any position can be detected.

Special material properties

Product:

- Recommended for production systems for manufacturing lithium-ion batteries
- Metals with more than 1% copper, zinc or nickel by mass are excluded from use. Exceptions are nickel in steel, chemically nickel-plated surfaces, circuit boards, cables, electrical plug connectors and coils

Accessories:

- Please contact your Festo representative for information on which accessories are suitable for manufacturing lithium-ion batteries

Application example

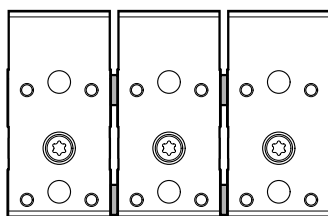

With the centring sleeves ABAZ, several mini slides can be easily mounted next to each, thus saving space. That is also how the required distance to the proximity switches is maintained and trouble-free function is guaranteed.

Type code

001	Series
DGSS	Mini slide

002	Size [mm]
6	6
10	10
16	16
20	20

003	Stroke [mm]
5	5
10	10
15	15
20	20
25	25
30	30
40	40
50	50
60	60

004	Cushioning
E1	Elastomer cushioning, double-sided, stroke not adjustable

005	Position sensing
A	For proximity sensor

Datasheet

General technical data				
Size [mm]	6	10	16	20
Piston diameter	6 mm	10 mm	16 mm	20 mm
Stroke	5 mm, 10 mm, 15 mm, 20 mm, 25 mm, 30 mm, 40 mm, 50 mm, 60 mm			
Design	Yoke Piston rod Slide			
Guide	Recirculating ball bearing guide			
Mode of operation	Double-acting			
Type of mounting	With through-hole Via female thread			
Pneumatic connection	M3	M5		
Cushioning	Elastomer cushioning, double-sided, stroke not adjustable			
Cushioning length	0.9 mm	1.5 mm	0.65 mm	1 mm
Position detection	Via proximity switch			
Mounting position	optional			
Max. speed ¹⁾	0.5 m/s			
Repetition accuracy ²⁾	≤ 0.3 mm			

- 1) DGSS-6 with cushioning -P/-E/-Y12: 0.5 m/s
 DGSS-6 with cushioning -P1: 0.45 m/s
 DGSS-10 ... 20 with cushioning -P/-E/-Y12: 0.8 m/s
 DGSS-10 ... 20 with cushioning -P1: 0.5 m/s
- 2) DGSS-6 ... 20 with cushioning -P/-E: ≤ 0.3 mm
 DGSS-6 ... 20 with cushioning -P1/-Y12: ≤ 0.01 mm

Operating and environmental conditions				
Size [mm]	6	10	16	20
Operating medium	Compressed air to ISO 8573-1:2010 [7:4:4]			
Note on operating and pilot medium	Lubricated operation possible (in which case lubricated operation will always be required)			
Operating pressure ¹⁾	0.15 ... 0.8 MPa	0.1 ... 0.8 MPa		
Operating pressure ²⁾	1.5 ... 8 bar	1 ... 8 bar		
Operating pressure ³⁾	21.75 ... 116 psi	14.5 ... 116 psi		
Ambient temperature	-10 ... 60°C			
Corrosion resistance class CRC ⁴⁾	1 - Low corrosion stress			

- 1) DGSS-6/10: The min. operating pressure may increase slightly after an idle period > 24 h.
 2) DGSS-6/10: The min. operating pressure may increase slightly after an idle period > 24 h.
 3) DGSS-6/10: The min. operating pressure may increase slightly after an idle period > 24 h.
 4) More information: www.festo.com/x/topic/crc

Forces				
Size [mm]	6	10	16	20
Theoretical force at 0.6 MPa (6 bar, 87 psi), advance stroke	17 N	47 N	121 N	188 N
Theoretical force at 0.6 MPa (6 bar, 87 psi), return stroke	13 N	39 N	104 N	158 N

Impact energy				
Size [mm]	6	10	16	20
Impact energy in end positions ¹⁾	0.01 J	0.018 J	0.03 J	0.05 J

- 1) DGSS-6 with cushioning -P/-E: 0.014 J
 DGSS-6 with cushioning -P1: 0.005 J
 DGSS-6 with cushioning -Y12: 0.06 J (energy per stroke)
 DGSS-10 with cushioning -P/-E: 0.06 J
 DGSS-10 with cushioning -P1: 0.02 J
 DGSS-10 with cushioning -Y12: 0.3 J (energy per stroke)
 DGSS-16 with cushioning -P/-E: 0.11 J
 DGSS-16 with cushioning -P1: 0.03 J
 DGSS-16 with cushioning -Y12: 0.58 J (energy per stroke)
 DGSS-20 with cushioning -P/-E: 0.21 J
 DGSS-20 with cushioning -P1: 0.04 J
 DGSS-20 with cushioning -Y12: 1.15 J (energy per stroke)

Datasheet

Impact energy for cushioning -P/-P1/-E/-E1 – Formula

$$V = \sqrt{\frac{2 \cdot E}{m_1 + m_2}}$$

$$m_2 = \frac{2 \cdot E}{v^2} - m_1$$

The specifications represent the maximum values that can be achieved. The maximum permissible impact energy must be observed.

V = permissible impact velocity

E = max. impact energy

m1 = moving mass (drive)

m2 = moving payload

Impact energy for cushioning -Y12 – formula

$$V = \sqrt{\frac{2 \cdot (E - (F + (m_1 + m_2) \cdot g \cdot \sin(\alpha)) \cdot s)}{m_1 + m_2}}$$

$$m_2 = \frac{E - F \cdot s}{\frac{1}{2} \cdot v^2 + g \cdot s \cdot \sin(\alpha)} - m_1$$

The specifications represent the maximum values that can be achieved. The maximum permissible impact energy must be observed.

V = permissible impact velocity

E = kinetic impact energy

F = cylinder force minus friction force

m1 = moving mass (drive)

m2 = moving payload

g = acceleration due to gravity

s = shock absorber stroke (values → DYSS catalogue)

a = angle of impact

v = impact velocity

Weight for DGSS-6

Size [mm]	6									
Stroke	5 mm	10 mm	15 mm	20 mm	25 mm	30 mm	40 mm	50 mm	60 mm	
Product weight	64 g	68 g	75 g	80 g	89 g	95 g	107 g	120 g	134 g	
Moving mass	27 g	28 g	31 g	32 g	36 g	37 g	41 g	46 g	51 g	

Weight for DGSS-10

Size [mm]	10									
Stroke	5 mm	10 mm	15 mm	20 mm	25 mm	30 mm	40 mm	50 mm	60 mm	
Product weight	117 g	124 g	134 g	144 g	154 g	164 g	183 g	202 g	222 g	
Moving mass	52 g	56 g	59 g	63 g	67 g	71 g	77 g	84 g	92 g	

Weights for DGSS-16

Size [mm]	16									
Stroke	5 mm	10 mm	15 mm	20 mm	25 mm	30 mm	40 mm	50 mm	60 mm	
Product weight	191 g	202 g	214 g	227 g	241 g	253 g	279 g	306 g	330 g	
Moving mass	86 g	92 g	97 g	103 g	109 g	114 g	125 g	137 g	147 g	

Weights for DGSS-20

Size [mm]	20									
Stroke	5 mm	10 mm	15 mm	20 mm	25 mm	30 mm	40 mm	50 mm	60 mm	
Product weight	379 g	389 g	407 g	432 g	450 g	477 g	513 g	564 g	600 g	
Moving mass	156 g	161 g	166 g	179 g	184 g	199 g	209 g	235 g	246 g	

Datasheet

Materials

Material cover	Wrought aluminium alloy
Material housing	Wrought aluminium alloy
Material piston rod	High-alloy stainless steel
Material guide	NBR PA High-alloy steel
Material seals	NBR PU
Note on materials	RoHS-compliant
LABS (PWIS) conformity	VDMA24364-C1-L
Suitability for the production of Li-ion batteries	Metals with more than 1% by mass of copper, zinc or nickel are excluded from use. Exceptions are nickel in steel, chemically nickel-plated surfaces, printed circuit boards, cables, electrical plug connectors and coils

Dynamic load values

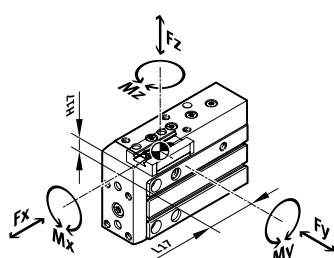

The indicated forces and torques refer to the centre of the guide. They must not be exceeded in dynamic operation. Special attention must be paid to the deceleration process.

The values for the position of the guide centre (H17, L17) can be found in the chapter Dimensions.

Dynamic load values – formula

$$f_v = \frac{|F_{y1}|}{F_{y2}} + \frac{|F_{z1}|}{F_{z2}} + \frac{|M_{x1}|}{M_{x2}} + \frac{|M_{y1}|}{M_{y2}} + \frac{|M_{z1}|}{M_{z2}} \leq 1$$

If the drive is simultaneously subjected to several of the indicated forces and torques, the following equation must be satisfied in addition to the indicated maximum loads.

f_v = load comparison factor

F1 = dynamic value

F2 = maximum value

Dynamic load values for DGSS-6

Size [mm]	6									
Stroke	5 mm	10 mm	15 mm	20 mm	25 mm	30 mm	40 mm	50 mm	60 mm	
Max. force Fy	296 N				274 N	258 N	235 N	218 N	205 N	
Max. force Fz	296 N				274 N	258 N	235 N	218 N	205 N	
Max. moment Mx	0.8 Nm				0.7 Nm		0.6 Nm			
Max. moment My	0.7 Nm				0.6 Nm				0.5 Nm	
Max. moment Mz	0.7 Nm				0.6 Nm				0.5 Nm	

Dynamic load values for DGSS-10

Size [mm]	10									
Stroke	5 mm	10 mm	15 mm	20 mm	25 mm	30 mm	40 mm	50 mm	60 mm	
Max. force Fy	826 N				766 N	721 N	655 N	608 N	572 N	
Max. force Fz	826 N				766 N	721 N	655 N	608 N	572 N	
Max. moment Mx	3 Nm				2.8 Nm	2.7 Nm	2.4 Nm	2.2 Nm	2.1 Nm	
Max. moment My	2.6 Nm				2.4 Nm	2.3 Nm	2.1 Nm	1.9 Nm	1.8 Nm	
Max. moment Mz	2.6 Nm				2.4 Nm	2.3 Nm	2.1 Nm	1.9 Nm	1.8 Nm	

Datasheet

Dynamic load values for DGSS-16

Size [mm]	16									
Stroke	5 mm	10 mm	15 mm	20 mm	25 mm	30 mm	40 mm	50 mm	60 mm	
Max. force F _y	925 N				859 N	808 N	734 N	682 N	641 N	
Max. force F _z	925 N				859 N	808 N	734 N	682 N	641 N	
Max. moment M _x	4.4 Nm				4 Nm	3.8 Nm	3.5 Nm	3.2 Nm	3 Nm	
Max. moment M _y	2.6 Nm				2.4 Nm	2.3 Nm	2.1 Nm	1.9 Nm	1.8 Nm	
Max. moment M _z	2.6 Nm				2.4 Nm	2.3 Nm	2.1 Nm	1.9 Nm	1.8 Nm	

Dynamic load values for DGSS-20

Size [mm]	20									
Stroke	5 mm	10 mm	15 mm	20 mm	25 mm	30 mm	40 mm	50 mm	60 mm	
Max. force F _y	1,560 N				1,448 N	1,363 N	1,238 N	1,149 N	1,082 N	
Max. force F _z	1,560 N				1,448 N	1,363 N	1,238 N	1,149 N	1,082 N	
Max. moment M _x	10.1 Nm				9.4 Nm	8.9 Nm	8 Nm	7.5 Nm	7 Nm	
Max. moment M _y	5.1 Nm				4.7 Nm	4.4 Nm	4 Nm	3.7 Nm	3.5 Nm	
Max. moment M _z	5.1 Nm				4.7 Nm	4.4 Nm	4 Nm	3.7 Nm	3.5 Nm	

Payload m as a function of impact velocity v and cushioning -P/-P1/-E/-E1 for DGSS-6

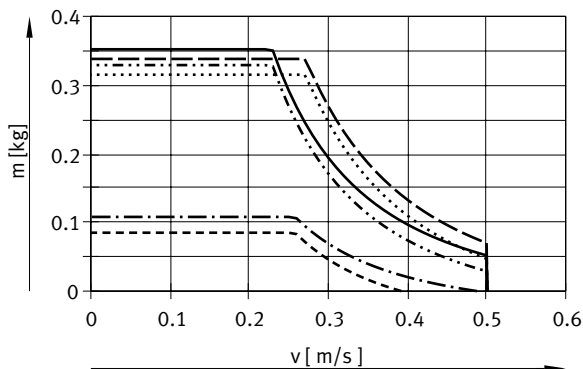

- DGSS-6-10-E1
- - - DGSS-6-60-E1
- · - DGSS-6-10-P/-E
- · · DGSS-6-60-P/-E
- - - DGSS-6-10-P1
- · - DGSS-6-30-P1

Datasheet

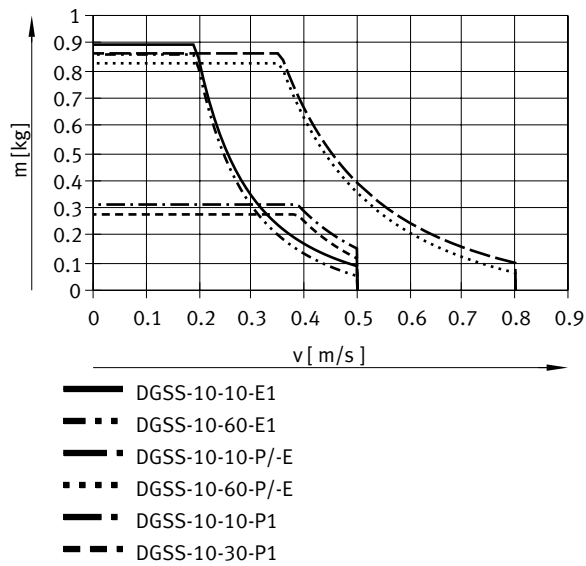
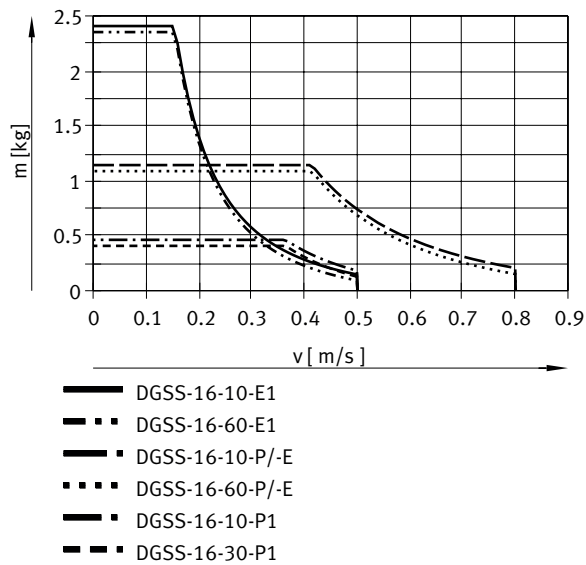
Payload m as a function of impact velocity v and cushioning -P/-P1/-E/-E1 for DGSS-10Payload m as a function of impact velocity v and cushioning -P/-P1/-E/-E1 for DGSS-16

Datasheet

Payload m as a function of impact velocity v and cushioning -P/-P1/-E/-E1 for DGSS-20

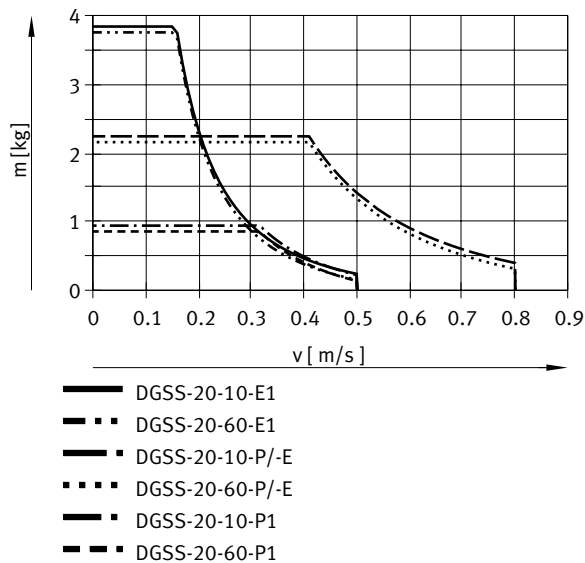

Payload m as a function of impact velocity v and cushioning -Y12 for DGSS-6

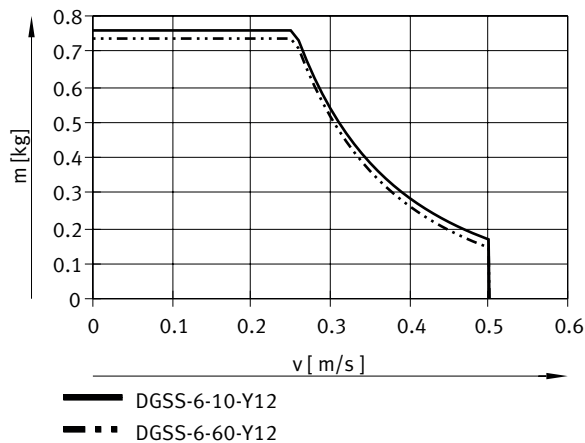

Payload m as a function of impact velocity v and cushioning -Y12 for DGSS-10

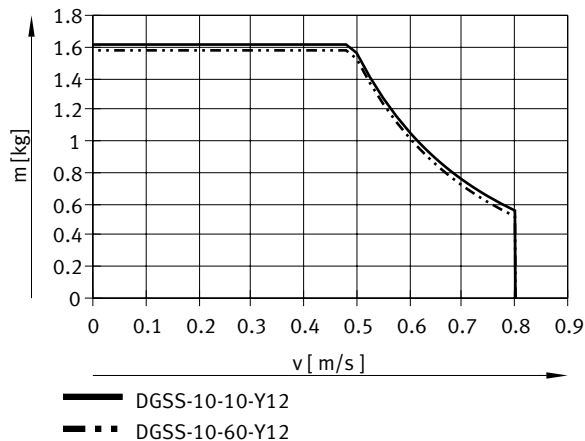

Datasheet

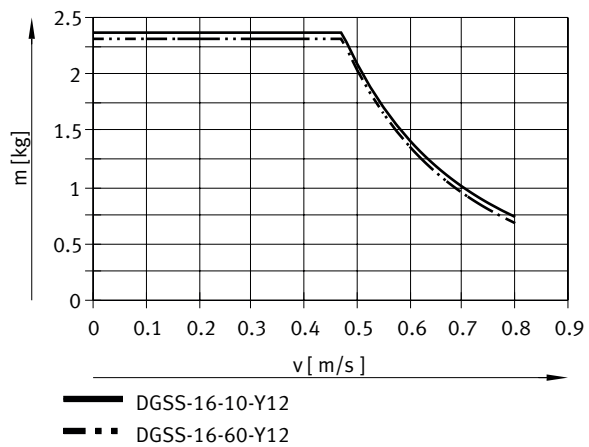
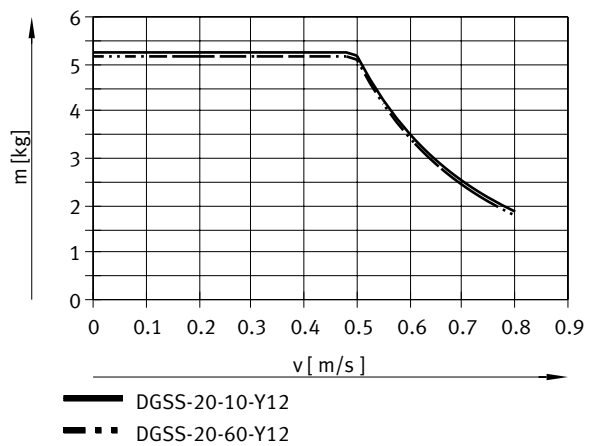
Payload m as a function of impact velocity v and cushioning -Y12 for DGSS-16Payload m as a function of impact velocity v and cushioning -Y12 for DGSS-20

Dimensions

	B1 ±0,2	B2 ±0,1	B3	B4	B5	B6	B7	B8	B9	B10	B11	B12	B13	B14	D1 ∅ H7	D2 ∅ H7	D3 ∅ H7	D4 ∅ H7
DGSS-6-5-E1A	16	15,3	10	3	10	3	-	-	9	3,2	7,7	10	3	8	5	5	5	6
DGSS-6-10-E1A																		
DGSS-6-15-E1A																		
DGSS-6-20-E1A																		
DGSS-6-25-E1A																		
DGSS-6-30-E1A																		
DGSS-6-40-E1A																		
DGSS-6-50-E1A																		
DGSS-6-60-E1A																		
DGSS-10-5-E1A	20	19,3	12,5	3,8	12,5	3,8	-	-	11	4,2	9,7	13	3,5	10	7	5	5	7,5
DGSS-10-10-E1A																		
DGSS-10-15-E1A																		
DGSS-10-20-E1A																		
DGSS-10-25-E1A																		
DGSS-10-30-E1A																		
DGSS-10-40-E1A																		
DGSS-10-50-E1A																		
DGSS-10-60-E1A																		
	D5 ∅ H7	D6	D7	D8	D9	D10	D11	D12	D13	H1	H2	H3	H4	H5	H6	H7 ±0,2	H8	H9
DGSS-6-5-E1A	5	M3	M3	M2	M4	-	M3	-	M3	39	19,5	2,5	-	5	19	38	15	7
DGSS-6-10-E1A																		
DGSS-6-15-E1A																		
DGSS-6-20-E1A																		
DGSS-6-25-E1A																		
DGSS-6-30-E1A																		
DGSS-6-40-E1A																		
DGSS-6-50-E1A																		
DGSS-6-60-E1A																		
DGSS-10-5-E1A	7	M5	M5	M2,5	M5	-	M4	-	M4	47	20,8	3,7	-	5	23	46	18	7,5
DGSS-10-10-E1A																		
DGSS-10-15-E1A																		
DGSS-10-20-E1A																		
DGSS-10-25-E1A																		
DGSS-10-30-E1A																		
DGSS-10-40-E1A																		
DGSS-10-50-E1A																		
DGSS-10-60-E1A																		

Dimensions

Dimensions – DGSS-6 ... 10-E1 (part 2 of 4)

Download CAD data → www.festo.com

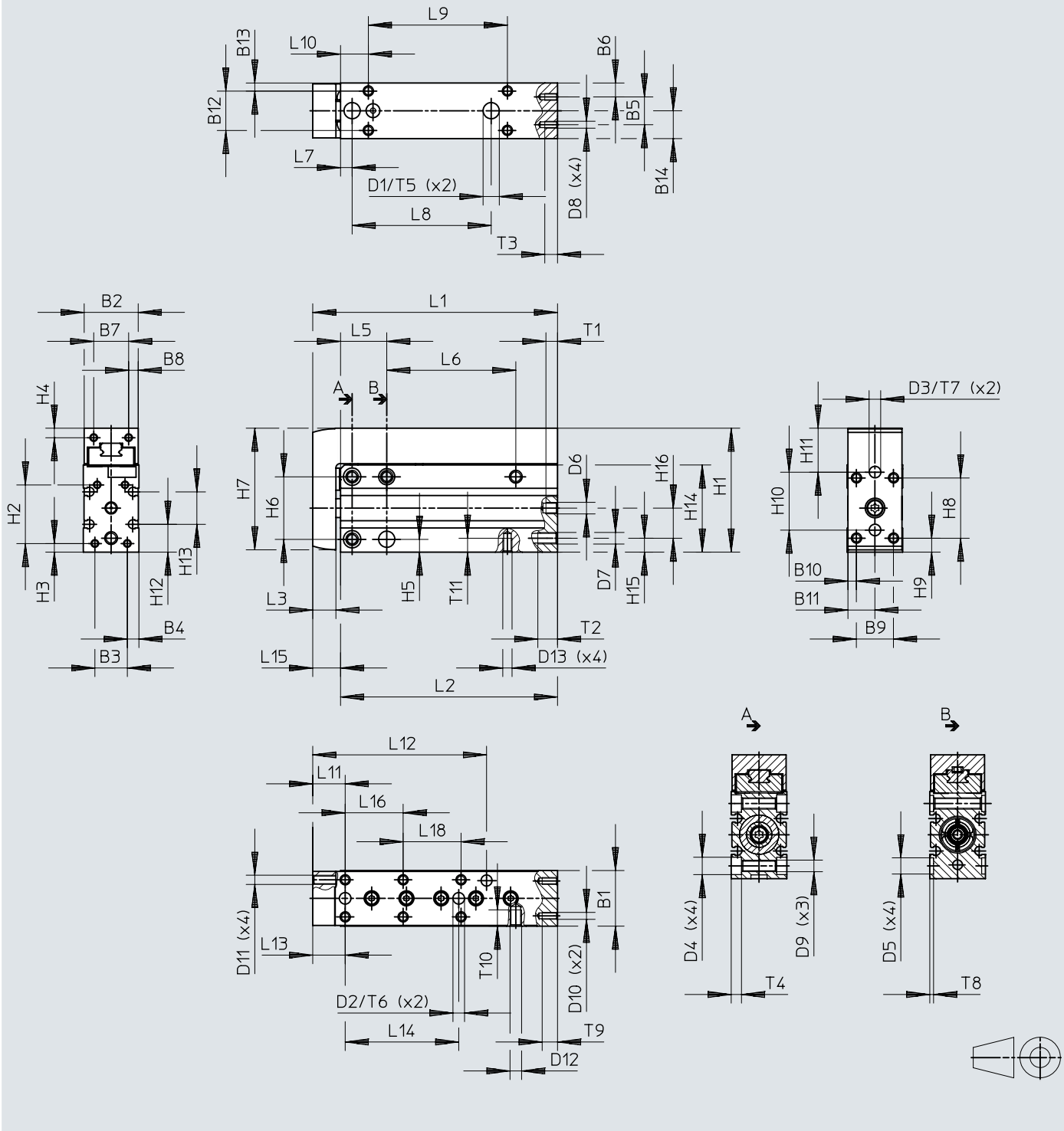

Dimensions

	H10	H11	H12	H13	H14	H15	H16	L1	L2	L3	L4	L5	L6	L7	L8	L9	L10	L11	
DGSS-6-5-E1A	18	15,5	11,2	6,6	28,2	5	10,5	42,5	34,5	6	4	12	-	3,5	20	10	10	8	
DGSS-6-10-E1A								47,5	39,5							15			
DGSS-6-15-E1A								52,5	44,5							20			
DGSS-6-20-E1A								57,5	49,5							25			
DGSS-6-25-E1A								62,5	54,5							30			30
DGSS-6-30-E1A								67,5	59,5							35			
DGSS-6-40-E1A								77,5	69,5							45			
DGSS-6-50-E1A								87,5	79,5							52,5			55
DGSS-6-60-E1A								97,5	89,5							62,5			65
DGSS-10-5-E1A								21,5	13							7			33
DGSS-10-10-E1A	56	46	15																
DGSS-10-15-E1A	61	51	20																
DGSS-10-20-E1A	66	56	25																
DGSS-10-25-E1A	71	61	30	30															
DGSS-10-30-E1A	76	66	35																
DGSS-10-40-E1A	86	76	45																
DGSS-10-50-E1A	96	86	52,5	55															
DGSS-10-60-E1A	106	96	62,5	65															

	L12	L13	L14	L15	L16	L18	T1	T2	T3	T4	T5	T6	T7	T8	T9	T10	T11
							max.	±1	max.	±0,05				±0,05	max.	max.	max.
DGSS-6-5-E1A	-	10,5	15	8	10	-	4,5	5	6	3,3	1,4	1,4	1,4	1,4	-	5,5	5
DGSS-6-10-E1A	37				20												
DGSS-6-15-E1A	41				30												
DGSS-6-20-E1A	43				20										20		
DGSS-6-25-E1A					28										25		
DGSS-6-30-E1A					43										30		
DGSS-6-40-E1A					20										30		
DGSS-6-50-E1A	25				25												
DGSS-6-60-E1A	30	30															
DGSS-10-5-E1A	-	11	16	10	10	-	6	8,5	4	4,4	1,7	1,4	1,7	1,7	-	6,2	7
DGSS-10-10-E1A	46				20												
DGSS-10-15-E1A	51				30												
DGSS-10-20-E1A	53				20										20		
DGSS-10-25-E1A					30										25		
DGSS-10-30-E1A					20										25		
DGSS-10-40-E1A					58										30		
DGSS-10-50-E1A	25				25												
DGSS-10-60-E1A	53	46	30	30													

Dimensions

Dimensions – DGSS-16 ... 20-E1 (part 3 of 4)

Download CAD data → www.festo.com

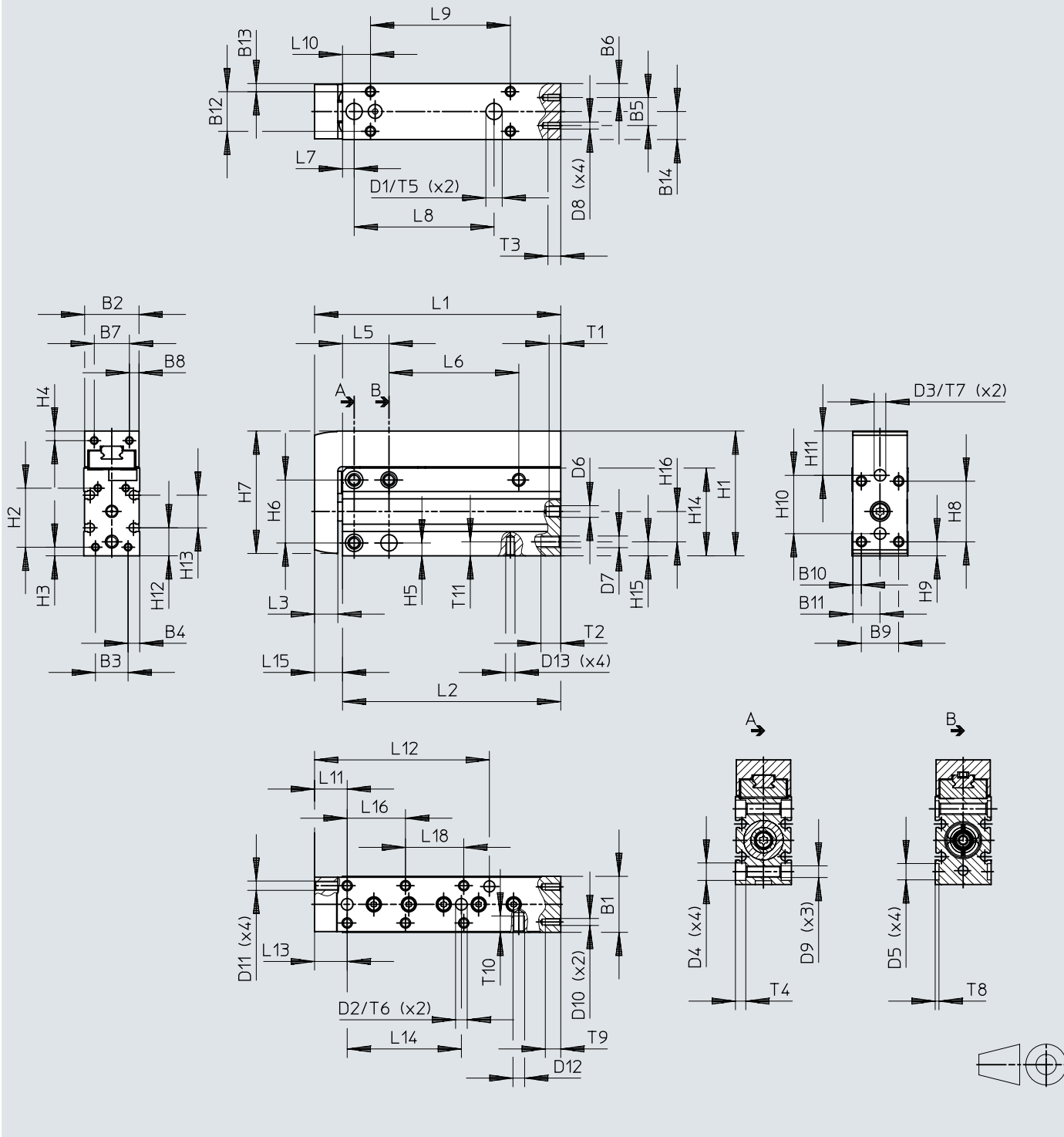

Dimensions

	B1 ±0,2	B2 ±0,1	B3	B4	B5	B6	B7	B8	B9	B10	B11	B12	B13	B14	D1 ∅ H7	D2 ∅ H7	D3 ∅ H7	D4 ∅ H7
DGSS-16-5-E1A	24	23,3	14	5	12	6	-	-	16	3,7	11,7	17	3,5	12	7	5	5	7,5
DGSS-16-10-E1A																		
DGSS-16-15-E1A																		
DGSS-16-20-E1A																		
DGSS-16-25-E1A							15,1	4,1										
DGSS-16-30-E1A																		
DGSS-16-40-E1A																		
DGSS-16-50-E1A																		
DGSS-16-60-E1A																		
DGSS-20-5-E1A	32	31,3	21,6	5,2	21,6	5,2	-	-	20	5,7	15,7	20	6	16	9	7	7	9,3
DGSS-20-10-E1A																		
DGSS-20-15-E1A																		
DGSS-20-20-E1A																		
DGSS-20-25-E1A							21,7	4,8										
DGSS-20-30-E1A																		
DGSS-20-40-E1A																		
DGSS-20-50-E1A																		
DGSS-20-60-E1A																		
	D5 ∅ H7	D6	D7	D8	D9	D10	D11	D12	D13	H1	H2	H3	H4	H5	H6	H7 ±0,2	H8	H9
DGSS-16-5-E1A	7	M5	M5	M3	M5	-	M4	-	M4	53,5	25,3	3,7	-	5,5	27	52,5	26	6
DGSS-16-10-E1A																		
DGSS-16-15-E1A																		
DGSS-16-20-E1A																		
DGSS-16-25-E1A						M3												
DGSS-16-30-E1A																		
DGSS-16-40-E1A																		
DGSS-16-50-E1A																		
DGSS-16-60-E1A																		
DGSS-20-5-E1A	9	M5	M5	M4	M6	-	M4	-	M5	64,5	26,7	5	-	6	34	63,5	34	6
DGSS-20-10-E1A																		
DGSS-20-15-E1A																		
DGSS-20-20-E1A																		
DGSS-20-25-E1A						M4												
DGSS-20-30-E1A																		
DGSS-20-40-E1A																		
DGSS-20-50-E1A																		
DGSS-20-60-E1A																		

Dimensions

Dimensions – DGSS-16 ... 20-E1 (part 4 of 4)

Download CAD data → www.festo.com

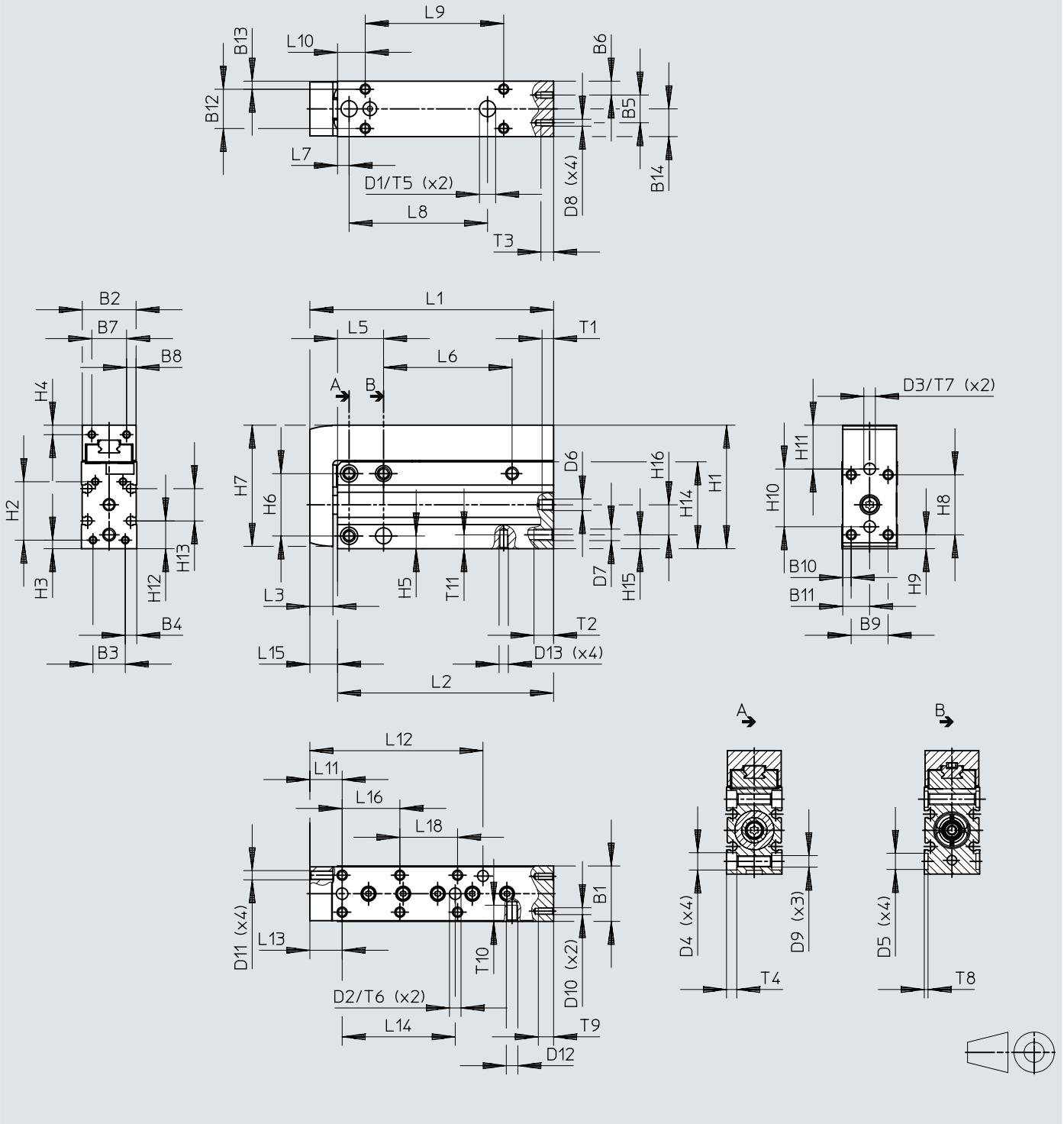

Dimensions

	H10	H11	H12	H13	H14	H15	H16	L1	L2	L3	L4	L5	L6	L7	L8	L9	L10	L11
DGSS-16-5-E1A	25	19	12	14	37,6	6	13	60,6	48,6	10	5	19,9	-	5	37	12	12	15
DGSS-16-10-E1A								65,6	53,6									20
DGSS-16-15-E1A								70,6	58,6									25
DGSS-16-20-E1A								75,6	63,6									30
DGSS-16-25-E1A								80,6	68,6									35
DGSS-16-30-E1A								85,6	73,6									40
DGSS-16-40-E1A								95,6	83,6									50
DGSS-16-50-E1A								105,6	93,6									60
DGSS-16-60-E1A								115,6	103,6									70
DGSS-20-5-E1A								34	22									17
DGSS-20-10-E1A	78	65,5	20															
DGSS-20-15-E1A	83	70,5	25															
DGSS-20-20-E1A	88	75,5	30															
DGSS-20-25-E1A	93	80,5	35															
DGSS-20-30-E1A	98	85,5	45															
DGSS-20-40-E1A	108	95,5	55															
DGSS-20-50-E1A	118	105,5	65															
DGSS-20-60-E1A	128	115,5	70															

	L12	L13	L14	L15	L16	L18	T1	T2	T3	T4	T5	T6	T7	T8	T9	T10	T11													
							max.	±1	max.	±0,05				±0,05	max.	max.	max.													
DGSS-16-5-E1A	-	14	19	12	10	-	5	8,5	5,5	4,4	1,7	1,4	1,4	1,7	-	6,6	6													
DGSS-16-10-E1A	55,8				20										-															
DGSS-16-15-E1A	60				34										20			20												
DGSS-16-20-E1A																		30	20											
DGSS-16-30-E1A																		25	25											
DGSS-16-40-E1A																		20	20											
DGSS-16-50-E1A	75				49										30			30	30											
DGSS-16-60-E1A	65																	30	30											
DGSS-20-5-E1A	-				23										12,5			-	10	5	8,5	6,5	8	2,1	1,7	1,7	2,1	-	7,5	8
DGSS-20-10-E1A	67																		20									-		
DGSS-20-15-E1A	69	41	30	20																										
DGSS-20-20-E1A				30		20																								
DGSS-20-25-E1A				20		20																								
DGSS-20-30-E1A				25		25																								
DGSS-20-40-E1A	73	59	25	20		20																								
DGSS-20-50-E1A				25		25																								
DGSS-20-60-E1A				82		30	30																							

Dimensions

Dimensions – DGSS-...-E1 perpendicularity

Download CAD data → www.festo.com

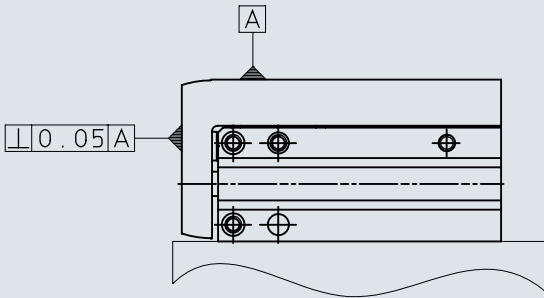

[1] The term perpendicularity refers to the alignment accuracy between the slide surface and the yoke plate.

Dimensions

Dimensions – DGSS-...-E1 parallelism

Download CAD data → www.festo.com

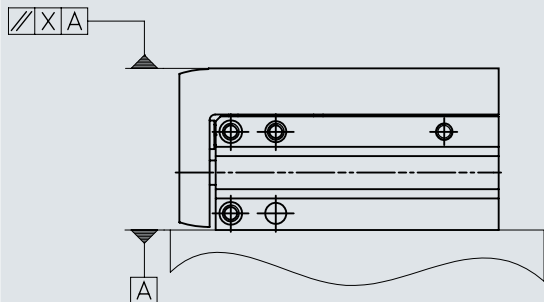

[1] The term parallelism refers to the alignment accuracy between the mounting surface and the slide surface in the longitudinal direction.

	1)
DGSS-6-5 ... 30-E1A	0,08
DGSS-6-40 ... 60-E1A	0,1
DGSS-10-5 ... 30-E1A	0,08
DGSS-10-40 ... 60-E1A	0,1
DGSS-16-5 ... 30-E1A	0,08
DGSS-16-40 ... 60-E1A	0,1
DGSS-20-5 ... 30-E1A	0,1
DGSS-20-40 ... 60-E1A	0,15

1) Parallelism

Dimensions

Dimensions – DGSS-...-E1 linearity

Download CAD data → www.festo.com

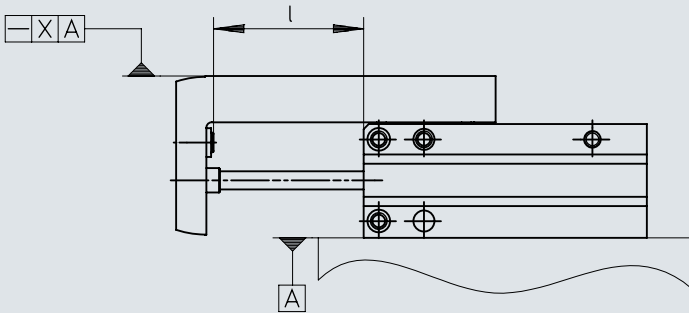

[1] l = stroke

[2] The term linearity refers to the alignment accuracy between the mounting surface and the slide surface in relation to the stroke.

	1)
DGSS-6-5 ... 30-E1A	0,035
DGSS-6-40 ... 60-E1A	0,05
DGSS-10-5 ... 30-E1A	0,035
DGSS-10-40 ... 60-E1A	0,05
DGSS-16-5 ... 30-E1A	0,035
DGSS-16-40 ... 60-E1A	0,05
DGSS-20-5 ... 30-E1A	0,035
DGSS-20-40 ... 60-E1A	0,05

1) Linearity

Dimensions

Dimensions – DGSS-...-E1 guide centre and additional stroke/cushioning stroke

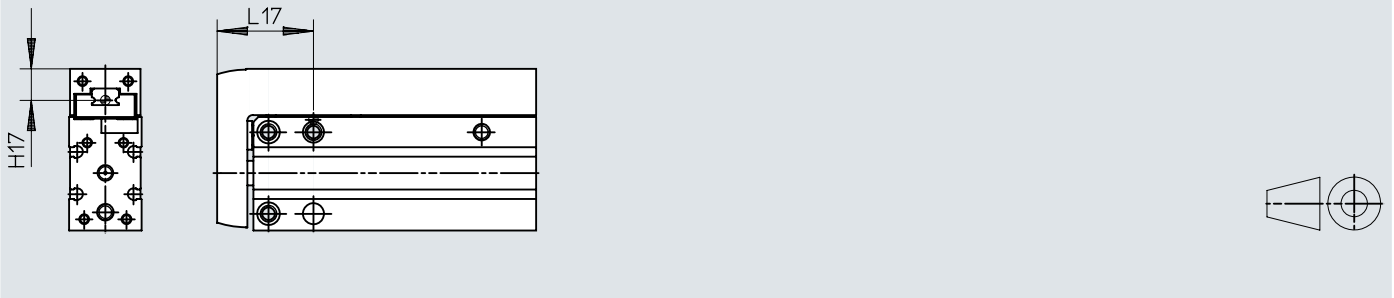
Download CAD data → www.festo.com

	H17	L17
DGSS-6-...-E1A	7,9	20
DGSS-10-...-E1A	9,6	28,1
DGSS-16-...-E1A	10,4	31,9
DGSS-20-...-E1A	10,8	35,9

	1)	2)	3)	4)
DGSS-6-...-E1A	1,85	0,7	0,9	0,25
DGSS-10-...-E1A	2,15	0,4	1,5	
DGSS-16-...-E1A	1,9	0,65	0,65	0,6
DGSS-20-...-E1A		0,4	1	0,5

- 1) Max. additional stroke = additional stroke without cushioning + max. cushioning stroke for the retracted/extended end position.
- 2) Additional stroke without cushioning. Without pressurisation and with cushioning.
- 3) Max. cushioning stroke for the retracted end position.
- 4) Max. cushioning stroke for the extended end position.

Dimensions

Dimensions – DGSS-...-E1 with stop kit DADP and shock absorber DYEF-G8-...-Y1 (cushioning -P)

Download CAD data → www.festo.com

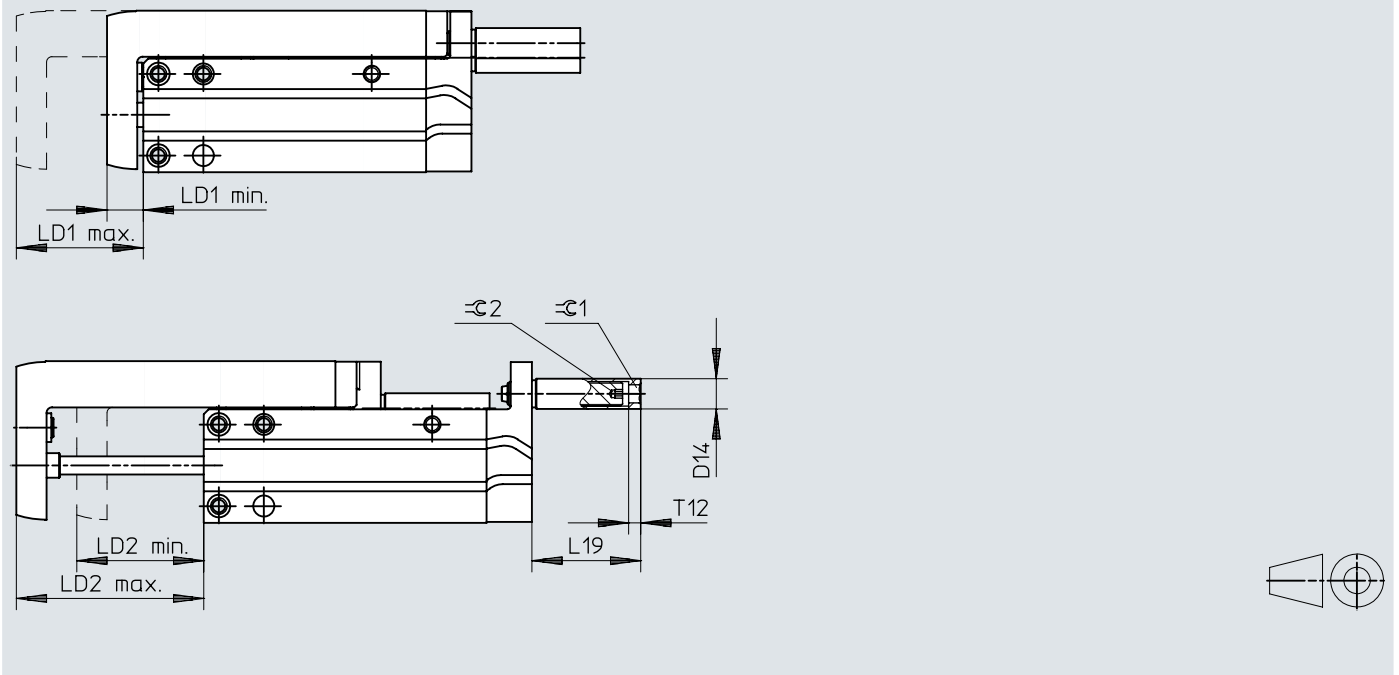

Dimensions

	D14 ∅	L19	LD1			LD2			T12	≙1	≙2
			1)	min.	max.	1)	min.	max.			
DGSS-6-10-E1A	6	22	11,7	11,7	20	9,8	8,5	18,3	2	3	1,5
DGSS-6-15-E1A							13,5	23,3			
DGSS-6-20-E1A							18,5	28,3			
DGSS-6-25-E1A							23,5	33,3			
DGSS-6-30-E1A							28,5	38,3			
DGSS-6-40-E1A							38,5	48,3			
DGSS-6-50-E1A							48,5	58,3			
DGSS-6-60-E1A							58,5	68,3			
DGSS-10-10-E1A	8	31	13,8	13,8	24,8	10	11	21	3	5	2
DGSS-10-15-E1A						15	26				
DGSS-10-20-E1A						17,3	13,7	31			
DGSS-10-25-E1A							18,7	36			
DGSS-10-30-E1A							23,7	41			
DGSS-10-40-E1A							33,7	51			
DGSS-10-50-E1A							43,7	61			
DGSS-10-60-E1A							53,7	71			
DGSS-16-10-E1A	10	36	22,4	12,4	34,7	10	12,4	22,4	4	6	2,5
DGSS-16-15-E1A							17,4	27,4			
DGSS-16-20-E1A							22,4	32,4			
DGSS-16-25-E1A							27,4	37,4			
DGSS-16-30-E1A							32,4	42,4			
DGSS-16-40-E1A							42,4	52,4			
DGSS-16-50-E1A							52,4	62,4			
DGSS-16-60-E1A							62,4	72,4			
DGSS-20-10-E1A	13	39	20,7	12,8	33,5	15	12,8	22,8	5	8	3
DGSS-20-15-E1A							27,8				
DGSS-20-20-E1A						19,1	13,7	32,8			
DGSS-20-25-E1A							18,7	37,8			
DGSS-20-30-E1A							32,8	42,8			
DGSS-20-40-E1A							33,7	52,8			
DGSS-20-50-E1A							43,7	62,8			
DGSS-20-60-E1A							53,7	72,8			

1) Setting range

Dimensions

Dimensions – DGSS-...-E1 with stop kit DADP and shock absorber DYEF-G8-...-Y1F (cushioning -P1)

Download CAD data → www.festo.com

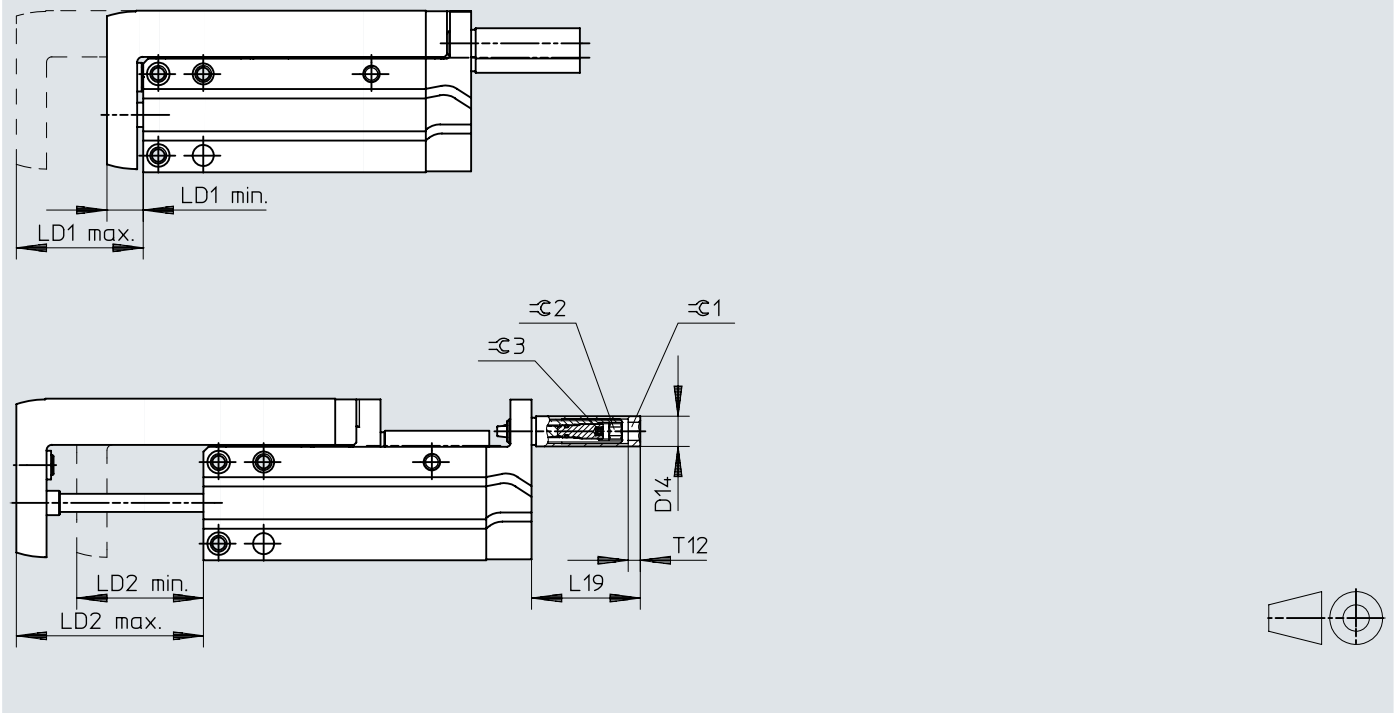

Dimensions

	D14 ∅	L19	LD1			LD2			T12	≙G1	≙G2	≙G3
			1)	min.	max.	1)	min.	max.				
DGSS-6-10-E1A	6	22	11,2	8,8	20	10	8,8	18,8	2	3	2,5	1,3
DGSS-6-15-E1A						10,3	13,5	23,8				
DGSS-6-20-E1A							18,5	28,8				
DGSS-6-25-E1A							23,5	33,8				
DGSS-6-30-E1A							28,5	38,8				
DGSS-6-40-E1A							38,5	48,8				
DGSS-6-50-E1A							48,5	58,8				
DGSS-6-60-E1A							58,5	68,8				
DGSS-10-10-E1A	8	31	13	11,5	24,5	10	11,5	21,5	3	5	4	2
DGSS-10-15-E1A						15	26,5					
DGSS-10-20-E1A						17,5	14	31,5				
DGSS-10-25-E1A							19	36,5				
DGSS-10-30-E1A							24	41,5				
DGSS-10-40-E1A							34	51,5				
DGSS-10-50-E1A							44	61,5				
DGSS-10-60-E1A							54	71,5				
DGSS-16-10-E1A	10	36	21,2	12,9	34	10	22,9	4	6	5	2,5	
DGSS-16-15-E1A							12,9					22,85
DGSS-16-20-E1A							17,5					27,5
DGSS-16-25-E1A							22,5					32,5
DGSS-16-30-E1A							32,5					42,5
DGSS-16-40-E1A							42,5					52,5
DGSS-16-50-E1A							52,5					62,5
DGSS-16-60-E1A												
DGSS-20-10-E1A	13	39	19,4	13,3	32,7	10	23,3	5	8	6	3	
DGSS-20-15-E1A						15	28,3					
DGSS-20-20-E1A						18,8	14,5					33,3
DGSS-20-25-E1A							19,5					38,3
DGSS-20-30-E1A							24,5					43,3
DGSS-20-40-E1A							34,5					53,3
DGSS-20-50-E1A							44,5					63,3
DGSS-20-60-E1A							54,5					73,3

1) Setting range

Dimensions

Dimensions – DGSS-...-E1 with stop kit DADP and shock absorber DYEF-G8-S-...-Y1 (cushioning -E)

Download CAD data → www.festo.com

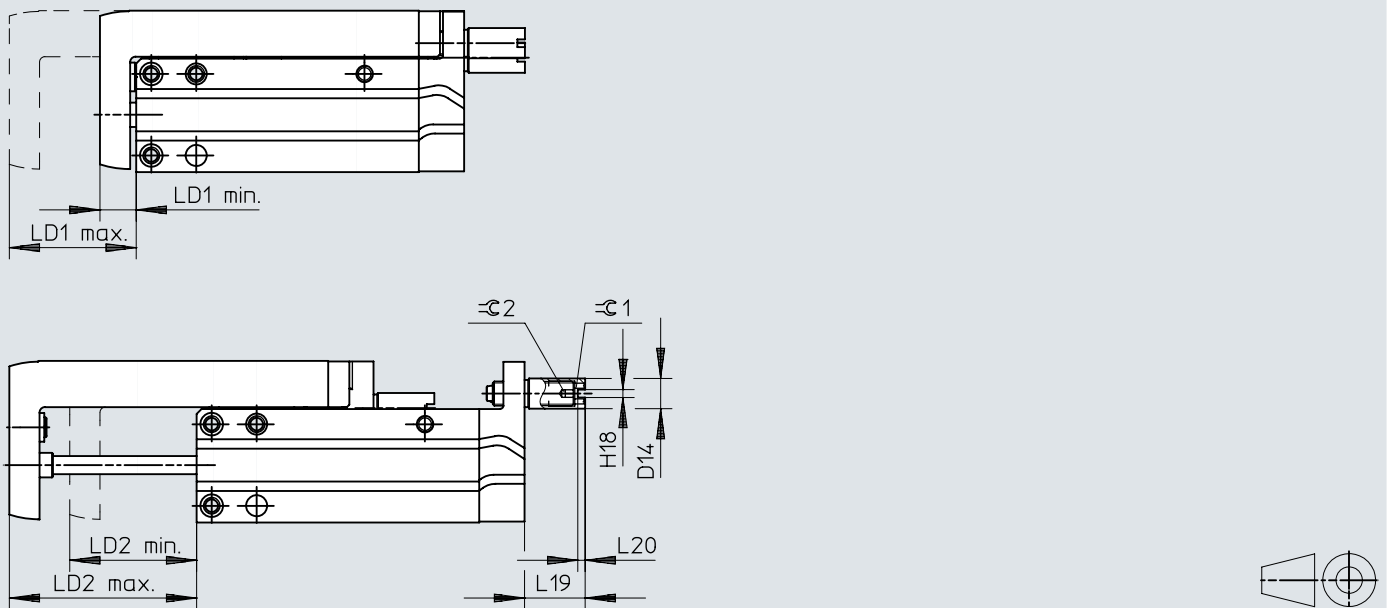

[1] Restricted nominal stroke with shock absorbers DYEF-G8-S-...-Y1 (cushioning -E).

[2] Example for DGSS-16-25: Nominal stroke = LD2max. – LD1min. = 36.3 – 15.3 = 21 mm

Dimensions

	D14 ∅	H18	L19	L20	LD1			LD2			≙G1	≙G2
					1)	min.	max.	1)	min.	max.		
DGSS-6-10-E1A	6	1,6	15,5	1,5	8,3	8,3	17	6,4	12	18,3	3	1,5
DGSS-6-15-E1A									17	23,3		
DGSS-6-20-E1A									21	28,3		
DGSS-6-25-E1A									27	33,3		
DGSS-6-30-E1A									32	38,3		
DGSS-6-40-E1A									42	48,3		
DGSS-6-50-E1A									52	58,3		
DGSS-6-60-E1A									62	68,3		
DGSS-10-10-E1A	8	2,1	16,1	2	5,3	11	16,3	6,9	12,3	19,2	5	2
DGSS-10-15-E1A									17,3	24,2		
DGSS-10-20-E1A									22,3	29,2		
DGSS-10-25-E1A									27,3	34,2		
DGSS-10-30-E1A									32,3	39,2		
DGSS-10-40-E1A									42,3	49,2		
DGSS-10-50-E1A									52,3	59,2		
DGSS-10-60-E1A									62,3	69,2		
DGSS-16-10-E1A	10	2,6	20,1	2,5	8,1	15,3	23,4	8,1	15,3	21,3	6	2,5
DGSS-16-15-E1A									18,2	26,3		
DGSS-16-20-E1A									23,2	31,3		
DGSS-16-25-E1A									28,2	36,3		
DGSS-16-30-E1A									33,2	41,3		
DGSS-16-40-E1A									43,2	51,3		
DGSS-16-50-E1A									53,2	61,3		
DGSS-16-60-E1A									63,2	71,3		
DGSS-20-10-E1A	13	3,1	21,4	3	6,9	15,1	21,9	7,4	15,3	22,7	8	3
DGSS-20-15-E1A									20,3	27,7		
DGSS-20-20-E1A									25,3	32,7		
DGSS-20-25-E1A									30,3	37,7		
DGSS-20-30-E1A									35,3	42,7		
DGSS-20-40-E1A									45,3	52,7		
DGSS-20-50-E1A									55,3	62,7		
DGSS-20-60-E1A									65,3	72,7		

1) Setting range

Dimensions

Dimensions – DGSS-...-E1 with stop kit DADP and shock absorber DYSS-G8-...-Y1F (cushioning -Y12)

Download CAD data → www.festo.com

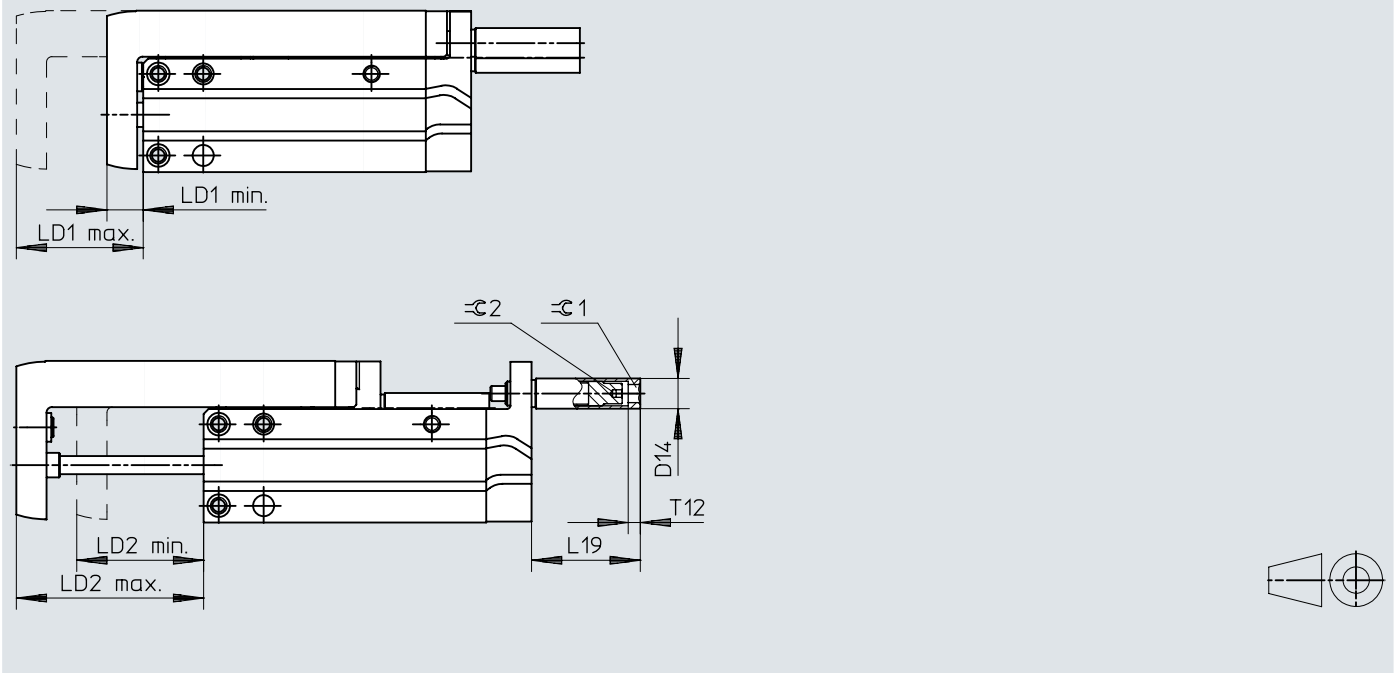

Dimensions

	D14 ∅	L19	LD1			LD2			T12	≙1	≙2
			1)	min.	max.	1)	min.	max.			
DGSS-6-10-E1A	6	22	9,3	8,8	18,1	8,4	10,4	18,8	2	3	-
DGSS-6-15-E1A							15,4	23,8			
DGSS-6-20-E1A							20,4	28,8			
DGSS-6-25-E1A							25,4	33,8			
DGSS-6-30-E1A							30,4	38,8			
DGSS-6-40-E1A							40,4	48,8			
DGSS-6-50-E1A							50,4	58,8			
DGSS-6-60-E1A							60,4	68,8			
DGSS-10-10-E1A	8	31	12,5	11,5	24	10	11,5	21,5	3	5	2
DGSS-10-15-E1A						15	26,5				
DGSS-10-20-E1A						17	14,5	31,5			
DGSS-10-25-E1A							19,5	36,5			
DGSS-10-30-E1A							24,5	41,5			
DGSS-10-40-E1A							34,5	51,5			
DGSS-10-50-E1A							44,5	61,5			
DGSS-10-60-E1A							54,5	71,5			
DGSS-16-10-E1A	10	36	15,8	12,9	28,6	10	12,9	22,9	4	6	2,5
DGSS-16-15-E1A							17,9	27,9			
DGSS-16-20-E1A							22,9	32,9			
DGSS-16-25-E1A							27,9	37,9			
DGSS-16-30-E1A							32,9	42,9			
DGSS-16-40-E1A							42,9	52,9			
DGSS-16-50-E1A							52,9	62,9			
DGSS-16-60-E1A							62,9	72,9			
DGSS-20-10-E1A	13	39	13,6	13,3	26,9	10	13,3	23,3	5	8	3
DGSS-20-15-E1A						15	28,3				
DGSS-20-20-E1A						13	15,3	33,3			
DGSS-20-25-E1A							20,3	38,3			
DGSS-20-30-E1A							25,3	43,3			
DGSS-20-40-E1A							30,3	53,3			
DGSS-20-50-E1A							40,3	63,3			
DGSS-20-60-E1A							50,3	63,3			

1) Setting range

Dimensions

Dimensions – Stop kit DADP-SP-G9-...-F

Download CAD data → www.festo.com

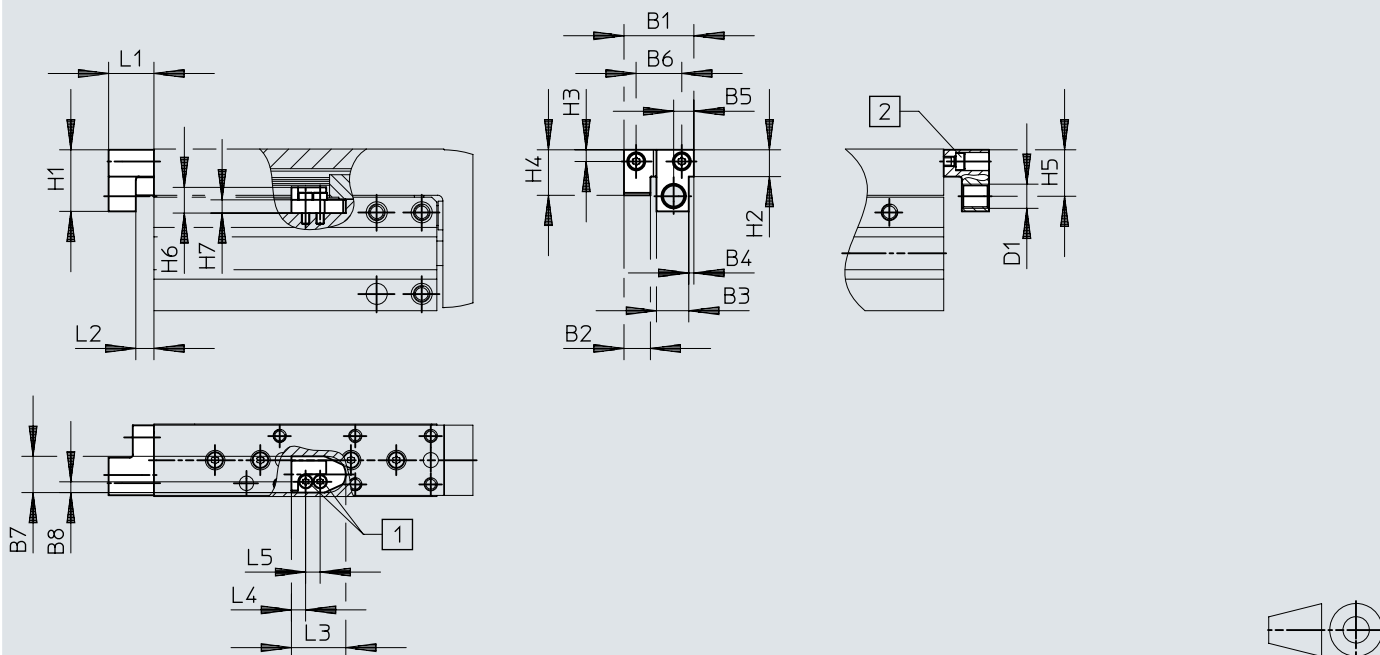

[1] DADP-SP-G9-6-F: M2x6 screw / DADP-SP-G9-10-F: M2.5x8 screw / DADP-SP-G9-16-F: M2.5x8 screw / DADP-SP-G9-20-F: M3x12 screw

[2] DADP-SP-G9-6-F: M2x8 screw / DADP-SP-G9-10-F: M2.5x10 screw / DADP-SP-G9-16-F: M3x10 screw / DADP-SP-G9-20-F: M4x10 screw

	B1	B2	B3	B4	B5	B6	B7	B8	D1	H1	H2
	-0,1						-0,05				
DADP-SP-G9-6-F	15,1	–	6,4	1,4	4,4	9,9	8	2,1	M4x0,5	14	7,2
DADP-SP-G9-10-F	19,1	7,7	8,1	1,5	5,6	12	9,6	2,6	M6x0,5	18,2	9,2
DADP-SP-G9-16-F	23,1	8,7	10,7	1,7	6,7	15,1	12	3,6	M8x1	20,4	8,9
DADP-SP-G9-20-F	31,1	13	13,4	2,8	9,5	21,7	15		M10x1	27,1	13,2

	H3	H4	H5	H6	H7	L1	L2	L3	L4	L5
				-0,1	-0,1					
DADP-SP-G9-6-F	2,6	10	11	5,2	3,2	11	4	13	3,5	4
DADP-SP-G9-10-F	3,4	13,2	14,3	7,2	4,3	17	10,5	15,3	4,5	4,8
DADP-SP-G9-16-F	3,9	15,1	15,4	8,5	4,4	15	6	18	4,7	
DADP-SP-G9-20-F	4,6	17,4	20,4	13	7,4	20,5	9	22	9	6

Dimensions

Dimensions – Stop kit DADP-SP-G9-...-R

Download CAD data → www.festo.com

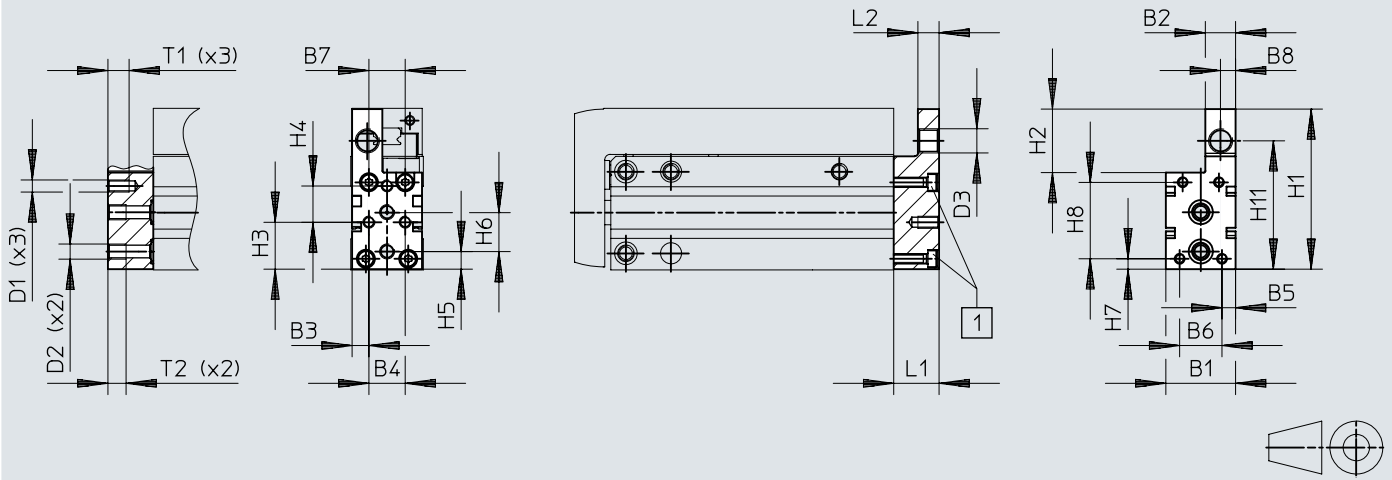

[1] DADP-SP-G9-6-R: M2x14 screw / DADP-SP-G9-10-R: M2.5x18 screw / DADP-SP-G9-16-R: M3x16 screw / DADP-SP-G9-20-R: M4x22 screw

	B1	B2	B3	B4	B5	B6	B7	B8	D1	D2	D3	H1
	-0,1	-0,1										-0,1
DADP-SP-G9-6-R	15,1	6,8	2,5	10,1	2,6	10	10	3,4	M3	M3	M4x0,5	38,4
DADP-SP-G9-10-R	19,1	8,7	3	13	3,3	12,5	12,5	4,3			M6x0,5	46,6
DADP-SP-G9-16-R	23,1	10	5,6	12	4,6	14	12	5	M4	M5	M8x1	52,9
DADP-SP-G9-20-R	31	14,1	7	17	4,7	21,6	17	7,3			M5	M10x1

	H2	H3	H4	H5	H6	H7	H8	H11	L1	L2	T1	T2
											max.	max.
DADP-SP-G9-6-R	14,5	12,2	8,5	4,7	10,5	2,2	19,5	31,4	11	5	4	5
DADP-SP-G9-10-R	18,7	9	15		11,5	3,4	20,8	37,7	17	8,5		6
DADP-SP-G9-16-R	21	15,5	12	5,8	13	25,3	42,4	15	7			
DADP-SP-G9-20-R	27,9	16	16	6,7	16	4,7	26,7	52	20,5	9,8		8

Dimensions

Dimensions – Centring sleeve ABAZ-G9-HD

Download CAD data → www.festo.com

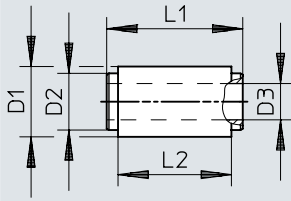

	D1 ∅ ±0,1	D2 ∅ g8	D3 ∅ ±0,1	L1 ±0,1	L2 ±0,1
ABAZ-G9-HD-6	7	6	3,8	12	10
ABAZ-G9-HD-10	9,3	7,5	4,8	18	15
ABAZ-G9-HD-20	11,3	9,3	5,8		

Ordering data

Ordering data					
	Size	Stroke	Cushioning	Part no.	Type
	6	5 mm	Elastomer cushioning, double-sided, stroke not adjustable	8164050	DGSS-6-5-E1A
		10 mm		8164051	DGSS-6-10-E1A
		15 mm		8164052	DGSS-6-15-E1A
		20 mm		8164053	DGSS-6-20-E1A
		25 mm		8164054	DGSS-6-25-E1A
		30 mm		8164055	DGSS-6-30-E1A
		40 mm		8164056	DGSS-6-40-E1A
		50 mm		8164057	DGSS-6-50-E1A
		60 mm		8164058	DGSS-6-60-E1A
	10	5 mm	8164059	DGSS-10-5-E1A	
		10 mm	8164060	DGSS-10-10-E1A	
		15 mm	8164061	DGSS-10-15-E1A	
		20 mm	8164062	DGSS-10-20-E1A	
		25 mm	8164063	DGSS-10-25-E1A	
		30 mm	8164064	DGSS-10-30-E1A	
		40 mm	8164065	DGSS-10-40-E1A	
		50 mm	8164066	DGSS-10-50-E1A	
		60 mm	8164067	DGSS-10-60-E1A	
	16	5 mm	8164068	DGSS-16-5-E1A	
		10 mm	8164069	DGSS-16-10-E1A	
		15 mm	8164070	DGSS-16-15-E1A	
		20 mm	8164071	DGSS-16-20-E1A	
		25 mm	8164072	DGSS-16-25-E1A	
		30 mm	8164073	DGSS-16-30-E1A	
		40 mm	8164074	DGSS-16-40-E1A	
		50 mm	8164075	DGSS-16-50-E1A	
		60 mm	8164076	DGSS-16-60-E1A	
	20	5 mm	8164077	DGSS-20-5-E1A	
		10 mm	8164078	DGSS-20-10-E1A	
		15 mm	8164079	DGSS-20-15-E1A	
		20 mm	8164080	DGSS-20-20-E1A	
		25 mm	8164081	DGSS-20-25-E1A	
		30 mm	8164082	DGSS-20-30-E1A	
		40 mm	8164083	DGSS-20-40-E1A	
		50 mm	8164084	DGSS-20-50-E1A	
		60 mm	8164085	DGSS-20-60-E1A	

Peripherals

Peripherals overview

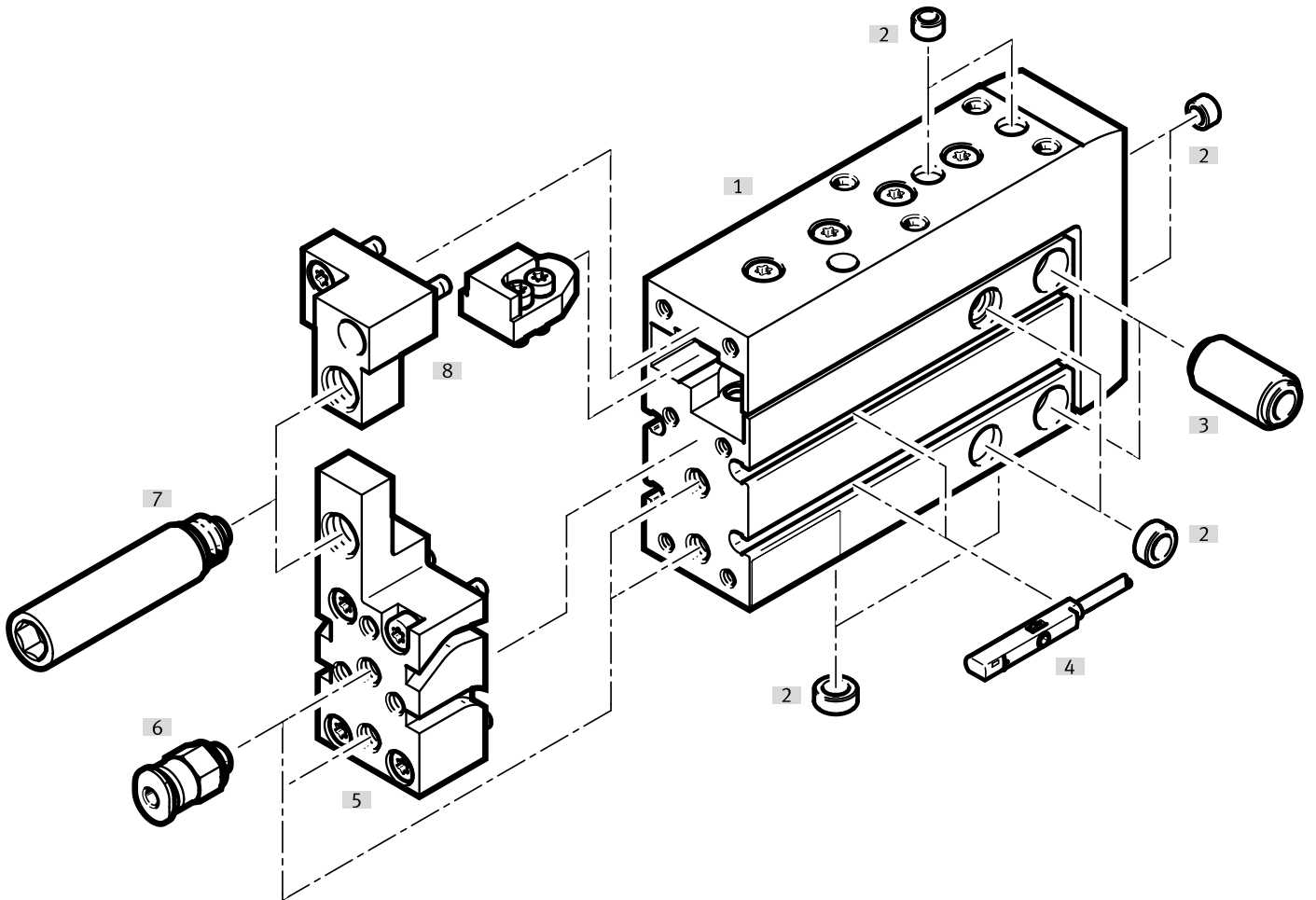

Accessories		→ Page/Internet
Type/order code	Description	
[1] Mini slide DGSS	Compact version	dgss
[2] Centring sleeve ZBH	<ul style="list-style-type: none"> For centring loads and attachments Centring sleeves are not in the scope of delivery of the mini slide 	41
[3] Centring sleeve ABAZ	For mounting several mini slides next to each other	40
[4] Proximity switch SMT-10M	<ul style="list-style-type: none"> For round slot For position sensing 	38
[4] Proximity switch SMT-10G	<ul style="list-style-type: none"> For round slot For position sensing 	39
[5] Stop kit DADP-...-R	<ul style="list-style-type: none"> For mounting shock absorbers For cushioning the extended and retracted end position Stop kit DADP-...-F included in the scope of delivery 	39
[6] Push-in fitting QSM	For connecting tubing with standard O.D	38
[6] One-way flow control valve GRLA	For regulating speed	38
[7] Shock absorber DYEF-G8-...-Y1	<ul style="list-style-type: none"> Cushioning -P For cushioning the end positions Elastic cushioning rings/pads at both ends without metal fixed stop Threaded sleeve included in the scope of delivery 	40
[7] Shock absorber DYEF-G8-S-...-Y1	<ul style="list-style-type: none"> Cushioning -E For cushioning the end positions Elastic cushioning rings/pads at both ends without metal fixed stop Short design Threaded sleeve included in the scope of delivery 	40
[7] Shock absorber DYSS-G8-...-Y1F	<ul style="list-style-type: none"> Cushioning -Y12 For cushioning the end positions Self-adjusting, hydraulic Threaded sleeve included in the scope of delivery 	40

Peripherals

Accessories		→ Page/Internet
Type/order code	Description	
[7] Shock absorber DYEFG8-...Y1F	<ul style="list-style-type: none"> • Cushioning P1 • For cushioning the end positions • Elastic cushioning rings/pads at both ends with metal fixed stop • Threaded sleeve included in the scope of delivery 	40
[8] Stop kit DADP-...F	<ul style="list-style-type: none"> • For mounting shock absorbers • For cushioning the extended end position 	39

Accessories

Push-in fitting QSM

	Pneumatic connection 1	Pneumatic connection, port 2	Note on materials	Product weight	Part no.	Type
	Male thread M3	For tubing outer diameter of 3 mm	RoHS-compliant	1.1 g	153301	QSM-M3-3
	Male thread M5			3.4 g	153302	QSM-M5-3
		For tubing outside diameter of 4 mm		3.2 g	★ 153304	QSM-M5-4
		For tubing outside diameter of 6 mm		4.5 g	★ 153306	QSM-M5-6

Push-in fitting QSM-...-I

	Pneumatic connection 1	Pneumatic connection, port 2	Note on materials	Product weight	Part no.	Type
	Male thread M3	For tubing outer diameter of 3 mm	RoHS-compliant	2.3 g	133001	QSM-M3-3-I-R
		For tubing outside diameter of 4 mm		2.2 g	133002	QSM-M3-4-I-R
	Male thread M5	For tubing outer diameter of 3 mm		3.2 g	153313	QSM-M5-3-I
		For tubing outside diameter of 4 mm		3 g	★ 153315	QSM-M5-4-I
		For tubing outside diameter of 6 mm		4.4 g	★ 153317	QSM-M5-6-I

One-way flow control valve GRLA

	Pneumatic connection, port 2	Pneumatic connection 1	Note on materials	Product weight	Part no.	Type
	M3	Push-in connector 3 mm	RoHS-compliant	7 g	175041	GRLA-M3-QS-3
	M5			13 g	★ 193137	GRLA-M5-QS-3-D
		Push-in connector 4 mm		★ 193138	GRLA-M5-QS-4-D	
		Push-in connector 6 mm		★ 193139	GRLA-M5-QS-6-D	

Proximity switch SMT-10M for round slot, magneto-resistive

Further information → smt

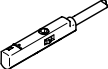
	Type of mounting	Switching output	Electrical connection	Cable length	Part no.	Type
	Screw-clamped, Insertable in the slot from above	3-wire NPN N/O contact	Open end	2.5 m	★ 551377	SMT-10M-NS-24V-E-2,5-L-OE
			Plug M8, A-coded	0.3 m	★ 551379	SMT-10M-NS-24V-E-0,3-L-M8D
		3-wire PNP N/O contact	Open end	2.5 m	★ 551373	SMT-10M-PS-24V-E-2,5-L-OE
			Plug M8, A-coded	0.3 m	★ 551375	SMT-10M-PS-24V-E-0,3-L-M8D
		2-wire PNP N/O contact	Open end	2.5 m	★ 551382	SMT-10M-ZS-24V-E-2,5-L-OE

Accessories

Proximity switch SMT-10G for round slot, magneto-resistive						Further information → smt
	Type of mounting	Switching output	Electrical connection	Cable length	Part no.	Type
	Clamped in C-slot, Insertable in the slot lengthwise	3-wire NPN N/O contact	Open end	2.5 m	8065030	SMT-10G-NS-24V-E-2,5Q-OE
			Plug M8, A-coded	0.3 m	8065029	SMT-10G-NS-24V-E-0,3Q-M8D
		3-wire PNP N/O contact	Open end	2.5 m	547862	SMT-10G-PS-24V-E-2,5Q-OE
			Plug M8, A-coded	0.3 m	547863	SMT-10G-PS-24V-E-0,3Q-M8D

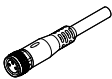
Connecting cables NEBU, straight						
	Electrical connection 1, connector system	Electrical connection 2, connector system	Electrical connection 2, number of connections/cores	Cable length	Part no.	Type
	M8x1, A-coded, to EN 61076-2-104	Open end	3	2.5 m	★ 541333	NEBU-M8G3-K-2.5-LE3
				5 m	★ 541334	NEBU-M8G3-K-5-LE3

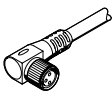
Connecting cables NEBU, angled						
	Electrical connection 1, connector system	Electrical connection 2, connector system	Electrical connection 2, number of connections/cores	Cable length	Part no.	Type
	M8x1, A-coded, to EN 61076-2-104	Open end	3	2.5 m	★ 541338	NEBU-M8W3-K-2.5-LE3
				5 m	★ 541341	NEBU-M8W3-K-5-LE3

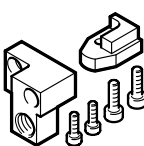
Stop kit DADP-...-F						
	Size	Material stops	Note on materials	Product weight	Part no.	Type
	6	High-alloy steel	RoHS-compliant	12 g	8173536	DADP-SP-G9-6-F
	10			27 g	8173537	DADP-SP-G9-10-F
	16			36 g	8173538	DADP-SP-G9-16-F
	20			87 g	8173539	DADP-SP-G9-20-F

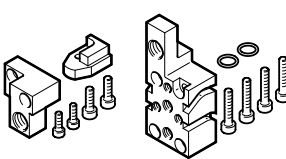
Stop kit DADP-...-R						
	Size ¹⁾	Material plate	Note on materials	Product weight	Part no.	Type
	6	Anodised wrought aluminium alloy	RoHS-compliant	24 g	8173532	DADP-SP-G9-6-R
	10			52 g	8173533	DADP-SP-G9-10-R
	16			68 g	8173534	DADP-SP-G9-16-R
	20			160 g	8173535	DADP-SP-G9-20-R

1) Scope of delivery: DADP-...-R and DADP-...-F stop kits

Shock absorber DYEF-G8-...-Y1 (cushioning -P)						
	Description ¹⁾	Cushioning	Material housing	Product weight	Part no.	Type
	For size 6	Elastic cushioning rings/pads at both ends without metal fixed stop	High-alloy steel	5 g	★ 8073902	DYEF-G8-M4-Y1

Accessories

Shock absorber DYEFG8...Y1 (cushioning -P)

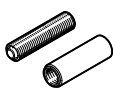
	Description ¹⁾	Cushioning	Material housing	Product weight	Part no.	Type
	For size 6	Elastic cushioning rings/pads at both ends without metal fixed stop	High-alloy steel	5 g	8131070	DYEF-G8-M4-Y1-F1A
	For size 10			11.7 g	★ 8073904	DYEF-G8-M6-Y1
					8131072	DYEF-G8-M6-Y1-F1A
	For size 16			23 g	★ 8073905	DYEF-G8-M8-Y1
	For size 20		41 g	★ 8073906	DYEF-G8-M10-Y1	
					8131074	DYEF-G8-M10-Y1-F1A

1) Scope of delivery: 1 cushioning component and 1 threaded sleeve

DYEF...-F1A: Recommended for production facilities for manufacturing lithium-ion batteries. More information: www.festo.com/x/topic/bat

Shock absorber DYEFG8...Y1F (cushioning -P1)

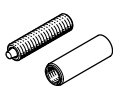
	Description ¹⁾	Cushioning	Material housing	Product weight	Part no.	Type
	For size 6	Elastic cushioning rings/pads at both ends with metal fixed stop	High-alloy steel	4.5 g	8160234	DYEF-G8-M4-Y1F
	For size 10			10.8 g	8160236	DYEF-G8-M6-Y1F
	For size 16			20.9 g	8160237	DYEF-G8-M8-Y1F
	For size 20			37.6 g	8160238	DYEF-G8-M10-Y1F

1) Scope of delivery: 1 cushioning component and 1 threaded sleeve

Shock absorber DYEFG8-S...Y1 (cushioning -E)

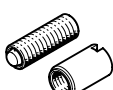
	Description ¹⁾	Cushioning	Material housing	Product weight	Part no.	Type
	For size 6	Elastic cushioning rings/pads at both ends without metal fixed stop	High-alloy steel	3.5 g	8159470	DYEF-G8-S-M4-Y1
	For size 10			6.9 g	8159472	DYEF-G8-S-M6-Y1
	For size 16			14.6 g	8159473	DYEF-G8-S-M8-Y1
	For size 20			26 g	8159474	DYEF-G8-S-M10-Y1

1) Scope of delivery: 1 cushioning component and 1 threaded sleeve

Shock absorber DYSSG8...Y1F (cushioning -Y12)

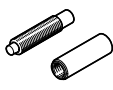
	Description ¹⁾	Cushioning	Material housing	Product weight	Part no.	Type
	For size 6	Self-adjusting	High-alloy steel	3.9 g	★ 8073911	DYSS-G8-2-4-Y1F
					8119980	DYSS-G8-2-4-Y1F-F1A
	For size 10			10.2 g	8111384	DYSS-G8-4-4-Y1F-G2
					8119982	DYSS-G8-4-4-Y1F-F1A-G2
	For size 16			16 g	★ 8073914	DYSS-G8-5-5-Y1F
	8119983				DYSS-G8-5-5-Y1F-F1A	
	For size 20			33 g	★ 8073915	DYSS-G8-7-5-Y1F
					8119984	DYSS-G8-7-5-Y1F-F1A

1) Scope of delivery: 1 cushioning component and 1 threaded sleeve

DYSS...-F1A: Recommended for production plants for manufacturing lithium-ion batteries. More information: www.festo.com/x/topic/bat

Centring sleeve ABAZ

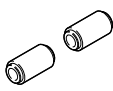
	Description	Material sleeve	Note on materials	Product weight	Part no.	Type
	For size 6	High-alloy stainless steel	RoHS-compliant	2.4 g	8183326	ABAZ-G9-HD-6
	For sizes 10, 16			6.5 g	8183327	ABAZ-G9-HD-10
	For size 20			7.9 g	8183328	ABAZ-G9-HD-20

Centring sleeve ZBH-5

	Description	Material sleeve	Size of pack	Product weight	Part no.	Type
	For sizes 6, 10, 16	Steel	10	1 g	8146543	ZBH-5-B

Accessories

Centring sleeve ZBH-7						
	Description	Material sleeve	Size of pack	Product weight	Part no.	Type
	For sizes 10, 16, 20	Steel	10	1 g	8146544	ZBH-7-B

Centring sleeve ZBH-9						
	Description	Material sleeve	Size of pack	Product weight	Part no.	Type
	For size 20	Steel	10	2 g	8137184	ZBH-9-B